



This is a digital copy of a book that was preserved for generations on library shelves before it was carefully scanned by Google as part of a project to make the world's books discoverable online.

It has survived long enough for the copyright to expire and the book to enter the public domain. A public domain book is one that was never subject to copyright or whose legal copyright term has expired. Whether a book is in the public domain may vary country to country. Public domain books are our gateways to the past, representing a wealth of history, culture and knowledge that's often difficult to discover.

Marks, notations and other marginalia present in the original volume will appear in this file - a reminder of this book's long journey from the publisher to a library and finally to you.

Usage guidelines

Google is proud to partner with libraries to digitize public domain materials and make them widely accessible. Public domain books belong to the public and we are merely their custodians. Nevertheless, this work is expensive, so in order to keep providing this resource, we have taken steps to prevent abuse by commercial parties, including placing technical restrictions on automated querying.

We also ask that you:

- + *Make non-commercial use of the files* We designed Google Book Search for use by individuals, and we request that you use these files for personal, non-commercial purposes.
- + *Refrain from automated querying* Do not send automated queries of any sort to Google's system: If you are conducting research on machine translation, optical character recognition or other areas where access to a large amount of text is helpful, please contact us. We encourage the use of public domain materials for these purposes and may be able to help.
- + *Maintain attribution* The Google "watermark" you see on each file is essential for informing people about this project and helping them find additional materials through Google Book Search. Please do not remove it.
- + *Keep it legal* Whatever your use, remember that you are responsible for ensuring that what you are doing is legal. Do not assume that just because we believe a book is in the public domain for users in the United States, that the work is also in the public domain for users in other countries. Whether a book is still in copyright varies from country to country, and we can't offer guidance on whether any specific use of any specific book is allowed. Please do not assume that a book's appearance in Google Book Search means it can be used in any manner anywhere in the world. Copyright infringement liability can be quite severe.

About Google Book Search

Google's mission is to organize the world's information and to make it universally accessible and useful. Google Book Search helps readers discover the world's books while helping authors and publishers reach new audiences. You can search through the full text of this book on the web at <http://books.google.com/>



Library
of the
University of Wisconsin





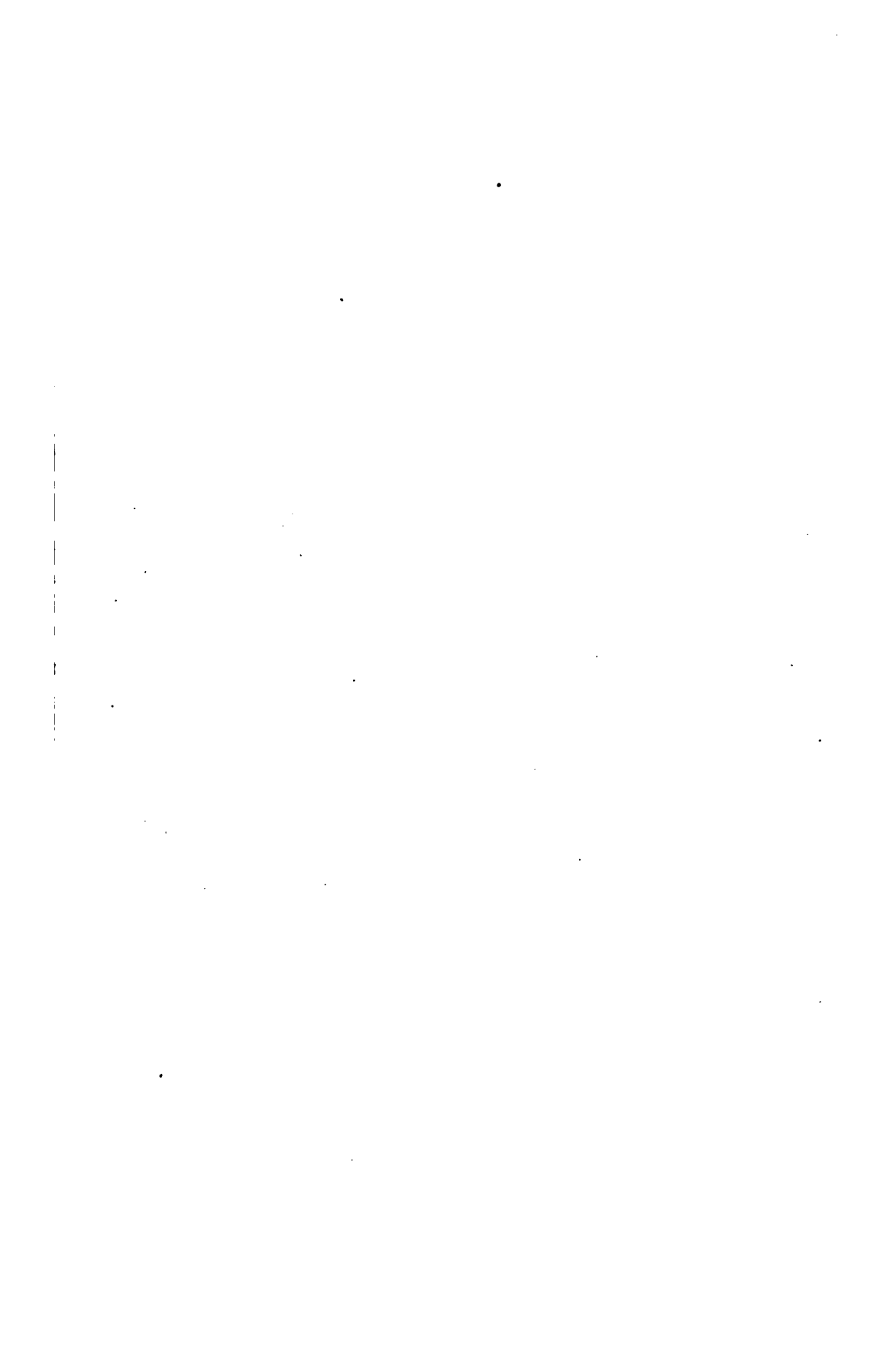

WORKS OF H. M. WILSON

PUBLISHED BY

JOHN WILEY & SONS, INC.

Topographic, Trigonometric and Geodetic Surveying.

Including Geographic, Exploratory, and Military Mapping, with Hints on Camping, Emergency Surgery and Photography. Third Edition, Revised. Illustrated by 18 engraved colored plates and 205 half-tone plates and cuts, including two double-page plates. 8vo, xxx+912 pages. Cloth, \$3.50.

Irrigation Engineering.

Part I. HYDROGRAPHY. *Part II.* CANALS AND CANAL WORKS. *Part III.* STORAGE RESERVOIRS. Sixth Edition, Revised and Enlarged. 8vo, xxix+625 pages; 38 full-page plates and 195 figures, including many half-tones. \$4.00.

IRRIGATION ENGINEERING

BY

ARTHUR POWELL DAVIS, D.Sc.

*Mem. Am. Soc. C.E.; Director and Chief Engineer U. S. Reclamation Service
Author of "Irrigation Works Constructed by
the United States," etc.*

AND

HERBERT M. WILSON, C.E.

*Mem. Am. Soc. C.E.; Former Chief Engineer and Irrigation
Engineer, U. S. Geological Survey; Author of
"Topographic Surveying," etc.*

**SEVENTH EDITION, REVISED AND ENLARGED
TOTAL ISSUE TWELVE THOUSAND**

NEW YORK

JOHN WILEY & SONS, INC.

LONDON: CHAPMAN & HALL, LIMITED

1919

COPYRIGHT, 1896, 1903, 1905, 1909

By HERBERT M. WILSON

COPYRIGHT, 1919

By ARTHUR P. DAVIS and HERBERT M. WILSON

**PRESS OF
BRAUNWORTH & CO.
BOOK MANUFACTURERS
BROOKLYN, N. Y.**

6699863

228333
OCT 17 1919

S'W Y
· W 69
· 3

PREFACE TO SEVENTH EDITION

THE first edition of "Irrigation Engineering," was a pioneer in its field, and quickly took its place as the recognized standard therein, as indicated by its passage through six successive editions.

At the date of the first edition and in fact, some time later, the large irrigation works of engineering interest were mostly in India and Egypt. Mr. Wilson's familiarity with those works, based largely on personal contact with them and their builders and operators, gave the early editions of his work a special value as contributions to western knowledge of this subject.

The subsequent activity in irrigation in other parts of the world, especially in the United States, together with similar developments in related lines of municipal water supply and hydro-electric construction, have presented new problems and evolved new solutions of old ones to such an extent that what might almost be called a new science has been developed, requiring different treatment. Moreover, social, political and economic conditions in America are radically different from those in the Orient, and this imposes very different conditions and limitations upon the practice of irrigation engineering.

Sir William Willcocks, on his visit to America, said he was accustomed to look upon the irrigation industry as one absolutely dependent upon cheap labor like that of Asia and Africa, and that his chief interest in examining American irrigation was to learn how it was that irrigation could be practiced at all in America. American irrigation practice therefore is very different from that of India, and has been largely developed quite recently.

When the undersigned was requested to revise this work for a seventh edition, he undertook the task under the handicap of having his time very fully occupied by official duties, without fully realizing the magnitude of the task.

The material of the sixth edition relating to sewage disposal and irrigation and to subterranean water supply has been liberally used. A few other portions have been used in part, and about 40 per cent of the illustrations have been utilized. In the main the work has been rewritten and rearranged, and much new material has been added.

The principal difference introduced is the treatment of soils, plant food, operation and maintenance, and other lines of work where the duties of the irrigation engineer come in contact with the irrigator, such as the preparation of land, the duty of water and its application to the land. No attempt has been made to treat these nor indeed any other branches of the subject exhaustively, which cannot be done within the limits of such a work as this. It is hoped the results justify their publication, and will continue the usefulness of the work so well pioneered by Mr. Wilson.

In writing and compiling this work much assistance has of course been drawn from existing literature, and references are made to the same at the ends of chapters, and in the text.

A. P. D.

TABLE OF CONTENTS

	PAGE
LIST OF ILLUSTRATIONS.....	xvii

CHAPTER I

INTRODUCTION.....	1
1. History.....	2
2. Extent of Irrigation.....	4
3. Malarial Effects of Irrigation.....	5

CHAPTER II

SOILS.....	7
1. Residual.....	7
2. Alluvial.....	7
3. Eolian.....	7
4. Glacial.....	7
5. Injurious Salts.....	8
<i>a.</i> Percentage in Soils.....	9
<i>b.</i> Resistance of Various Crops.....	11
6. Remedies for Alkali.....	12
<i>a.</i> Leaching.....	12
<i>b.</i> Plowing.....	13
<i>c.</i> Growth of Suitable Plants.....	13
<i>d.</i> Mulching.....	14
<i>e.</i> Gypsum.....	14

CHAPTER III

SOIL MOISTURE.....	16
1. Free Water.....	16
2. Capillary Water.....	16
3. Hygroscopic Water.....	16
4. Capillary Movement.....	17
5. Optimum Water Supply.....	18
6. Wilting Coefficient.....	20
7. Water Required for One Irrigation.....	20

CHAPTER IV

	PAGE
PLANT FOOD.....	22
1. Functions of Water in Plant Growth.....	22
2. Mineral Foods.....	23
3. Fertilizing Effect of Sediments.....	25

CHAPTER V

WATER SUPPLY.....	27
1. Causes of Rainfall.....	27
2. Types of Rainfall.....	32
a. Pacific Type.....	32
b. Rocky Mountain Type.....	35
3. Stream Flow.....	37
4. Laws of Runoff.....	40
a. Drainage Area.....	40
b. Rainfall.....	40
c. Character of Rainfall.....	41
d. Evaporation.....	41
e. Topography.....	41
f. Soil.....	41
g. Geologic Structure.....	41
h. Vegetation.....	41
5. Discharge of Western Streams.....	42
6. Subsurface Water Sources.....	45
a. Rate of Percolation.....	46
b. Permeability of Soils.....	47
7. Artesian Wells.....	48
a. Examples.....	50
b. Capacity.....	51
c. Storage of Artesian Water.....	51
d. Size of Well.....	52
e. Methods of Drilling.....	53
f. Varieties of Drilling Machines.....	53
g. Process of Drilling.....	54
h. Capacity of Common Wells.....	57
8. Tunneling for Water.....	59
9. Other Subsurface Water Sources.....	61
10. Character of Water.....	61

CHAPTER VI

EVAPORATION.....	65
1. Measurement of Evaporation.....	66
2. Amount of Evaporation.....	68
3. Evaporation from Snow and Ice.....	68

CONTENTS

ix

	PAGE
4. Evaporation from Earth.....	69
5. Effect on Water Storage.....	70

CHAPTER VII

PUMPING FOR IRRIGATION.....	73
1. Ground-water Supply.....	74
2. Windmills.....	75
3. Water-wheels.....	78
<i>a.</i> Undershot.....	79
<i>b.</i> Overshot.....	81
<i>c.</i> Turbines.....	82
<i>d.</i> Pelton Water-wheels.....	84
4. Internal Combustion Engines.....	84
5. Hot Air, Gasoline and Alcohol Pumping Engines.....	85
6. Steam Power.....	86
7. Pumps.....	86
8. Direct Pumping.....	90
9. Hydraulic Ram.....	91
10. Air-lift Pumping.....	92
11. Hydro-electric Pumping.....	92
12. Humphrey Direct-explosion Pump.....	95
13. Rice Irrigation.....	97

CHAPTER VIII

IRRIGABLE LANDS.....	90
1. Topography.....	99
2. Soil Survey.....	101
3. Preparation of Land.....	104
<i>a.</i> Clearing.....	104
<i>b.</i> Leveling.....	107
<i>c.</i> Ditching.....	110

CHAPTER IX

APPLICATION OF WATER TO THE LAND.....	111
1. Methods of Irrigation.....	111
<i>a.</i> Free Flooding.....	111
<i>b.</i> Border Method.....	112
<i>c.</i> Furrow Irrigation.....	117
<i>d.</i> Corrugation System.....	119
<i>e.</i> Leveling.....	120
2. Sewage Disposal.....	123
3. Sewage Irrigation.....	127
4. Fertilizing Effects of Sewage.....	128

	PAGE
5. Effects of Sewage Irrigation on Health.....	129
6. Duty of Sewage.....	130
7. Methods of Applying Sewage.....	130
8. Sub-irrigation.....	133

CHAPTER X

DUTY OF WATER.....	137
1. Length of Season.....	138
2. Natural Rainfall.....	138
3. Soil Conditions.....	139
4. Crops Raised.....	139
5. Preparation of Ground and Ditches.....	140
6. Skill of the Irrigator.....	140
7. Care with which Water is Used.....	140
8. Cultivation.....	140
9. Utah Experiments.....	141
10. Agricultural Department Experiments.....	143
11. U. S. Reclamation Service.....	144
12. Inquiry of American Society of Agricultural Engineers.....	148

CHAPTER XI

MEASUREMENT OF IRRIGATION WATER.....	153
1. Gaging Streams.....	153
2. Use of Current Meter.....	157
3. Hydraulic Formulæ.....	163
4. Measurement of Water to the User.....	164
5. Measuring Devices.....	165
a. Weirs.....	166
b. Orifices.....	168
c. Hanna Meter.....	173
d. Azusa Hydrant.....	173
e. Foote Measuring Box.....	173
f. Dethridge Meter.....	175
g. Hill Meter.....	176
h. Grant-Mitchell Meter.....	177
i. Venturi Meter.....	177
j. Venturi Flume.....	178

CHAPTER XII

DRAINAGE.....	184
1. Signs of Seepage.....	185
2. Classification of Drains.....	191
3. Design of a Drainage System.....	193

CONTENTS

xi

	PAGE
4. Location of Drains.....	193
5. Depth.....	195
6. Capacity.....	195
7. Form of Tile.....	196
8. Manholes.....	197
9. Wooden Drains.....	198
10. Cement Pipe Drains.....	198
11. Drainage Works of U. S. Reclamation Service.....	200

CHAPTER XIII

CANALS AND LATERALS.....	202
1. Capacity of Canals.....	202
2. Design.....	205
3. Alinement.....	212
4. Velocity.....	215
5. Lateral Systems.....	217
6. Design of Laterals.....	220
7. Capacity of Laterals.....	221
8. Location of Laterals.....	222
9. Abnormal Leakage from Canals.....	224
10. Construction of Canals.....	227
11. Canal Losses and their Prevention.....	233
12. Seepage Losses.....	234
13. Seepage Formula.....	235
14. Canal Lining.....	236
15. Amount of Return Seepage.....	245

CHAPTER XIV

CANAL STRUCTURES.....	247
1. Classification.....	247
2. Location of Headworks.....	247
3. Canal Headgates.....	248
4. Turnouts.....	263
5. Canal Spillways.....	271
6. Checks, Drops and Chutes.....	284
7. Protection against Erosion.....	290
8. Drainage Crossings.....	293
9. Flumes.....	299
10. Behavior of Various Metals in Presence of Alkali.....	308
11. Culverts.....	314
12. Pipes.....	323
13. Tunnels.....	330
14. Highway Crossings.....	335
15. Sand Traps.....	337

CHAPTER XV

	PAGE
STORAGE RESERVOIRS.....	342
1. Classes of Storage Works.....	342
2. Selection of a Reservoir Site.....	343
3. Geology of Reservoir Sites.....	344
4. Leakage from Reservoirs.....	346
5. Survey of Reservoir Sites.....	353
6. Spillway Provisions.....	354
7. Outlet Works.....	358

CHAPTER XVI

SEDIMENTATION OF RESERVOIRS.....	370
1. Measurement of Sediment.....	371
2. Sediment Rolled on Bottom of Stream.....	373
3. Removal of Silt from Reservoirs.....	376

CHAPTER XVII

DAMS.....	381
1. Conditions of Safety.....	381
2. Diversion Dams or Weirs.....	382
a. Timber Dams.....	382
b. Rectangular Pile Weirs.....	384
c. Open and Closed Weirs.....	386
d. Flashboard Weirs.....	388
e. Indian Type Weirs.....	390
f. Automatic Gates.....	392
g. Automatic Drop Shutters.....	392
h. French Type of Weir.....	394
i. Roller Dams.....	394
j. Crib Dams.....	401
k. Submerged Dams.....	402
3. Storage Dams.....	404
a. Earthen Embankments.....	405
b. Foundations.....	405
c. Springs in Foundations.....	408
d. Safe Slopes.....	409
e. Slope Protection.....	413
f. Percolation.....	417
g. Methods of Construction.....	424
h. Hydraulic Fill.....	426
4. Rockfill Dams.....	436

CHAPTER XVIII

	PAGE
MASONRY DAMS	442
1. Classification.....	443
2. Methods of Failure.....	444
3. Pressures in Masonry.....	444
4. Failure by Sliding.....	447
5. Failure by Overturning.....	449
6. Miscellaneous Forces.....	450
7. Design of Gravity Dams.....	453
8. Design of Arch Dams.....	469
9. Masonry Overfall Dams.....	475
10. Hollow Concrete Dams.....	478
11. Steel Dams.....	487
a. Steel Dam, Ash Fork, Arizona.....	487
12. Foundations for Masonry Dams.....	490
13. Exploring Foundation.....	493

CHAPTER XIX

WATER RIGHTS	496
1. Nature of Property in Water.....	496
2. Riparian Doctrine.....	496
3. Doctrine of Appropriation.....	496
4. Appurtenance to Land.....	500

CHAPTER XX

OPERATION AND MAINTENANCE	502
1. Personnel.....	502
a. Manager.....	502
b. Canal Superintendent.....	502
c. Canal Riders.....	503
d. Hydrographers.....	503
e. Cooperation with Water Users.....	504
2. Economy of Water.....	504
3. Wanton Waste.....	511
4. Rotation Delivery.....	512
5. Basis of Charges.....	514
6. Cultivation.....	515
7. Winter Operation.....	516
8. Maintenance.....	518
9. Erosion of Canal Banks.....	519
10. Silt Deposits.....	520
11. Alkali.....	521

	PAGE
12. Aquatic Plants.....	521
13. Wind Erosion.....	524
14. Noxious Plants.....	525
15. Burrowing Animals.....	525
16. Land Slides.....	526

CHAPTER XXI

INVESTIGATION OF A PROJECT.....	528
1. Reconnaissance.....	528
2. Surveys.....	528
3. Estimates of Cost.....	531
<i>a.</i> Bias.....	531
<i>b.</i> Influence.....	532
<i>c.</i> Inaccurate Data.....	532
<i>d.</i> Omissions.....	532

CHAPTER XXII

SPECIFICATIONS FOR CONSTRUCTION.....	534
1. Specifications for Arrowrock Dam.....	535
2. Contract Specifications of the Reclamation Service.....	547
<i>a.</i> General Requirements.....	547
<i>b.</i> Special Requirements.....	554
3. Standard Paragraphs for Purchase of Material.....	555
4. Earthwork on Canals.....	556
5. Concrete.....	559
6. Structural Steel.....	561
7. Steel Reinforcement Bars.....	562
8. Gray Iron Castings.....	563
9. Malleable Castings.....	564
10. Steel Castings.....	564
11. Cement.....	565
12. Continuous Wood Stave Pipe.....	566
13. Machine Banded Wood Stave Pipe.....	569
14. Laying Machine Banded Wood Stave Pipe.....	571
15. Steel Pipe.....	572
16. Jointed Reinforced Concrete Pipe.....	574
17. Metal Flumes.....	576
18. Steel Highway Bridges.....	579
19. Tunnels.....	584
20. Telephone System.....	586
21. Vitrified Pipe, for Culverts.....	590

CHAPTER XXIII

	PAGE
TABLES.	592
1. Extreme Flood Discharges.....	593
2. Table of Reservoirs.....	598
3. List of Earth and Rockfill Dams.....	599
4. List of High Masonry Dams.....	600
5. Velocity Tables.....	602
6. Tables of Area and Hydraulic Radius.....	611
7. Velocity Heads.....	614
8. Weights of Various Substances.....	615
9. Convenient Equivalents.....	616

LIST OF ILLUSTRATIONS

FIG.	PAGE
1. Mean Annual Precipitation in the United States.....	29
2. Percentage of Annual Precipitation Occurring between April 1st and September 30th.....	30
3. Mean Precipitation Occurring between April 1st and September 30th... ..	31
4. Diagram Showing Effect of Topography on Rainfall in California.....	33
5. Discharge of San Joaquin River at Herndon, California, 1900.....	33
6. Discharge of Neosho River near Iola, Kansas, 1900.....	34
7. Discharge of Boise River at Boise, Idaho, 1899.....	34
8. Discharge of Salt River at McDowell, Arizona, 1899.....	35
9. Discharge of Green River at Green River, Wyoming, 1899.....	35
10. Types of Monthly Distribution of Precipitation in the United States. (After A. J. Henry).....	36
11. Ideal Section Illustrating Condition of Artesian Wells.....	49
12. Ideal Section Illustrating Thinning out of Water-bearing Stratum.....	50
13. Portable Artesian Well Drilling Rig	55
14. Subterranean Water Tunnel and Feed Wells, California.....	60
15. Gathering Cribs, Citizen's Water Company, Denver, Colorado... ..	61
16. Evaporating Pan.....	67
17. Windmill and Reservoir near Garden City, Kansas.....	88
18. Battery of Hydraulic Rams, Yakima Valley, Washington.....	88
19. Undershot Waterwheel.....	89
20. Current Wheel or Noria, Lifting Water from Salmon River for Irrigation.	89
21. Diagram Illustrating Principle of Hydraulic Ram.....	91
22. Scoop Wheel Lifting Water 3½ Feet 60 per Cent Efficient.....	94
23. Direct-explosion Pumping Plant to Raise Irrigating Water 37 Feet.....	95
24. Shoshone Desert before Irrigation.....	100
25. Shoshone Desert after Irrigation.....	101
26. Slip Scraper.....	106
27. Adjustable V for Making Head Ditches.....	107
28. Leveling New Lands, Idaho.....	108
29. Fresno Scraper.....	109
30. Float for Leveling Irrigable Lands.....	110
31. Using Canvas Dam.....	113
32. Steel Dams.....	113
33. Diverting Water from Head Ditch, Canvas Dam, Shoshone Valley, Wyoming.....	114

FIG.	PAGE
34. Drawing Water from Head Ditch through Small Pipes, Riverside, California.....	115
35. Field Prepared for Irrigation by Checks.....	116
36. Border Irrigation in Nevada.....	116
37. Diagram Illustrating Flooding in Rectangular Blocks or Checks. Cowgill.	117
38. Orchard Irrigation by Furrow Method, Yakima Valley, Washington.	118
39. Furrow Irrigation of Cabbages, Yuma, Arizona.....	119
40. Furrow Irrigation on Terraced Hillside, California.....	120
41. Irrigating Orchard by Terraced Basins on Hillside.....	121
42. Orange Trees Irrigated by Check System, Salt River, Arizona.....	122
43. Furrow Irrigation of Orange Grove, Riverside, California.....	122
44. Extent of Percolation from Small Furrows: <i>A</i> , in Loose Loam; <i>B</i> , in Hardpan; <i>C</i> , in Impervious Grit.....	123
45. Irrigating with Large Head by Border Method from Cement Head Ditch, Salt River Valley, Arizona.....	124
46. Irrigating Corn with Sewage, Plainfield, N. J.....	125
47. Furrow Irrigation of Apple Orchard, Idaho.....	125
48. Haskell Current Meter.....	155
49. Price Electric and Acoustic Meters.....	156
50. Water Stage Recorders.....	160
51. Cable Gaging Station with Automatic Continuous Recording Gage.....	161
52. Cable and Car Gaging Station.....	161
53. Wire and Boat Gaging Station.....	162
54. Rectangular Measuring Weir.....	173
55. Foote's Measuring Weir, <i>A</i> ; Water Divisor, <i>B</i>	174
56. Australian Water Meter.....	177
57. Venturi Meter and Recording Device on Lateral Head.....	177
58. Curve Showing Fluctuation of Ground Water and Application of Irrigation Water in the Rio Grande Valley. After Burkholder.....	187
59. Curve Showing the Seasonal Fluctuation and Yearly Rise of Ground Water in Boise Valley, Idaho. After Burkholder.....	188
60. Curve showing Rise of Ground Water before Construction of Drains and Effect of Drains, Boise Valley, Idaho. After Burkholder.....	189
61. Excavating Trench for Tile Drain, Montana.....	192
62. Dragline Excavator on Drainage Work, Idaho.....	192
63. Cross-sections of Interstate Canal, North Platte Valley, Nebraska.....	204
64. Canal Cross-sections for Varying Bed Widths.....	206
65. Various Canal Cross-sections.....	206
66. Rock Cross Section, Turlock Canal.....	207
67. Rock Cross-section, Umatilla Canal.....	208
68. Cross-section of Calloway Canal in Sand, Showing Sub-grade.....	211
69. Typical Section of Lined Canal.....	211
70. Tunnel and Canal Sections, Tieton Main Canal.....	213
71. Diagram Illustrating Distributary System.....	218
72. Cavity Developed in Canal Bed, Flathead Reservation, Montana.....	225
73. Cave Developed in Bottom of Canal, Flathead Indian Reservation.....	226
74. Building Lateral in Montana with Ditching Machine.....	228

LIST OF ILLUSTRATIONS

xix

FIG.	PAGE
75. Building Irrigation Lateral in Montana with Elevating Grader.....	228
76. Building Canal with Elevating Grader.....	229
77. Building Canal with Fresno Scrapers.....	233
78. Cross-section of Santa Ana Canal, Lined with Boulders Set in Cement...	237
79. Check Gates and Canal Lined on One Side. Interstate Canal.....	239
80. Semicircular Concrete Lined Section of Main Canal, Umatilla Valley, Oregon.....	239
81. Concrete Lining Truckee-Carson Canal, Nevada.....	240
82. Reinforced Concrete Lining, Tieton Canal, Washington.....	241
83. Transition from Rock to Earth Cross-section Lined Canal.....	242
84. Lining Canal with Concrete, Idaho.....	244
85. Cross-section of Corbett Weir, Shoshone Project, Wyoming.....	248
86. Plan of Corbett Dam and Headworks, Shoshone Project, Wyoming.....	249
87. Wooden Gate, Leasburg Canal Regulator, Rio Grande, New Mexico.....	250
88. Iron Regulator Gate, Minidoka Canal, Idaho.....	250
89. Cast-iron Sluice-gate, Interstate Canal, Nebraska-Wyoming.....	251
90. Diversion Works, Lost River, Oregon.....	252
91. Regulator Gates, Laguna Weir, Colorado River.....	253
92. Inclined, Falling Regulator Gates, Goulburn Canal, Australia.....	254
93. Sunnyside Dam, Canal and Headworks, Yakima Valley. Headgates in Line with Dam.....	255
94. Regulating Gates and Sluice Gates at Right Angles to Each Other, Yuma Main Canal, California.....	256
95. Whalen Diversion Dam and Headgates, Normal to Dam, North Platte River, Wyoming.....	257
96. Sprague River Dam, Klamath Indian Reservation, Oregon.....	258
97. Plan and Elevation of Headworks, Interstate Canal, North Platte River, Wyoming.....	259
98. Jackson Lake Dam, Downstream Face, Wyoming.....	260
99. Headgates and Sluice Gates, Montrose and Delta Canal, Uncompahgre Valley, Colorado. Obtuse angle.....	260
100. Division Gates and Drops on Tsar Canal near Byram Ali, Murgab Valley, Turkestan.....	261
101. Headworks of Sultan Yab Canal at Sultan Bend Reservoir on Murgab River, Turkestan.....	261
102. Cross-section and Elevation of Regulator Gates, Folsom Canal.....	262
103. Wooden Head to Lateral, Sun River Canal, Montana.....	263
104. Concrete Check and Farm Turnout with Inclined Valve.....	264
105. Cast-iron Valve on Small Lateral Turnout.....	265
106. Standard Turnout, Vitrified or Concrete Pipe, U. S. R. S.....	266
107. Standard Turnout Box Concrete, U. S. R. S.....	267
108. Reinforced Concrete Turnout with 10 Foot Drop, Garland Canal, Wyo- ming.....	268
109. Cast-iron Gates for Laterals, Interstate Canal, Wyoming-Nebraska.....	269
110. Reinforced Concrete Turnout for Lateral.....	270
111. Lateral Headgates, North Platte Valley, Nebraska.....	271
112. Standard Spillway, Length of Weir less than 100 Feet. U. S. R. S.....	272

FIG.	PAGE
113. Standard Spillway, Length of Weir over 100 Feet. U. S. R. S.	273
114. Keno Canal Spillway, Klamath Falls, Oregon.....	274
115. Plan and Section of Siphon Spillway, on Canal in Colorado Valley, Cal.	276
116. Spillway, Fort Shaw Canal, Montana.....	277
117. Standard Sluiceway, Lower Yellowstone Canal, Montana.....	278
118. Wasteway, Lower Truckee Canal, Nevada.....	279
119. Tieton Main Canal, Lined Section.....	281
120. Concrete Drop with Water Cushion, Truckee-Carson Canal, Nevada	283
121. Notch Drop, Chenab Canal, India.....	284
122. Cross-section of Fall. Bear River Canal.....	285
123. Notch Drop, Interstate Canal, Wyoming-Nebraska.....	286
124. Timber Drop, Lower Yellowstone Laterals, Montana.....	287
125. By-pass Feeder from Upper to Lower Canal, Umatilla Project, Oregon	288
126. Cylinder Drop on Franklin Canal, Rio Grande Valley, Texas.....	289
127. Series of Concrete Drops on South Canal, Uncompahgre Valley, Colorado.	290
128. Concrete Chute and Stilling Basin, Boise Valley, Idaho.....	291
129. Reinforced Concrete Chute, Okanogan Project, Washington.....	294
130. Pipe Inlet, Reno Coulee, Lower Yellowstone Canal, Montana.....	294
131. Elevation and Cross-section of Iron Flume on Corinne Branch, Bear River Canal, Utah.....	295
132. Standard, Reinforced, Concrete Flume, Reclamation Service.....	296
133. Circular Reinforced Concrete Flume and Trestle, Tieton Canal, Wash- ington.....	297
134. Headworks of Cavour Canal, Po River, Italy.....	298
135. Brick Aqueduct Carrying Cavour Canal, Po Valley, Italy.....	298
136. Bench Flume, High Line Canal, Colorado, Spillway in Foreground.	300
137. View of Solani Aqueduct, Ganges Canal, India.....	301
138. Cross-section of San Diego Flume, California.....	302
139. Cross-section of Stave and Binder Flume, Santa Ana Canal, California.	302
140. Section through Reinforced Concrete Aqueduct, Interstate Canal, Wyom- ing-Nebraska.....	303
141. Mill Creek Flume, Steel Frame and Bridge, Santa Ana Canal, Cal.	304
142. Steel Flume, Tieton Distribution System, Yakima Valley, Washington.	306
143. Steel Flume Crossing Eight-mile Creek, Boise Valley, Idaho.....	307
144. Half Longitudinal Section, Reinforced Concrete Aqueduct, Interstate Canal, Wyoming-Nebraska.....	308
145. Reinforced Concrete Aqueduct, Spring Canyon, Interstate Canal, Wyom- ing-Nebraska.....	310
146. Concrete Flume, Spanish Fork Valley, Utah, Showing Warped Transition from Canal to Flume.....	310
147. View of Ranipur Superpassage, Ganges Canal, India.....	311
148. Continuous Wood Stave Pressure Pipe, Idaho Irrigation Company's Canal.....	312
149. Elevation and Cross-section of Nadrai Aqueduct, Lower Ganges Canal.	313
150. Reinforced Concrete Culvert, Lower Yellowstone Canal, Montana.	315
151. Burn's Creek Superpassage, Lower Yellowstone Canal, Montana.	316
152. Inlet to Rawhide Siphon, Interstate Canal, Wyoming-Nebraska.....	317

LIST OF ILLUSTRATIONS

xxi

FIG.	PAGE
153. Siphon Crossing under Rawhide Creek, Interstate Canal, Wyoming-Nebraska	317
154. Reinforced Concrete Twin Siphon, Interstate Canal, Wyoming-Nebraska.	319
155. Reinforced Concrete Twin Siphon, Fox Creek Crossing, Lower Yellowstone Canal, Montana.....	320
156. Main Canal, Concrete Lined, Okanogan Project, Washington.....	321
157. Happy Canyon Steel Flume, Uncompahgre Valley, Colorado.....	322
158. Steel Bridge and Wood Stave Pressure Pipe, Yakima Valley near Prosser, Washington.....	327
159. Steel Forms and Reinforcement for Concrete Pressure Pipe, Boise Valley, Idaho.....	328
160. Removing Inside Steel Forms from Concrete Pressure Pipe.....	329
161. Manhole and Concrete Collars on Concrete Pressure Pipe, Boise Valley, Idaho.....	329
162. High Line Canal, Spanish Fork Valley, Utah, Covered to Protect Against Land and Snow Slides.....	336
163. Headgates, Sluiceways and Sand Basins, High Line Canal, Spanish Fork, Utah.....	336
164. Cross-section of Sandbox, Santa Ana Canal.....	338
165. Sandbox, Leasburg Canal, Rio Grande Valley, New Mexico.....	339
166. Standard Sluiceway and Sandgate, Lower Yellowstone Canal, Montana-North Dakota.....	340
167. Curves of Seepage from Deerflat Reservoir Showing Improvement with Use.....	348
168. Gatehouse Conconully Dam, Washington.....	360
169. Vertical Lift Outlet Gate, Fay Lake Reservoir, Arizona.....	361
170. Valve Plugs: A, Sweetwater, and B, Hemet Dams.....	362
171. Outlet Works Lahontan Dam, Carson River, Nevada.....	363
172. Section of Balanced Valve, Arrowrock Dam, Boise River, Idaho.....	365
173. Outlet Conduit Keechelus Dam, Washington, Showing Concrete Cut-off Collars, Core Wall and Track for Backfilling on Left.....	366
174. Butterfly Valve, Minatare Dam, Nebraska.....	366
175. Elevation and Section of Butterfly Valve.....	367
176. Needle Valve in Outlet Conduit, Needle Dam, North Platte Valley, Nebraska.....	368
177. Trap for Measuring Sand Rolling on Bottom of Stream.....	375
178. Folsom Canal, View of Weir and Regulator.....	383
179. Folsom Canal, Plan and Cross-section of Weir.....	385
180. Plan and Section of Laguna Dam, Colorado River.....	385
181. Cross-section of Lower Yellowstone Weir, Montana.....	387
182. Kern River Diversion Weir, Head of Calloway Canal.....	389
183. Cross-section of Open Weir, Calloway Canal.....	390
184. Cross-section of Indian Weirs.....	391
185. Cross-section of Shutter on Soane Weir, India.....	392
186. Automatic Drop Shutter, Betwa Weir, India.....	393
187. Falling Sluice Gate, Soane Canal, India.....	395
188. View of Open Weir on River Seine, France.....	396

FIG.	PAGE
189. View of Goulburn Weir, Australia.....	397
190. View of Rolling Dam, Grand River, Colorado.....	398
191. Section through Body of 70-foot Roller Dam, Grand River, Colorado.....	399
192. Section through Driven Hand 70-foot Roller.....	400
193. Cross-section of Bear River Crib Weir.....	401
194. Cross-section of Upper Coffey Dam, Arrowrock Dam, Boise River, Idaho.....	402
195. View of San Fernando Submerged Dam.....	403
196. Sections of Owl Creek Storage Dam, Belle Fourche Valley, South Dakota.....	406
197. Plan of Lahontan Dam, Carson River, Nevada.....	408
198. Elevation and Cross-section of Strawberry Dam, Utah.....	410
199. Section of Kachess Dam, Yakima Valley, Washington.....	414
200. Profile, Plan and Section of Upper Deerflat Embankment, Boise Valley, Idaho.....	416
201. Owl Creek Dam near Belle Fourche, South Dakota, showing Concrete Paving.....	418
202. Upper Deerflat Embankment Showing Beaching of Gravel Slope.....	418
203. Wheeled Scraper.....	425
204. Cold Springs Dam under Construction, Umatilla Valley, Oregon.....	427
205. Grooved Concrete Roller.....	427
206. Dam at Necaxa, Mexico.....	428
207. Trestles on Conconully Dam, Washington, Showing Method of Hydraulic Construction.....	431
208. Cross-section of Bumping Lake Dam, Naches River, Washington.....	433
209. Section of Sherburne Lakes Dam showing Gravel Core and Drains to Provide for Seepage Water.....	434
210. Sections of Conconully Dam, Salmon Creek, Washington.....	435
211. Rockfilled Dam, Snake River, Minidoka Project, Idaho.....	436
212. Plan and Cross-section of Bowman Dam.....	437
213. Elevation, Plan and Cross-section of Castlewood Dam, Colorado.....	438
214. Lower Otay Rockfilled Dam, California.....	439
215. Elevation and Cross-section of Walnut Grove Dam.....	440
216. Rockfilled Steel Core Dam, Lower Otay, California.....	440
217. Section of Elephant Butte Dam, Rio Grande, New Mexico.....	454
218. Elephant Butte Dam, Cableways and Mixing Plant, Rio Grande, New Mexico.....	455
219. Elevation of Arrowrock Dam, Boise River, Idaho.....	458
220. Maximum Section of Arrowrock Dam.....	459
221. Plan of Arrowrock Dam, Boise River, Idaho.....	460
222. Elephant Butte Dam showing Construction in Alternate Columns.....	462
223. Cross-section of Periar Dam, India.....	463
224. Cross-section of New Croton Masonry Dam, New York.....	464
225. Plan, Cross-section and Outlet Sluices, San Mateo Dam, California.....	466
226. Plan of Roosevelt Dam, Arizona.....	467
227. Maximum Cross-section of Roosevelt Dam, Arizona.....	468
228. Pathfinder Dam, North Platte River, Wyoming, Lower Face Showing Concrete Ladder and 6500 Second-feet of Water Discharging from Tunnel.....	470

LIST OF ILLUSTRATIONS

xxiii

FIG.	PAGE
229. Upper Otay Masonry Dam, California.....	471
230. Meerallum Dam, India. Plan and Sections of One Arch.....	472
231. Cross-section of Bear Valley Dam, California.....	473
232. Plan and Elevation of Bear Valley Dam, California.....	473
233. Shoshone Dam, Wyoming. Analysis of Pressures.....	474
234. Cross-section of New Holyoke Weir, Mass.	475
235. Cross-section of Granite Reef Weir, Salt River, Arizona.	476
236. Cross-section of Norwich Water Company's Weir.....	477
237. Leasburg Diversion Weir, Rio Grande Valley, New Mexico.	478
238. Cross-section of Old Croton Dam, New York.....	479
239. McCall's Ferry Dam, Susquehanna River, Pa., Showing Steel Forms Used in Construction.....	480
240. Cross-section of La Grange Overflow Masonry Dam, California.....	480
241. Granite Reef Dam, Salt River, in Flood, Showing Hydraulic Jump...	481
242. East Park Reservoir Spillway, Orland Project, California.....	482
243. Diversion Dam, East Park Feed Canal, Orland Project, California.	482
244. Elevation, Plan and Section of Three Miles Falls Dam, Umatilla River, Oregon.....	483
245. East Park Multiple Arch Spillway, Orland Project, California.....	485
246. Cross-section of Iron Weir, Cohoes, New York.....	486
247. Cross-section of Reinforced Concrete Weir, Theresa, New York.....	486
248. Steel Dam, Ash Fork, Arizona.....	488
249. Iron Face Rollerway Weir, Cohoes, New York.....	489
250. Standard Horseshoe and Circular Sections of Conduits.....	612

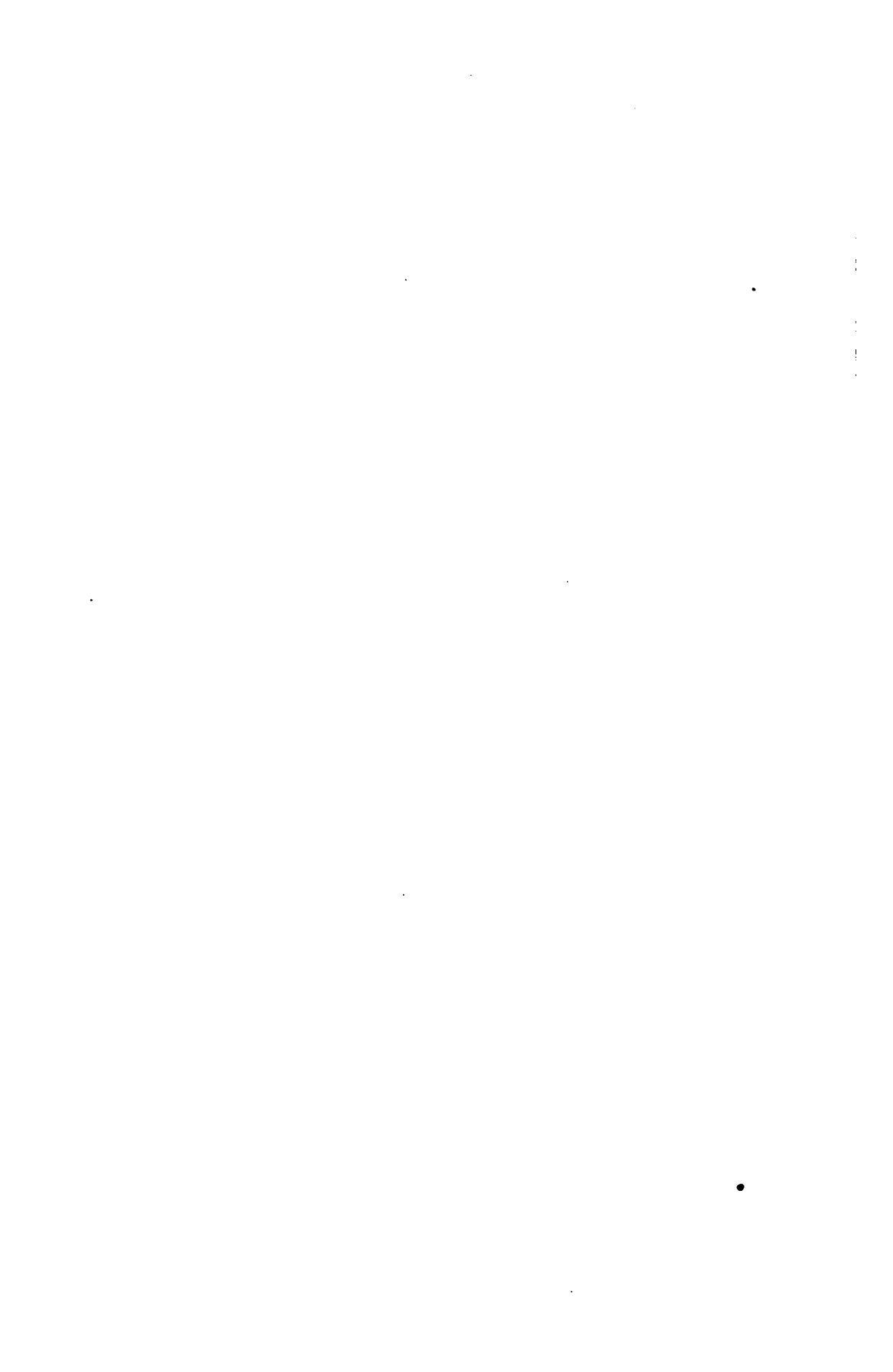

IRRIGATION ENGINEERING

CHAPTER I

INTRODUCTION

IRRIGATION is the artificial application of water to soil to assist in the production of crops. Its most familiar form is the sprinkling of lawns in both arid and humid regions, and the contrast between the watered and unwatered lawns, even in a humid climate, illustrates its benefits. Wherever practiced, it is supplementary to the natural rainfall.

Scientific irrigation involves a knowledge of the available water supply, its conservation and application to the land, the characteristics and needs of the different types of soil, and the requirements of the various crops to be produced.

In general, irrigation is most extensively practiced in arid regions where agriculture without it is precarious or impracticable, but it is also applied to lands of the semi-arid regions to increase the yield, and to special crops in humid regions, such as rice, sugar cane, lawns, garden flowers and vegetables. In fact there are comparatively few regions so free from occasional drouth that irrigation would not be profitable if it could be cheaply provided.

The surface of the earth is composed of land and water, the latter being roughly three-fourths of the area and not habitable by man. Of the remaining one-fourth or land area, more than half is either too cold or too rocky for cultivation, and of the remainder the major portion is too arid for the production of crops, and only in part useful for grazing or other purposes. Even of the humid area, a very large part is in tropi-

cal Africa and South America, ill-adapted to civilization and development by means known at present.

Thus the area naturally available for cultivation is a very small proportion of the whole, but can in places be increased by artificially applying water to the soil where nature fails to do this.

An irrigated region has certain advantages over a humid region in the production of crops. There is much advantage in being able to apply the water at just the time and in just the quantity needed, and to withhold it at will. The soils of arid regions are apt to be better supplied with the mineral plant foods which have not been leached out by excessive rains, and the great promoter of life and growth, sunlight, is more intense and constant in an arid than in a humid region. If sufficient care and skill be applied to secure the full benefit of these important advantages, the acreage yields under irrigation may be made far larger than under natural precipitation.

History.—Agriculture by irrigation antedates recorded history, and is probably one of the oldest occupations of civilized man; but the time and place of its origin are unknown. Various countries in Asia, Africa, Europe and America exhibit evidences of ancient irrigation works of prehistoric origin and unknown antiquity.

The earliest records of Assyria, Babylon, Egypt, Persia, India, China, and practically every country of antiquity, bear testimony to ancient and well-developed practices of irrigation.

At the time of the Spanish conquests in America, extensive and well-built irrigation systems existed, antedating the earliest traditions of the peoples using them. Traces of such works were found not only in South and Central America, but also in Southern Arizona, New Mexico, Colorado, and California.

As a modern activity of the Anglo-Saxon race, irrigation in the United States seems to have had its origin in the Salt Lake Valley of Utah about the middle of the Nineteenth Century at the present location of the city of Salt Lake. The early settlers of California, Arizona and New Mexico extended the previous practices of the Spaniards and Indians in those States.

During the early history of American irrigation farmers and groups of farmers naturally confined their efforts mainly to diverting small streams upon adjacent valleys, where the slope of the country and the topography was such as to make the work easy and cheap. With the values of western land then existing no expensive enterprise was practicable. Such development proceeding for nearly half a century, widely distributed over the arid region, irrigated in the aggregate a large area of land. The farmers employed the cheapest class of construction and seldom counted their own time in computing costs, which are hence reported very low.

As land values increased and the easier projects had been developed more and more difficult ones were taken up, sometimes successfully and sometimes not. As the more difficult problems were attacked, corporate capital and the district system were employed and such projects as they could handle were gradually developed. The inherent difficulties, however, did not admit of much profit to the investor. In fact, in a majority of the cases, the investors lost a large part of their capital, to say nothing of interest and profits, and though the general benefits in the development of the country were great and lasting, the losses made it more and more difficult to enlist capital in further irrigation enterprise.

Various National laws were passed from time to time to encourage the irrigation of arid lands, the Desert-Land Act and the Carey Act, with their various modifications, being the most conspicuous examples, but all depending upon the investment of private or corporate capital for actual construction. A great deal was accomplished under these acts in spite of the great and growing difficulties.

The increasing difficulty of carrying out many large projects led to the passage in 1902 of the Reclamation Act, with the avowed object of enlisting National funds for the development of projects not feasible by private, corporate, district, or State enterprise.

The acts provided for the segregation in a special fund of the receipts from the sale of public lands in the sixteen Western

States, and the investment of this fund in irrigation works, to be returned by the beneficiaries in small installments. Under the operations of this act more than a million acres have been irrigated, the reclamation of which would not have been feasible for private enterprise for a long time if ever.

Extent of Irrigation.—The total area irrigated in various countries is estimated as follows:

France	6,000,000
India	40,700,000
Italy	3,460,000
Russian Empire	8,000,000
Java	3,000,000
Egypt	5,350,000
Japan	7,000,000
Philippines	130,000
Australia	450,000
Canada	400,000
Hawaii	200,000
Argentina	1,000,000
Peru	640,000
Siam	1,750,000
United States	15,000,000
Total	93,080,000

In addition there are millions of acres irrigated in China, Algeria and other countries, probably increasing the total to nearly 100,000,000 acres.

Returns of Irrigation.—The returns of irrigation vary greatly with the soil, climate, degree of aridity, and the nature and value of the crops which can be grown. Thus in the semi-humid and humid regions irrigation may serve only as an insurance on the crops by providing against possible deficiencies in rainfall. In Utah and neighboring States where only grain, hay, potatoes, and kindred crops can be grown, and water is not economically handled, the returns from irrigation are far less than in southern California and Arizona, where valuable citrus fruits can be cultivated.

Irrigation adds to the general wealth of the country by increasing the amount of its agricultural products. It results in the conversion of barren and desert lands into delightful homes, and aids in the general development of the other resources of the region in which it is practiced, as mining, lumbering, grazing, etc. One of the great advantages of irrigation is that it becomes practically an insurance on the production of crops. Its practice may not be necessary in the semi-humid or humid regions, but even there occasional drouths occur and crops are lost. Where an irrigation system exists in such cases, it may be called into requisition once or twice in the course of the year, and may save vast sums which would otherwise be lost by the destruction of crops.

Malarial Effects of Irrigation.—In some localities, irrigation has been denounced as a menace to the health of the community because of the creation of swamps and their malarial effects. From careful researches, both by a committee to the Indian Government and by Dr. H. O. Orme of the California State Board of Health, it appears that these evil effects have been exaggerated, and may be avoided by more sparing use of water and by proper drainage. Where the natural drainage is of the best, the soil sandy or gravelly and open to a great depth, the water used in irrigation sinks into the ground or drains off, and the use of irrigation water does not breed malarial mosquitoes. On the other hand, in low-lying, comparatively level lands where the soil is heavy, the slopes slight, and the underdrainage poor, it is undoubtedly true that irrigation has developed various disorders, by raising the subsurface water-plane, thus causing the water to stand in swamps or stagnant pools, breeding malarial mosquitoes.

Malarial effects are not attributable directly to the results of irrigation where economically and properly practiced, but are frequently due to carelessly constructed canal works having intercepted the natural drainage, thus forming swampy tracts. When care is taken to irrigate economically land which has such slopes and natural drainage as to prevent waterlogging, no injurious effects will result from irrigation; furthermore

when malarial influences are developed by irrigation their effect is local, and can be corrected by drainage.

If wholesome water and not open-ditch water be provided for domestic uses, prejudicial effects of irrigation are largely averted. In such climates as will encourage its growth it appears that the *Eucalyptus globulus* has proved beneficial in mitigating the malarial effects of irrigation waters, chiefly because of the great absorbing and transpiring power due to its rapid growth. The destruction of mosquito larvæ will entirely remove the source of malarial disorders.

REFERENCES FOR CHAPTER I

- FORTIER, SAMUEL. Use of Water in Irrigation. McGraw-Hill Book Co., New York.
- WIDTSON, JOHN A. Principles of Irrigation Practice. Macmillan Company, New York.
- WILSON, H. M. Irrigation in India, 12th Ann. Report U. S. Geological Survey, Washington.
- JAMES, GEORGE WHARTON. Reclaiming the Arid West. Dodd, Mead & Co., New York.
- HENNY, D. C. Federal vs. Private Irrigation. *Engineering News*, Jan. 15, 1915.
- NEWELL, F. H. The Human Side of Irrigation. *Engineering Record*, August 29, 1914.

CHAPTER II

SOILS

ARABLE soils may be divided into four general classes with respect to their origin:

(1) Residual; (2) Alluvial; (3) Eolian; and (4) Glacial.

1. **Residual soils** are the product of the disintegration of rock in place under the action of air, moisture, frost and vegetation, all of which act upon most natural rocks. As moisture and vegetation are most abundant in humid regions, residual soils are there most general in consequence.

2. **Alluvial soils** are the deposits of sedimentation in bodies of still water, and of flowing streams upon their banks by overflow, and by the accumulation of sediments in deltas at and near their mouths.

3. **Eolian soils** are those which have been deposited by wind action, and are common in the neighborhood of broad shallow streams or lakes, whose fluctuating waters leave broad bare stretches frequently exposed to wind action which removes and redeposits the surface with a sorting result, different from that of water.

4. **Glacial soils** are the deposits by glaciers of the products of glacial erosion and some other agencies.

All these classes differ widely in the methods and results of the mixing process, but many soils are the products of two or more of the agencies mentioned, and the original condition of the soil is generally modified superficially by the action of wind and rain.

There are generally certain important differences between the soils of arid and humid regions, due to the difference of humidity. In humid regions the abundance of moisture tends to leach out the more soluble constituents of the soil, and the

same cause promotes the luxuriant growth of vegetation, so that the tendency is to remove the soluble minerals, and to accumulate vegetable mold. As most alkaline minerals are highly soluble, and are hence easily leached out of the soils of humid regions, and as the decay of vegetation produces certain organic acids, there is often a resulting acidity of soil in humid regions.

In arid regions, on the contrary, the lack of moisture leaves the soluble minerals largely in the soil. These soils are therefore likely to contain much larger percentages of the various salts of potassium, sodium, and magnesium, as well as the less soluble phosphates, most of which are valuable plant foods.

The arid condition being unfavorable to vegetable growth, the arid soils are generally deficient in vegetable mold, or humus, and sometimes this must be supplied before the soil becomes fertile. Most alkaline salts are soluble in water, and therefore these occur more generally in arid than in humid regions, and the soils of arid regions are more likely to be alkaline than acid, and the alkalis are sometimes present to an extent injurious to vegetation; an excess of the salts of sodium being especially harmful.

5. Injurious Salts, or Alkali.—While the aridity of western soils has its advantages in retaining the soluble salts in the soil, and thus preserving the plant foods, it sometimes happens that one or more soluble elements occurs in such abundance as to be injurious to vegetation. This is most important in the case of some of the so-called alkaline salts, as the carbonate, chloride and sulphate of sodium, and a few other salts less abundant and harmful.

Alkalis found in natural soils are usually composed of a variety of salts, which possess widely different properties with relation to plant life.

The most harmful alkali, and the one which becomes harmful with the least quantity is carbonate of sodium, Na_2CO_3 . This has caustic qualities, and in the presence of organic matter takes on a dark brown color, from which it is often called "black alkali."

Where the carbonates predominate, the presence of an average of one-tenth of one per cent of alkali in the root zone of any soil is disastrous to the growth of most useful crops, and for the best results the quantity should be much less. A somewhat greater quantity of chlorides and a still greater percentage of sulphates can be tolerated.

In general a soil having less than five-hundredths of one per cent of soluble salts is acceptable, and one having more than five-tenths of one per cent of soluble salts is infertile. Between these limits, the fertility depends mainly upon the character of the salts and of the soil.

Lyon and Fippin have compiled from analyses made by the U. S. Bureau of Soils, the following percentage composition of Various Natural Soils:

TABLE I

	YAKIMA VALLEY, WASH., MEADOW LAND			BOISE VALLEY, IDAHO		GREAT FORKS N. DAKOTA		BILLINGS, MONTANA	
	Surface foot	Second foot	Third foot	Surface foot	Surface Deposit	Alkali Crust	12-36 ins.	Crust 1 in.	Sur- face 10 ins.
KCl.....		5.6	7.8	8.1	1.8	1.8	5.5
K ₂ SO ₄								1.6	21.4
K ₂ CO ₃	8.7	9.7	8.6						
Na ₂ SO ₄				16.5	67.7			85.6	35.1
Na ₂ CO ₃	66.9	13.9	6.6	41.6	.1			trace	7.3
NaCl.....					17.6	26.2		.6	trace
MgSO ₄8	6.2	41.5	24.3	8.9	4.1
MgCl ₂	13.3					9.2	8.8		
CaCl ₂	1.9								
NaHCO ₃		36.7	45.3	31.3	.7	1.5	4.3	.7	22.1
CaSO ₄	9.1	1.9	6.2	.6	5.9	19.8	57.1	2.7	10.1
Ca(HCO ₃) ₂		16.5	13.2						
Mg(HCO ₃) ₂		12.6	12.3						
KHCO ₃				1.1					

DeVries has shown that the presence of large amounts of salts dissolved in the water in contact with the roots of plants causes a shrinkage of the lining of the cells which, if persistent, causes the plant to wither and die. In addition to this, the car-

bonates of the alkalis have a corroding effect directly upon the plant tissues. An excess of alkaline salts sometimes encourages various plant diseases, and reduces the efficiency of tillage.

The various crops are differently affected by the presence of alkali. Some native grasses, as salt grass and sacaton, are the most resistant, and of the cultivated grasses, timothy and alfalfa are the most tolerant. Of the cereals, barley is the most tolerant, and oats next. Sugar beets are more tolerant of alkali than most other root crops and cereals.

The point at which alkalis become injurious is indefinite, and varies not only with the crop, but still more with the character of the salt, the character of the soil and the presence of moisture. When the water content of the soil is large the dilution of the salt has an ameliorating effect, and as the soil dries out the solution becomes more concentrated, and hence more injurious. Clay and loam soils, by reason of their greater water-holding qualities, may carry more alkali without injury to plants than a sandy one.

In general the salts of sodium are more injurious than others, carbonates are more injurious than chlorides, and chlorides are more injurious than sulphates. Potassium, calcium and phosphorus are all valuable plant foods, and it is seldom that salts of these elements are present in quantities injurious to vegetation.

Alkali is injurious of course only when it is in close contact with the tissues of the plant, that is when present in the root zone. The salts outside the root zone are harmless so long as they remain there. An excellent fertile soil containing a small percentage of alkaline salts may be ruined by the concentration of salts in the surface layers of soil by the prolonged upward movement of water carrying the salts in solution and its evaporation from the surface. Wherever the water table is raised by percolation from higher lands and brought within a few feet of the surface capillarity does the rest, by establishing an upward movement from the water table to supply the draft of evaporation, and whatever salts the soil contains are carried to the surface in solution, and left there as the water evaporates. This concentration at the surface may be fatal

to young plants whose roots are very delicate and are near the surface, while older plants of the same variety may not be injured because their roots are deeper where the salts are less concentrated, and because the older plants are more vigorous.

On the other hand, the rising water table may injure deep-rooted plants before the salts are sufficiently concentrated at the surface to injure those of shallow roots, and thus for a time a high water table may be fatal to alfalfa, while the cereals thrive on the same ground. This condition is usually temporary, however, as the tendency of a very high water table is to accumulate soluble salts near the surface.

On account of the wide variety of possible conditions affecting results it is impossible to lay down exact rules governing the amount of alkali that is injurious to vegetation. This varies with the salt and the infinite combinations of salts, with the crop, with the character of soil, with the moisture conditions, and with some minor circumstances. Any rule must therefore be regarded as only a general indication, and not an accurate guide. The following may be taken as rough limits:

Sodium carbonate, Na_2CO_3	0.1 per cent
Sodium chloride, NaCl	0.5 " "
Sodium sulphate, Na_2SO_4	1.0 " "

If any of these salts exceed these limits some of the ordinary crops will be injured and the soil is unsuitable for fruit.

Resistance to Alkali.—The investigations of Loughridge and others indicate relative alkali resistance of common crops roughly in the following order:

- | | |
|------------------|------------------|
| 1. Salt grass | 10. Barley |
| 2. Salt bush | 11. Radish |
| 3. Date palm | 12. Sunflower |
| 4. Modiola | 13. Bean |
| 5. Sorghum | 14. Pea |
| 6. Sugar beets | 15. Grape |
| 7. Hairy vetch | 16. Artichoke |
| 8. Kafir corn | 17. Olive |
| 9. Alfalfa (old) | 18. Gluten Wheat |

- | | |
|---------------------|----------------|
| 19. Carrot | 30. Onion |
| 20. Wheat | 31. Pear |
| 21. Orange | 32. Goats' rue |
| 22. Celery | 33. Canaigre |
| 23. Almond | 34. Mulberry |
| 24. Lupine | 35. Prune |
| 25. Rye | 36. Peach |
| 26. Oats | 37. Apple |
| 27. Fig | 38. Apricot |
| 28. Alfalfa (young) | 39. Lemon |
| 29. Potato | |

6. Remedies for Alkali.—Where a field once fertile has been made sterile by the rise of ground water, bringing alkaline salts to the surface, there is no effectual remedy except to lower the ground water by means of deep drains.

a. Leaching.—If the condition is of long standing the alkali may have accumulated in the upper layers of the soil to such an extent that the land remains infertile after the water table has been lowered. Indeed the ground may then become still more sterile, and plants growing thereon may die, since, as we have already seen, a given percentage of alkali in the soil is less harmful with abundance of water than under conditions of less moisture. In such cases the soil must be leached of its superfluous salts. This is accomplished by first providing adequate under drainage, and following this with copious irrigation, keeping the surface layers of soil saturated with water for protracted periods, so that there is a continuous downward movement of gravity water which escapes through the drains. If this process is continued long enough it will effectually and permanently remove the superfluous salts, and of course much plant food at the same time.

The time required will depend upon the freedom with which the water passes through the soil, the amount of salt to be removed, and some minor conditions, so that no rule can be given, but this should not consume more than one year, and under some conditions, it may be possible to produce some shallow-rooted crop at the same time.

Once the salts are removed to a sufficient extent, one or two years may be required to bring the soil to its original condition of fertility. The water-logged condition and also the presence of alkali operate to destroy the bacterial activities upon which the formation of plant food depends, and time and tillage are required to restore them.

b. Plowing.—Where soil containing only a moderate amount of alkali has, through bad tillage, had this accumulated at the surface to an injurious extent, advantage may be derived from deep plowing, so as to bring fresh soil without excessive alkali to the surface for the roots of the young plants, which will be more vigorous and resistant by the time the roots reach the alkali that has been turned under.

c. Growth of Suitable Plants.—Another practice from which benefit may be obtained where the excess of alkali is not great is to plant crops that are tolerant of alkali and consume or absorb a considerable amount of it, and by repeated cropping gradually remove excess alkali from the root zone. One of the most effective plants which can be grown on slightly alkaline soil is alfalfa, which when once established brings to bear the action of deep roots and dense shade, and thus by repression of surface evaporation tends to restore the soil to its natural condition. Where mulching is practiced it is desirable to grow hoed crops, such as beans, beets, potatoes, corn, onions, and canaigre, choosing preferably the deeper-rooted of these.

Experiments recently conducted by Mr. M. E. Jaffa indicate that Australian salt-bush is likely to prove one of the most desirable forage plants for growth on alkali soils. It is readily eaten by stock, is nutritious, and has been successfully grown on alkaline land which will produce no other crop. This plant is remarkable for its productiveness and its drouth-resisting power. It is prostrate in its growth, covering the ground with a green cushion 8 to 10 inches thick, and thus effectually shading it. It is perennial, and when cut soon reproduces itself from the same root. Its yield per acre is very large, being about the same as that of alfalfa.

d. Mulching.—An excellent preventive against evaporation from the soil surface and the consequent rise of alkali is “mulching.” A good mulch is a well and deep-tilled surface soil, which is kept so constantly stirred that a crust is never allowed to form. As a result evaporation is reduced to a minimum, and the alkali remains distributed throughout the whole of the tilled layer instead of as a hard crust at the surface where the bulk of the damage is done. Large quantities of straw produces also an effective mulch, since the straw keeps the surface moist and enables the grain to germinate. The depth or thickness of this protective layer is of the utmost importance for thereby the surface evaporation is diminished. After a proper plowing to a depth of, say, 10 to 12 inches, it requires a long time for the salts to come to the surface again in sufficient amount to injure the crop.

e. Gypsum.—Where the alkali is mainly carbonate of soda, much benefit may be derived by the application of ground gypsum or sulphate of calcium. This must be thoroughly mixed with the soil, and the two salts mingling in solution in the same water, in obedience to an elementary chemical principle, perform the following reaction:

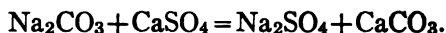

Forming Sodium Sulphate and Calcium Carbonate. The latter is only slightly soluble in water, and is harmless. The sodium is transformed into sulphate which is far less harmful than the carbonate, and is more easily removed by drainage.

Experiments have been made by Prof. E. W. Hilgard which prove the value of gypsum in neutralizing the “black alkali,” or carbonate of soda. In the case of this alkali mulching, deep tillage, suitable plant-growth, or any other corrective except gypsum is practically unavailing. Little benefit is to be expected from gypsum in the case of “white” or neutral alkali, which does little harm, however, under proper tillage; but a soil heavily tainted with black alkali can be rendered productive by the use of a ton of gypsum per acre. This is more effective when applied at the rate of about 500 pounds per acre per

annum in connection with some seeding at the same time, for the slightest growth aids in shading the ground and preventing an injurious release of salts by evaporation. Gypsum, however, cannot be used on alkali without water; its action must be continued for several months and through two or three seasons; it takes, moreover, several weeks before immunity is secured, and therefore the dressing of gypsum should be applied in ample time before the seeding; and thereafter the soil must be well cultivated the gypsum plowed in, and water promptly applied.

The sovereign preventive and cure for alkali of any kind, however caused, is deep drainage, supplemented if necessary by copious surface irrigation, to produce a downward movement of water from the surface to the drain.

Where alkali is accumulated at or near the surface, efforts are sometimes made to remove it by heavy applications of water, drained off by surface drains. Such efforts seldom yield perceptible benefit, as the water that actually comes in contact with the salt, enters the soil and remains there or passes downward, while that which runs off the surface carries very little salt.

REFERENCES FOR CHAPTER II

- BARK, DON H. Duty of Water Investigation in Idaho. 8th and 9th Biennial Reports, State Engineer of Idaho, Boise, Ida., 1910-12.
- KING, F. H. Irrigation and Drainage. Macmillan Company, New York.
- ETCHEVERRY, B. A. Use of Irrigation Water. McGraw-Hill Book Company, New York.
- HILGARD, E. W. Soils. Macmillan Company, New York.
- LYON & FIPPIN. Soils. Macmillan Company, New York
- WIDTSON, J. A. Principles of Irrigation Practice. Macmillan Company, New York.
- LOUGHRIDGE, R. H. Distribution of Water in the Soil in Furrow Irrigation. Office of Experiment Stations, Bulletin No. 203.

CHAPTER III

SOIL MOISTURE

Most soils in humid regions, and many in arid regions especially where irrigated, are permanently saturated with water at certain depths, and the surface of the saturated mass is called the "water table" or the surface of "ground water."

1. **Free Water.**—When a soil saturated with water is provided with perfect drainage, a portion of the water will be drawn off by the action of gravity, and replaced by air. This water may be called "Free Water," or "Gravity Water."

2. **Capillary Water.**—The soil thus drained will still remain moist, a considerable quantity of water being held by capillary attraction in the finer pore spaces, and as films on the particles of the soil. This is called "capillary" water; and varies in percentage with the fineness of the soil, being more abundant in clay and loam than in sandy soils. The space vacated by the gravity water is at once occupied by air, so that with the gravity water withdrawn and the capillary water remaining the soil is well supplied with both air and water, which is a favorable condition for the growth of ordinary plants. The capillary water is gradually taken up by plants or evaporated, and unless a new supply is furnished, the soil becomes what we call "dry," and the plants wilt and die for lack of moisture.

3. **Hygroscopic Water.**—After the soil has been as thoroughly dried as possible without the application of artificial heat, it still retains some water, called "hygroscopic water" that may be driven off by a protracted application of heat, after which the soil, when exposed to a moist atmosphere, will reabsorb an equal quantity of water and still appear dry, and in fact actually be dry so far as plant needs are concerned. The hygroscopic moisture in soils varies with its texture, from 1

per cent in coarse sand to nearly 10 per cent in clay, and still more when certain salts are present. It is not available for plant consumption and is properly disregarded in considering irrigation needs. The soil must receive an appreciable addition of water usually over 50 per cent above its content of hygroscopic water, before any becomes practically available for plant use, and every addition above this point makes it more and more easily available; that is, it is more loosely held by the soil particle, until a plenitude of moisture is reached called the "maximum capillary capacity," after which additional water flows off the soil particles under the action of gravity and drops to lower levels or drier soil, or passes down to the water table, as gravity water.

The capacity for holding capillary water varies with the density of the soil, from about 12 per cent for coarse sand to 20 per cent for very heavy clay, averaging about 16 per cent for loam.

The amount of capillary water held by the soil particle before it becomes practically available for plant consumption must exceed 1 per cent for coarse sand, 2 per cent for fine sand, 3 per cent for sandy loam and 4 per cent and over, for heavier loams and clay. Even at these percentages, the water is taken by plants slowly and with difficulty, and a larger quantity is necessary for the best growing conditions. When the amount of capillary water falls below these quantities, the plant begins to show signs of distress, growth ceases, wilting begins, and permanent injury or death will soon ensue unless water is supplied. The point at which wilting begins in any given soil is called the wilting coefficient of that soil. It is nearly the same for all ordinary crops.

4. Capillary Movement.—Capillary water moves in any direction toward drier soil under the action of capillary attraction. At the water table all the pore spaces of the soil are filled with water. Just above this level, the soil is wet to its "capillary capacity," and the remainder of its pore spaces are filled with air. The amount of capillary water held by the soil diminishes from the water table upward at a rate uniform for uniform soil

texture, and approximates zero at a distance above the water table, depending upon the fineness of the soil particles, and varying from about 1 foot for coarse sand, to 6 feet or over for heavy clay. Its motion is extremely slow in clay, and relatively rapid in coarse-grained soils.

Lyon and Fippin have given the rate and extent of capillary movement for the various soils shown in the following table:

TABLE II.—EXTENT AND RATE OF CAPILLARITY

Kind of Soil	CAPILLARY RISE IN INCHES							
	15 min.	1 hr.	2 hrs.	1 day	3 days	8 days	13 days	19 days
Silt and very fine sand..	2.7	4.7	7.0	20.0	30.0	45.0	52.0	56.0
Very fine sand.....	7.6	10.0	12.4	21.0	23.0	26.0	27.5	28.5
Fine sand	9.0	9.5	10.0	11.6	13.0	14.3	15.2	16.0
Coarse and medium sand	5.8	6.0	6.3	7.5	9.0	10.0	11.5	12.5
Fine Gravel	4.0	5.0	5.3	6.4	8.0	9.0	10.0	10.8

Clay will give a greater total rise but at a slower rate than any of the above results. Instances have been recorded where water has risen by capillarity a total distance of 8 feet through heavy clay.

Where water is applied in irrigation, the soil in proximity to the water is, of course, immediately saturated, and the gravity portion of the water seeks lower levels, under the influence of both gravity and capillary attraction. This movement is rapid in coarse open soils like sand or gravel, but much slower in loam or clay. The wetted soil retains a sufficient quantity to satisfy its capillary capacity, and all the surplus continues to sink, filling the soil to the capillary capacity as it goes until ground water is reached, when the surplus is consumed in raising the ground-water table or passes away in whatever drainage channels are available.

5. Optimum Water Supply.—The ideal quantity of water for most rapid plant growth is that quantity that will just fill the soil to its capillary capacity to the depth occupied or soon to be reached by plant roots, without affording any excess to

escape to the ground water table, or to the soil zone below the reach of crop roots. All water that escapes to the water table and passes off as drainage is usually wasted, carries with it in solution more or less plant food, and may contribute to raise the water table and produce seepage troubles. For these reasons it is usually better to stop short of the complete capillary saturation of the soil in the root zone than to risk the loss of water, by excess application. It is generally not possible to attain the ideal, for if the soil be charged to its capillary capacity to the bottom of the root zone, and the water table be not reached, the water will continue to descend under the combined action of gravity and capillarity, and thus escape beyond the reach of crop roots and leave the soil in the root zone with less than its full load of capillary water.

At the end of each irrigation, the upper zone of the soil is saturated to a considerable depth, and the gravity water in this zone is slowly descending to lower levels. Evaporation from the surface begins almost immediately, and the moisture of the surface soil is soon reduced by the combined process to a point below capillary saturation, and shortly after, an upward movement begins of capillary water to supply the losses from evaporation from the surface. The zone of saturation is thus slowly sinking in obedience to the force of gravity, and is also being depleted by capillary action both upward and downward, and unless an excess has been applied, the store of free or gravity water is soon dissipated and distributed through the soil as capillary water. Thus, after each irrigation, a condition is soon reached, in which a narrow zone a short distance below the surface is in a state of capillary saturation, and the percentage of moisture diminishes both upward and downward, at a nearly uniform rate. If at this time the moisture at the lower limit of the root zone is just a little above the wilting coefficient, the water has been economically applied, and none wasted. The water content of the soil decreases gradually from this point by evaporation from the surface, and by plant consumption and transpiration throughout the zone occupied by plant roots.

As the evaporation all occurs from the surface, the general movement of moisture is upward soon after the supply of gravity water is dissipated. The tendency therefore is to accumulate the soluble portions of the soil at or near the surface, where the pure water is evaporated and the solids are left behind. It is important that this tendency be combated by retarding evaporation through cultivation. When crops are not cultivated, the evaporation from the surface may be nearly as great as the consumption of moisture by the plants, whereas if the soil is kept pulverized to a considerable depth, the volume of water taken up by the plants is 5 or 6 times as great as that lost by evaporation, which hence becomes almost negligible, and has little tendency to accumulate salts at the surface, and this is overcome by necessary deep plowing.

Soil which is as dry as it can be made without artificial processes still contains a considerable amount of hygroscopic moisture adhering to its grain. The percentage by weight which this bears to the weight of the soil is called the hygroscopic coefficient, and this must be increased at least 50 per cent before it becomes available for sustaining plant life.

6. Wilting Coefficient.—The point at which vegetation wilts and dies for lack of moisture is called the wilting coefficient. The water available for plant consumption, therefore, is that portion of the capillary water which it contains in excess of the wilting coefficient. The water content of the soil upon which a growing crop depends must never fall as low as the wilting coefficient, nor be increased above the capillary capacity, except temporarily.

7. Water Required.—The amount of water required for a single irrigation depends on the character of the soil, the depth to which it is desired to moisten it, and the amount of moisture it already contains.

Prof. L. J. Briggs, Prof. Loughridge, Prof. Hilgard and others have made a large number of observations upon the hygroscopic and wilting coefficients of various soils, and a large number of comparisons of these are condensed in the following table, which gives also the capillary capacity, the available

capacity or difference between the capillary capacity and wilting point, and the total capacity for moisture for various soils:

TABLE III.—PERCENTAGE BY WEIGHT OF MOISTURE CAPACITIES FOR VARIOUS SOILS

Type of Soil	Hygroscopic Coefficient	Wilting Coefficient	Capillary Capacity	Available Capacity	Total Capacity
Coarse sand	1.0	1.5	13	11.5	33
Fine sand	2.1	3.3	14	10.7	34
Sandy loam	4.7	7.0	15	8.0	35
Fine sandy loam	6.9	10.8	16	5.2	37
Loam	9.1	13.4	18	4.6	38
Clay loam	11.8	15.0	19	4.0	40
Clay	13.2	16.5	20	3.5	42

It will be seen from the above that if a loam of the type above assumed is dried to the wilting point, it still contains 13.4 per cent of water by weight, and can retain by capillarity 4.6 per cent additional water, or about 4 pounds per cubic foot, and it would require about $\frac{1}{4}$ cubic foot of water to fill a square foot of area to a depth of 4.2 feet to its full capillary capacity. Such an application to very dry loam of the type assumed would constitute a good irrigation. That is it would require 3 inches in depth applied to the land.

Similarly, a sandy loam of the type given in the table would require under the same circumstances about 75 per cent more water, or a depth of about $5\frac{1}{4}$ inches; coarse sand would require about $7\frac{1}{2}$ inches in depth, and clay would require a little less than 3 inches.

Irrigation should always be applied before the soil moisture reaches the wilting point throughout the root zone, otherwise the plants will be severely injured or killed.

CHAPTER IV

PLANT FOOD

THE essential mineral elements of plant food derived from the soil are calcium, potassium, phosphorus, magnesium, iron and sulphur. Other elements, equally important, are derived mainly from air, and water, or from decayed vegetation. These are nitrogen, oxygen, hydrogen and carbon. Magnesium, iron and sulphur are used in very small amounts, and occur in all natural soils in sufficient quantity to answer ordinary plant needs, but most soils require for best results the occasional artificial addition of some of the other elements. Nearly all the hydrogen, and most of the oxygen consumed by plants is furnished in the form of water (H_2O).

1. Functions of Water in Plant Growth.—Water is the most abundant constituent of the body of the live plant, and thus forms a most important element of the plant's food. In addition to this, it is the necessary vehicle for carrying in solution all the other elements of plant food that are absorbed from the soil by plant roots, and conveyed in solution to the various parts of the plant for assimilation. Hence the vital importance to the plant of having a constant and sufficient supply of water. When the water has performed its function as a vehicle the portion not required for food by the plant is transpired by the leaves, and absorbed by the atmosphere in the form of watery vapor.

The amount of water consumed by the plant in forming a unit quantity of tissue varies widely with the character of the plant and the available plant food. The results of experiments to determine this are found in the following table:

TABLE IV.—POUNDS OF WATER CONSUMED BY VARIOUS CROPS IN THE PRODUCTION OF ONE POUND OF DRY MATTER

	Lawes and Gilbert	Hellreigel	Wollny	King	Widtsøe	Average
Wheat.....	225	359	1006	530
Oats.....	...	402	665	557	...	541
Barley.....	262	310	774	393	...	435
Peas.....	235	292	479	447	...	363
Red Clover.....	249	330	...	453	...	344
Corn.....	233	272	387	297
Potatoes.....	423	1440	931
Beans.....	214	262	238
Buckwheat.....	...	371	664	518
Sugar Beets.....	662	662
Alfalfa.....	970	970
Average.....	530

2. **Mineral Foods.**—Since the plant can take its food only in liquid form it follows that soil particles to be available for plant food must be soluble in water. All the chemical elements are to some extent soluble in water, but they differ widely in the rapidity of solution, and the amount that can be dissolved by a given quantity of water.

All nitrates and most combinations of sodium and potassium are readily soluble in water in considerable quantities, but even these are strictly limited in the amount that can be dissolved in a given volume of water, which is said to be "saturated" when it can dissolve no more of a given solid. When such a saturation solution is subjected to evaporation, the water passes into the atmosphere, and leaves a portion of the dissolved mineral in excess of that which the remaining water can hold in solution, which is accordingly deposited as solid crystals of the mineral with which the water is saturated. At the same time other minerals may be present in quantities below the point of saturation, and these may remain in solution.

In general, nitrates dissolve in water rapidly and in considerable quantities. Sulphates, phosphates and carbonates are soluble in less degree, and silicates still less so, except the

alkaline salts, most of which are readily soluble. Nitrogen is a rather inert element, having little chemical affinity for any other elements. Hence in nature it exists almost entirely as a free gas in the atmosphere, uncombined with any element. Pure air is composed of a mechanical mixture of oxygen and nitrogen uncombined chemically, in the proportion of 4 parts of nitrogen to 1 of oxygen by weight. The oxygen is vitally necessary to animal existence, while the free nitrogen, though harmless, is unnecessary except as a dilutant. This inert nitrogen, however, when combined with other elements, forms some of the most useful and necessary foods, both plant and animal, and in still other combinations forms some of the most powerful acids and explosives. It has a constant tendency to revert back to its atmospheric state, and hence the stores of natural combined nitrogen are rare and limited. Their proportion of the solid earth is negligible, and the existing stores of nitrates are valuable as fertilizers and for other uses.

When natural rocks are disintegrated and broken up into fragments and soil particles, the more soluble portions are gradually dissolved by the rains and pass off with the drainage water. It thus occurs that the more soluble salts of sodium and potassium are carried to the ocean and held there in solution in large quantities, while the silicates and other relatively insoluble rock particles remain as soil. The sulphates, phosphates and carbonates of the non-alkaline metals being less soluble than the alkaline salts, pass away less rapidly, but being more soluble than the silicates of the same metals, have a constant tendency to leach out and leave the silica and silicates in the form of sand and clay to form the main constituents of the soil. The tendency is thus in humid regions except in swamps, gradually to deprive the natural soils of their mineral plant food, a tendency existing in far less degree in arid regions. Hence the soils of arid regions are much richer in mineral plant food than most of those in humid regions, but the latter are generally better supplied with nitrates, contained in humus or vegetable mold.

3. Fertilizing Effects of Sediments.—The value of silt-bearing water as a fertilizer is well known. In the valley of the Moselle, France, on land barren without fertilization, the alluvial matter deposited by irrigation from turbid water renders the soil capable of producing two crops a year. In the valley of the Durance, France, the turbid waters of that stream bring a price for irrigation several times greater than that paid for the clear cold water of the Sorgues River. It has been estimated that on the line of the Calloway canal in California, land which has been irrigated with the muddy river water, gives 18 per cent better results after the fifth year than the same land which has been irrigated with clear artesian water.

In the Nile Valley the turbid waters of the White Nile are recognized as far more valuable than the clear waters of the Blue Nile, on account of the fertility carried by the mud.

The fertilizing value of the silts of some of our southwestern streams is shown by the following table, which compares their fertilizing contents with the food requirements of a ton of alfalfa:

TABLE V.—FERTILIZING VALUE OF SEDIMENT

River	Date	PLANT FOOD PER ACRE FOOT OF WATER			Authority
		Phosphoric Acid lbs.	Potash lbs.	Nitrogen lbs.	
Rio Grande	1893-94	31.4	325.5	24.40	Goss
Salt River	1899-1900	10.5	26.5	9.00	Forbes
Colorado, minimum.....	1900-1901	2.26	16.3	1.03	Forbes
Colorado, maximum.....	1900-1901	43.56	444.6	69.70	Forbes
1 ton alfalfa	16.7	33.0	42.00	Goss

REFERENCES FOR CHAPTERS III AND IV

- BRIGGS, L. J. and SCHANTZ, H. L. Wilting Coefficient for Different Plants. Bulletin No. 230. Bureau of Plant Industry, Washington.
- WIDTSON, J. A. Storage of Winter Precipitation in Soils. Utah Exp. Sta., Bulletin No. 104.
- ETCHEVERRY, B. A. Use of Irrigation Water. McGraw-Hill Book Company New York.

- FORTIER, SAMUEL. Evaporation Losses in Irrigation and Water Requirements of Crops. Bulletin No. 177. Office of Experiment Stations, Washington.
- LOUGHRIDGE, R. H. Moisture in California Soils. Report of Agricultural Experiment Station, University of California, 1897-98.
- WIDTSOE, J. A. and McLAUGHLIN, W. W. Movement of Water in Irrigated Soils. Utah Experiment Station. Bulletin No. 115.
- LYON & FIPPIN. Soils. Macmillan Company, New York.
- BARK, DON H. Alfalfa Growing. Address before Western Canada Irrigation Association. Bassano, Alberta, November, 1915.
- GOSS, ARTHUR. Principles of Water Analysis as Applied to New Mexico Waters. Bulletin No. 34. New Mexico Agr. Exp. Station.
- FORBES, R. H. The River Irrigating Waters of Arizona. Bulletin No. 44. University of Arizona Agricultural Exp. Station, Tucson, Arizona.
- FOLLETT, W. W. Silt in the Rio Grande. International Boundary Commission, Dept. of State.
- SWINGLE, Z. T. Bulletin No. 53. Bureau of Plant Industry.
- HILGARD, E. W. Distribution of Salts in Alkali Soils. Bulletin No. 108. Univ. of Cal.
- WILSON, H. M. Irrigation in India. Part II of 12th Annual Report, U. S. Geological Survey.
- ETCHEVERRY, B. A. Irrigation Practice and Engineering. McGraw-Hill Book Company, N. Y.

CHAPTER V

WATER SUPPLY

ALL the water used by plants is precipitated from the atmosphere as rain, snow or dew, which in humid regions are sufficiently regular and abundant for crop production, but in arid regions are sufficient only for the precarious sustenance of a limited variety of grasses, shrubs and trees which have the property of becoming dormant without dying in times of drouth, and reviving and growing when sufficient moisture comes.

The groups and ranges of mountains in arid regions by reason of their superior elevation have greater precipitation than the plains and valleys, and thus become the sources of such streams as occur, and the snows of winter falling on those mountains serve as storage reservoirs, to hold the moisture until the warm days of spring and summer melt the snow and swell the streams at the time their waters are needed for irrigation upon the valleys which they traverse. These streams constitute the principal source of water used in irrigation.

1. Causes of Rainfall.—Although meteorology is a rather elusive science, much progress has been made in the study of phenomena and some general laws regarding the cause and distribution of rainfall have been evolved.

The capacity of air for holding water in the form of an invisible gas is a function of its temperature. Warm air can retain a large amount of moisture without any tendency of the moisture to condense; but if the air be cooled sufficiently a point will be reached where the water begins to condense, and separate as particles of vapor or cloud. At this point the air is said to be saturated, and the relative humidity is 100 per cent. This critical temperature is called the dew point. The particles of vapor are very minute, and they may float about

as clouds, but if formed rapidly they usually coalesce into large drops and fall as rain.

The principal causes that contribute to abundant rainfall are:

1. Proximity to the ocean or other large body of water.
2. Mountain ranges, especially if their trend is at right angles to the direction of moisture-laden winds.
3. Location on or near the track of cyclonic storms.

The North Pacific Coast combines all three tendencies, resulting in a heavy precipitation.

The first condition is not always sufficient, as many islands in the Pacific Ocean are arid, as is the Pacific Coast of Southern California, Mexico and parts of South America.

The greatest rainfall usually occurs in belts where moist winds from large bodies of water are forced to rise and pass over mountains which forcibly cool them and condense their moisture. Such conditions are most pronounced where a high mountain range parallels an adjacent sea coast and is at right angles to the direction of the prevailing winds. As the water-laden air rises, the overlying atmosphere becomes less, thus decreasing pressure, and allowing the elastic air to expand, which in turn causes rapid cooling, condensation and precipitation of the moisture. If the mountain range is high and extensive, the process is proportionately complete, and as the winds descend the leeward slope and are again compressed their moisture-absorbing qualities increase and they produce arid conditions unless the process is repeated by passage over a still higher range. This process is well illustrated on our own Pacific Coast, where the moist winds from the great ocean are intercepted by the Coast Range, and a large part of their moisture thereby precipitated. They pass over the Central Valley which is thus left with less than half the quantity of rainfall that falls on the Coast Range. Further inland the winds ascend the high Sierras and leave on their summits about as much moisture as precipitated on the Coast Range. Thus depleted the winds again descend to the plains of the Interior, as an

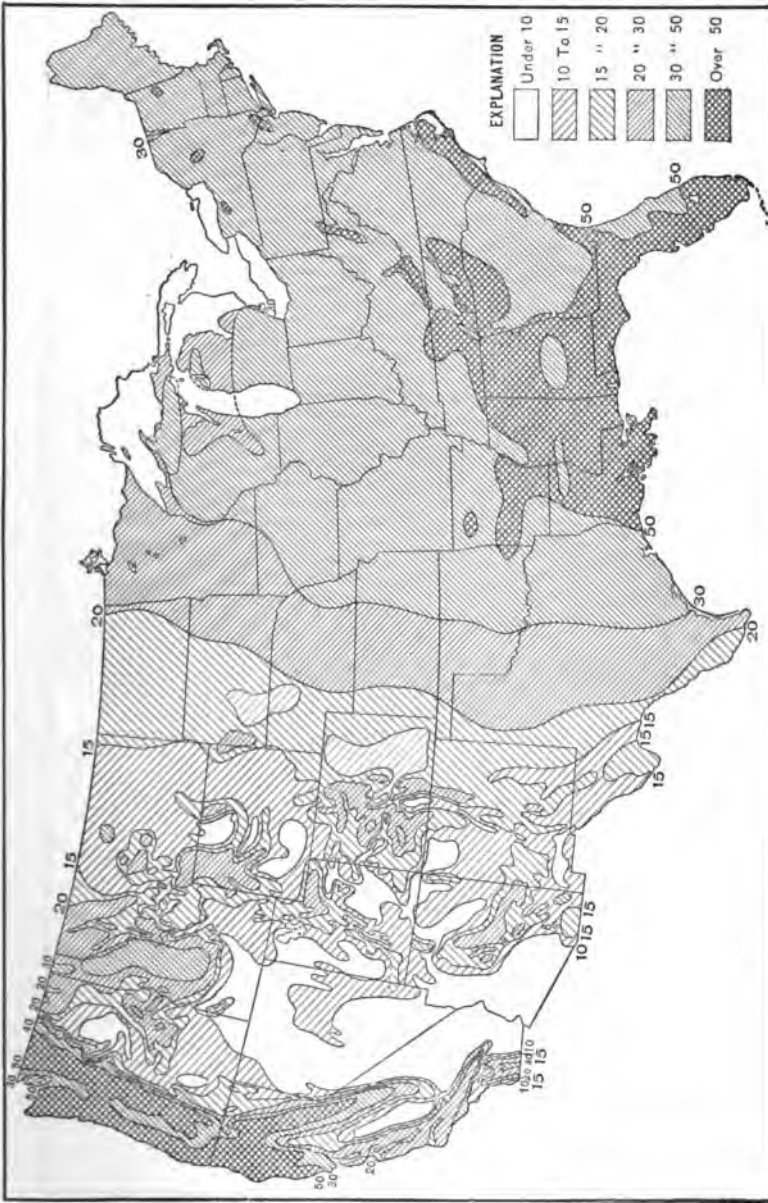

FIG. 1.—Mean Annual Precipitation in the United States.

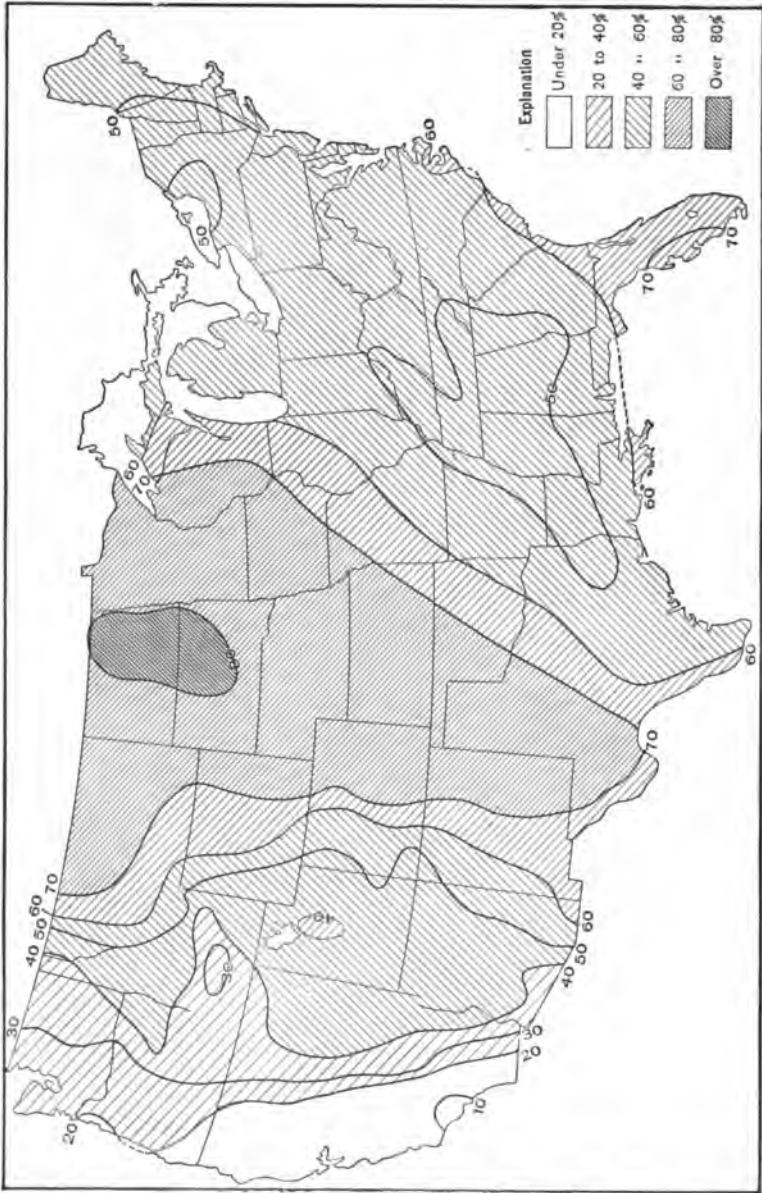

Fig. 2.—Percentage of Annual Precipitation Occurring between April 1 and September 30.

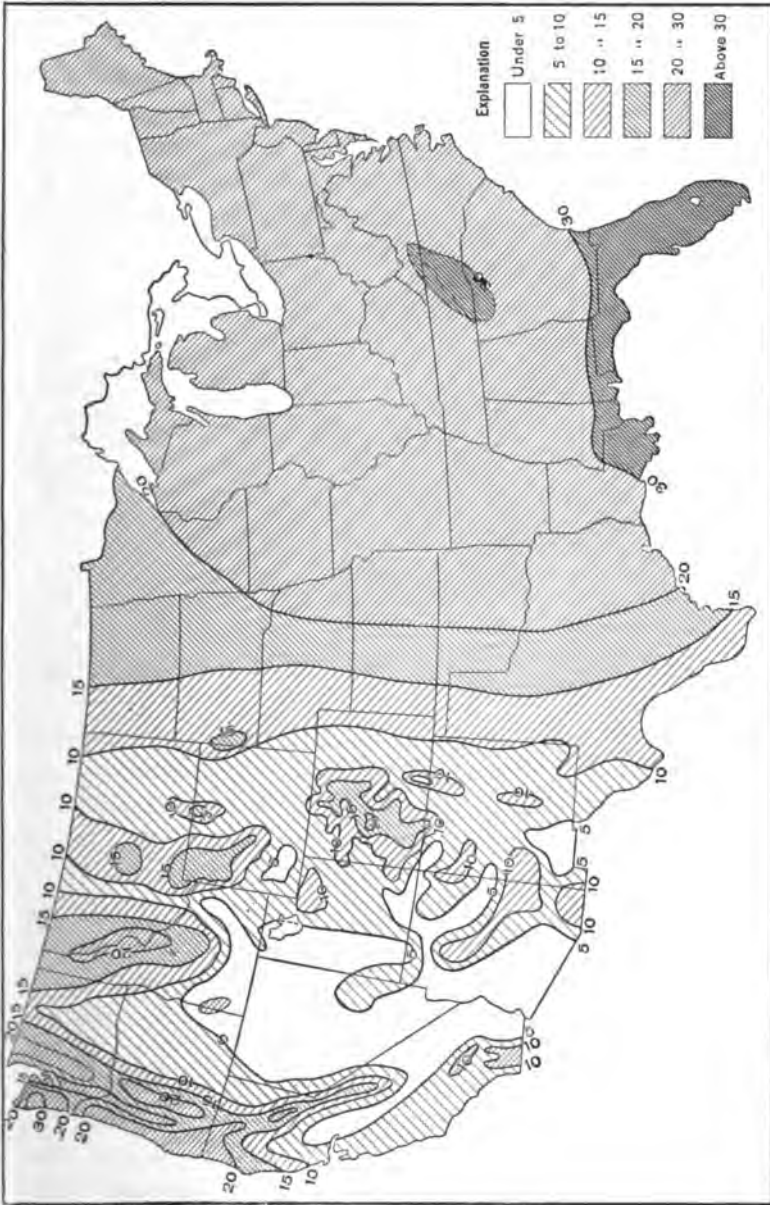

FIG. 3.—Mean Precipitation Occurring between April 1 and September 30.

arid atmosphere, and the region is much drier than similar altitudes west of the mountains.

Whatever the direction of the winds the general law of condensation, due to dynamic cooling, usually causes an increase of precipitation with increase of altitude provided all other conditions are similar. The following table from Prof. D. W. Mead illustrates this law as manifested in the Vogesen Mountains and also shows the erratic variations:

TABLE VI.—RAINFALL IN THE VOGESSEN MOUNTAINS

Station	Altitude, Feet	Rainfall, Inches	Increase per 100 ft. Altitudes
Seunheim.....	900	32.28
Thann.....	1100	38.19	3 inches
Weller.....	1260	55.90	11 "
St. Amarin.....	1320	59.06	5.2 "
Wessering.....	1400	64.18	6 "
Odern.....	1510	75.98	10 "
Wildenstein.....	1870	99.21	6 "
		Mean	6.9 inches

This rule, however, must be accepted with great caution, as there are numerous exceptions hard to explain, besides the manifold differences traceable to topographic conditions.

2. Types of Rainfall.—On the Pacific Coast of North America the precipitation is greatest in winter and least in summer, there being little or no rain from May to September. This rule is reversed on the Great Plains, where June is the month of greatest rainfall. A modification of the latter type prevails in Arizona and New Mexico, where the greatest rainfall is in July and August.

Pacific Type.—On the Pacific Slope there is a distinct division into the wet and dry seasons, the wet season being the winter and the dry the summer. In the northern part of this belt, on the coast of Washington, Oregon and Northern California, the wet season is long and the precipitation heavy, averaging 70 inches or more per annum, and the dry season

though shorter, is nearly or quite rainless. Passing southward the precipitation becomes gradually less, the rainy season shorter and the dry season longer, until at the Southern boundary of

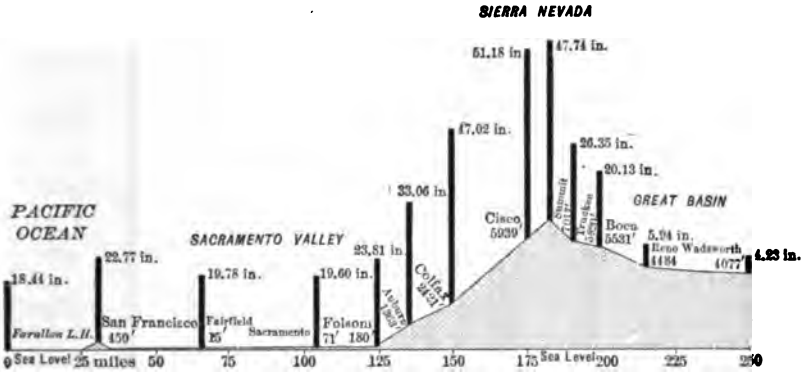

FIG. 4.—Diagram Showing Effect of Topography on Rainfall in California and Nevada. After Hamlin.

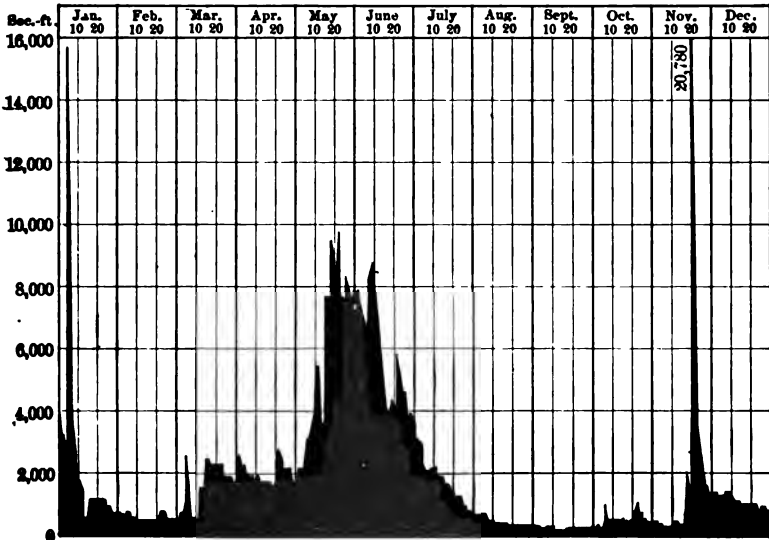

FIG. 5.—Discharge of San Joaquin River at Herndon, California, 1900.

California the annual precipitation averages less than 10 inches, and the climate is distinctly arid, while still retaining the type form of long dry summers, and short and relatively wet winters.

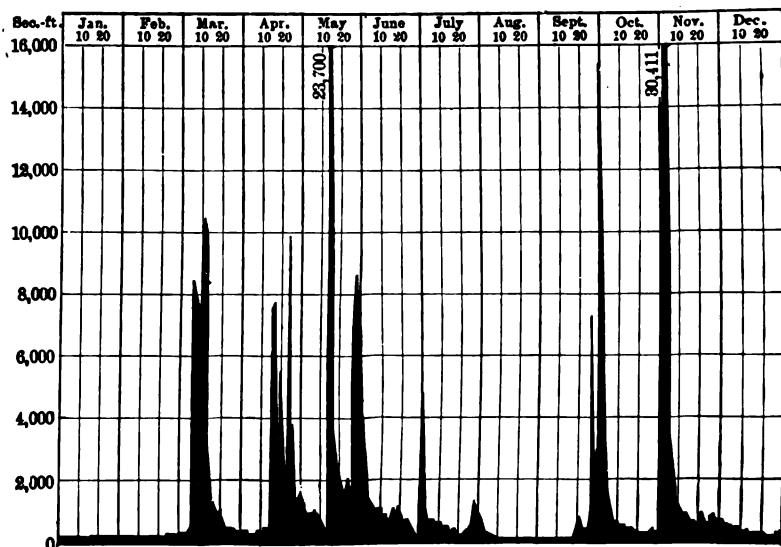

FIG. 6.—Discharge of Neosho River near Iola, Kansas, 1900.

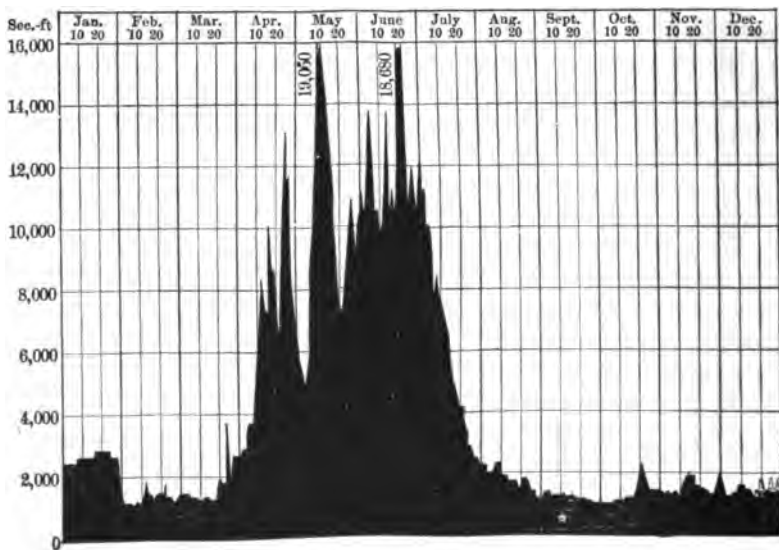

FIG. 7.—Discharge of Boise River at Boise, Idaho, 1899.

Rocky Mountain Type.—A contrasted type of precipitation is less distinctly marked, but prevails with some variations over most of the arid region east of the Cascade and Sierra Nevada Mountain Ranges. Those mountains intercept the

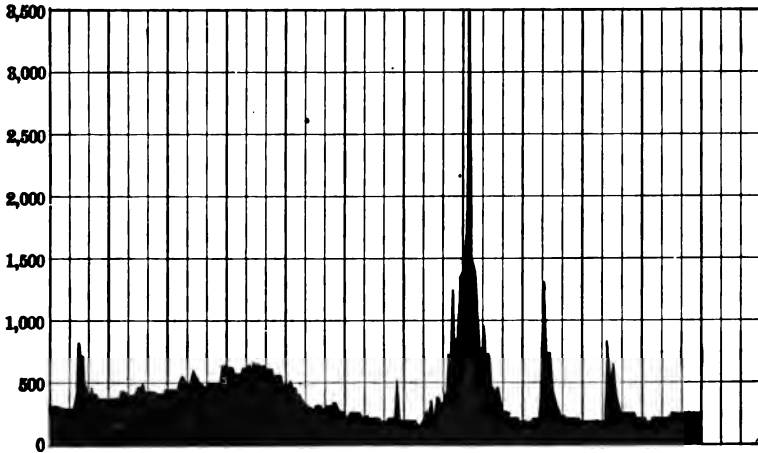

FIG. 8.—Discharge of Salt River at McDowell, Arizona, 1899.

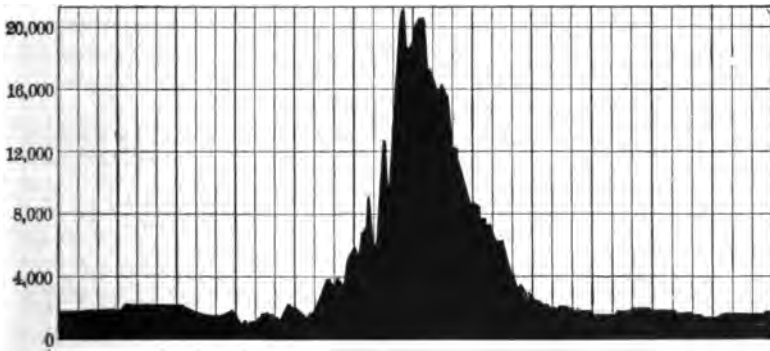

FIG. 9.—Discharge of Green River at Green River, Wyoming, 1899.

waterladen winds from the Pacific Ocean, and rob them of most of their moisture during the winter when the temperature is low enough to condense the vapors, but in late summer, those winds pass over the heated valleys and mountain ranges and carry their moisture further eastward, where the meteoric

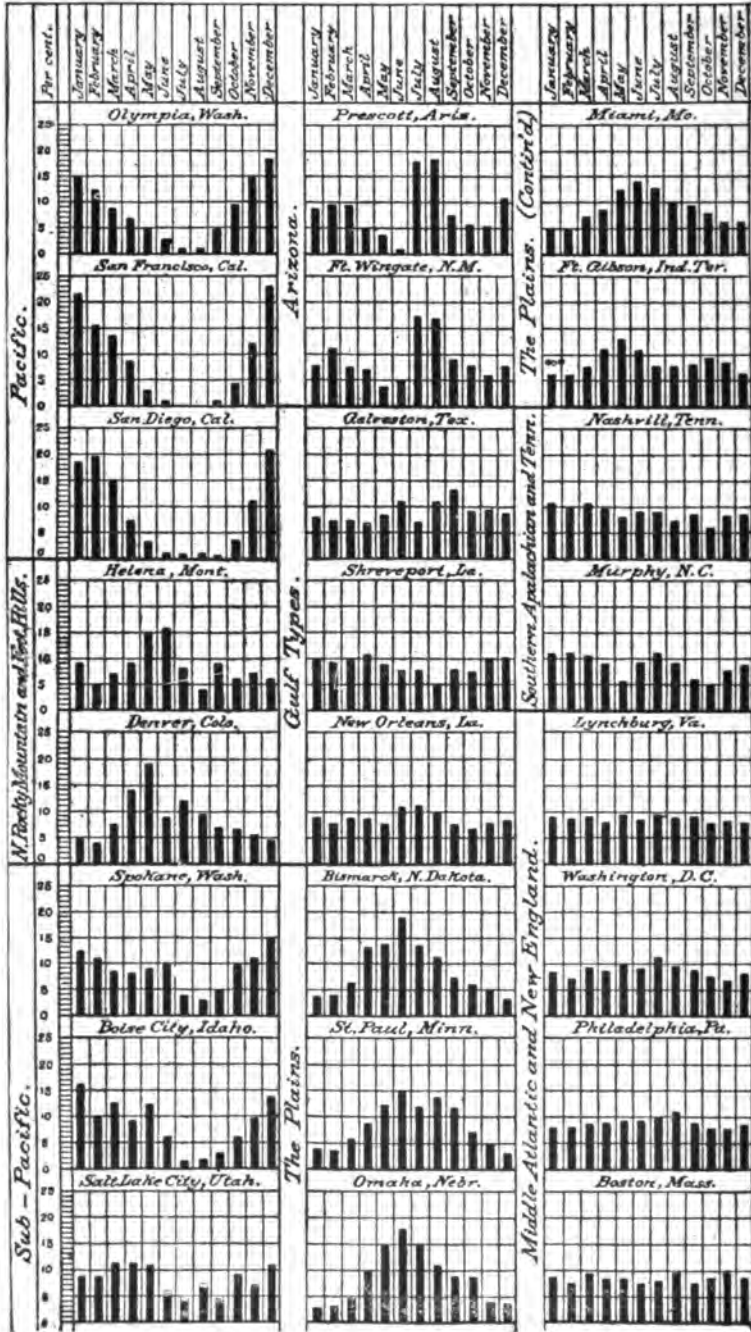

FIG. 10.—Types of Monthly Distribution of Precipitation in the United States. After A. J. Henry.

fluctuations cause many local showers and thunder storms, and produce a pseudo-rainy season in the Rocky Mountain Region in the months of May and June, while the winters are drier than those of the Sierra Nevada Range. The precipitation in winter usually occurs in the form of snow except in the plains and valleys of the south and near the Pacific Coast, where winter rains occur. The diagram, Fig. 10, after Prof. A. J. Henry, shows several types of western rainfall, contrasted with various eastern types.

In general the heaviest precipitation is in the mountains, which in winter is mainly in the form of snow. Notable exceptions occur, however, and give rise to contrasting types of stream flow.

3. Stream Flow.—Where the streams are mainly fed by snow, they have a comparatively regular habit. The first warm days of spring melt the snow on the plains, and the advancing season melts first the snow in the foothills and on sunny mountain slopes, and as summer heat increases the melting increases in rapidity and extends to higher altitudes and to more shady slopes. Thus the streams begin to rise in early spring about the time of seeding in the lower valleys, and continue to rise as heat increases, culminating usually in June on most American streams, declining as the reserve of snow diminishes, and reaching extreme low water in autumn or winter.

This process has temporary variations due to occasional showers of rain, and to variations of temperature affecting the melting of snow, which is accelerated by bright warm weather, and checked by cloudy days. There is also a wide variation in the snowfall from year to year, profoundly affecting the water supply. A year of scanty snowfall not only furnishes a scanty supply of water, but the shortage is likely to be concentrated at the latter end of the flood season. That is, a scanty snowfall may furnish nearly as much water early in the season as a year of abundance, but the small quantity of snow is sooner exhausted, and the low-water stage arrives earlier in the season.

Where snowfall plays a small part or no part at all in the flow of streams, which are mainly supplied by rains as some of

the small streams of the south and southwest, the regimen of the streams is far less regular than that of those dependent on melting snow. Such streams constitute a second type having a wide variety of characteristics and far less susceptible of approximate prediction. The runoff fluctuates more, and is characterized by high and low periods succeeding one another in quick succession. For these reasons, a much larger storage capacity in proportion to the total normal water supply is required on such streams than on streams of the first type.

Streams of the first class, which depend upon melting snows for their main supply, vary in habit, but to a less degree than others. In general, since the flood season occurs entirely in the season of irrigation, it is very favorable to agricultural use, and a large proportion can be thus utilized without artificial regulation. Examination of a large number of instances shows the availability of from 40 to 60 per cent of the total supply in normal years without storage, and that the full supply can be utilized by a capacity for storage of about 40 to 60 per cent of the total volume. This storage would be supplied from the winter flow, and from the excess supply during the flood season, usually May and June.

In planning the full utilization of a water supply, the close study of stream flow records necessary will show that there is a large variation in the total supply from year to year, in the low-water discharge, and also in the maximum flood wave that must be reckoned with. Moreover, these quantities bear only a very casual and uncertain relation to each other. For these reasons, it is important that as long a record of stream flow as possible be secured before final determination is made of the possibilities of irrigation.

It will generally be found that the extreme low-water periods and the extreme flood waves occur only at long intervals, and it is usually unwise to limit development to the extent of furnishing a full normal supply to the lands served in the rare years of extreme low water, but rather to provide a full supply during most years, and in the exceptional years of low water, occurring only at long intervals, be content with 60 or 70 per

cent of a full supply for a brief period. By more careful use and better cultivation results can be obtained which will approximate the normal, while the total development from the stream will be much greater than if such limits were not allowed.

Where an enterprise depends largely on a stored water supply, a threatened shortage is foreshadowed by a shortage in the reservoir, and this, in conjunction with other available indications, serves as a warning of impending scarcity, and farm operations can be modified accordingly.

For this reason it is admissible to tolerate a somewhat greater shortage in low years under a stored supply than if no storage is connected with the enterprise. For the same reason, if the conditions are such that the storage to be reasonably expected comes before the beginning of the irrigation season in which it is to be used, a somewhat greater shortage can be tolerated than if dependence is placed upon the surplus of May and June, which cannot be certainly known before the various farm enterprises for the summer are well under way. But even in this case there will be 30 to 60 days notice of a shortage, which is sufficient to avoid much wasted labor, and a few fields left fallow on such occasions are not a serious loss.

In most irrigation enterprises the quantity, dependability, and manner of occurrence of the water supply is of first importance. This is sometimes obtained from wells either by pumping or by artesian flow, which are treated elsewhere. The great majority of irrigation systems obtain their supply from natural streams, supplemented in some cases by reservoirs.

The stream or streams to be used should be carefully measured at each point of diversion and at each proposed reservoir site.

Measurements of many streams of the West have been made and published by the U. S. Geological Survey, and by some of the State Engineers, but often these are lacking or must be supplemented by stations located with special reference to the plans of storage and diversion under study.

These measurements to be a safe guide must extend over

several years, the more the better, and allowance must be made for somewhat greater extremes than those shown by the records, as it is highly improbable that any existing records show the greatest extremes that ever have occurred or ever can occur. The shorter the record the greater allowance must be made for this purpose.

The misleading nature of a short record is shown by the experience with the Conconully reservoir in Northern Washington, where a record of five years indicated a minimum annual supply of 29,000 acre-feet, which was followed by seven years in which the maximum was 24,700 and in which there were two years in succession of 19,220 and 15,860 acre-feet respectively.

4. Laws of Runoff.—Where it is necessary to study the water supply of a given stream in the absence of actual measurements or with a very short record, recourse is sometimes had to formulæ for computing runoff from data regarding rainfall, evaporation, etc., which have been published from time to time. Great caution should be exercised in employing any such formulæ, as the working data for this use is generally inaccurate, and it is impossible to allow properly for the variations from the complicated conditions upon which such formulæ are based. It is necessary to especially emphasize this caution, as the formulæ or rules referred to are sometimes promulgated with a confidence that has no adequate foundation.

The runoff depends not only upon the rainfall and the drainage area, but also upon a multitude of other conditions many of which are variable, and none of which can be accurately determined within reasonable time and cost. The chief elements affecting the runoff are the following:

a. Drainage area tributary to the stream above the point of diversion. This can be determined with practical exactness wherever the topographic divide is definite.

b. The Rainfall.—This varies widely in different years, and in corresponding months of different years, and in different parts of the basin in such an erratic manner that it can be only roughly approximated in a large basin by ordinary feasible methods. It is seldom that in a new country a record suffi-

ciently detailed and reliable for use in a computation of runoff can be had.

c. The Character of Rainfall.—A slow drizzling rain is more apt to be absorbed and later to evaporate than a driving storm which runs off quickly before absorption. This factor varies with every storm, without law, and it is impossible to define the different varieties. The absorption and residual runoff also varies with different conditions of moisture in the soil. When rain falls on a dry baked surface it is not readily absorbed, and largely runs off. The same storm falling on the same surface, moderately moist, is more easily absorbed and the runoff is less. If the soil becomes saturated, however, the absorption ceases, and the rain runs off.

d. Evaporation.—This differs widely from day to day and from year to year with weather conditions, and especially with presence or absence of moisture to evaporate, and the varying relation of that moisture to the atmosphere.

e. Topography.—Steep slopes increase runoff, while gentle slopes encourage absorption and evaporation.

f. Soil.—Bare rock or clay or a covering of thin soil over rock or clay is favorable to heavy runoff, while a deep sandy soil favors absorption and subsequent evaporation. A given basin may present a great variety of soil conditions.

g. Geologic structure affects total runoff by sometimes carrying absorbed water under ground to adjacent drainage basins. This influence is sometimes very important.

h. Vegetation.—Other things being equal vegetation retards runoff and subsequent evaporation. It also transpires a large amount of water through its leaves, and this varies widely with the character and density of the vegetation, and with the weather.

The impracticability of expressing accurate mathematical relations for so many and such erratic and indeterminate factors is obvious; and the attempt to apply such relations to a different basin with different conditions borders on the absurd.

A knowledge of the area of the drainage basin from which the water supply is to be drawn, and of the rainfall at various

WATER SUPPLY

TABLE VII.—DISCHARGE OF TYPICAL STREAMS OF THE WEST

State	River and Station	Area Basin, Sq. Mi.	DISCHARGE				ANNUAL RUNOFF	
			Maximum Sec. Ft.	Minimum Sec. Ft.	Mean Sec. Ft.	Total Acre. Ft.	Mean Depth, Ins.	Per Sq. Mi. Sec. Ft.
Arizona	Salt, Granite Reef	12,260	143,200	320	3,170	2,297,000	3.50	0.26
	Gila, Florence	17,834	133,000	0	500	364,000	0.50	0.06
California	Colorado, Yuma	225,000	150,000	2,600	23,866	17,289,000	1.44	1.06
	American, Fair Oaks	1,910	105,000	100	5,526	4,000,000	39.30	2.89
	Feather, Oroville	3,640	187,000	940	8,696	6,296,000	32.37	2.39
	Sacramento, Red Bluff	10,400	254,000	3,980	15,500	11,222,000	20.25	1.49
	Tuolumne, La Grange	1,500	52,600	0	3,033	2,196,000	27.45	2.02
	San Joaquin, Herndon	1,637	21,372	60	2,464	1,784,000	20.40	1.51
	Kern, Bakersfield	2,345	9,595	80	1,110	804,000	6.39	0.47
	Kings, Sanger	1,740	22,732	145	2,705	1,959,000	21.21	1.56
	San Gabriel, Azusa	222	12,500	0	159	115,000	9.70	0.72
	Santa Ana, Mentone	182	4,998	3	980	709,000	7.32	0.54
Colorado	Arkansas, Canyon	3,060	4,750	124	814	589,000	3.67	0.27
	Rio Grande, Del Norte	1,400	14,000	69	871	632,000	8.43	0.62
	South Platte, Denver	3,840	2,425	42	422	306,000	1.44	0.11
	Cache La Poudre	1,060	5,060	32	339	245,000	4.35	0.32
	Grand, Glenwood Springs	1,520	37,200	355	3,028	2,192,000	27.06	1.99

TABLE VII—DISCHARGE OF TYPICAL STREAMS OF THE WEST—Continued

State	River and Station	Area Basin, Sq. Mi.	DISCHARGE			ANNUAL RUNOFF		
			Maximum Sec. Ft.	Minimum Sec. Ft.	Mean Annual, Acre Ft.	Mean Depth, Ins.	Per Sq. Mi. Sec. Ft.	
Idaho.....	Snake, Idaho Falls.....	10,100	54,300	2,000	9,380	6,800,000	12.65	0.93
	Boise, Boise.....	2,450	40,130	550	2,940	2,120,000	16.30	1.20
Kansas.....	Weiser, Weiser.....	1,670	17,040	10	1,211	877,000	9.86	0.73
	Neosho, Iola.....	3,670	45,560	0	1,528	1,104,836	5.67	0.42
Montana.....	W. Gallatin, Salesville.....	860	10,750	.00	981	710,000	15.50	1.14
	Missouri, Craig.....	17,615	28,650	1,740	5,100	3,800,000	3.94	0.29
Nevada.....	Yellowstone, Horr.....	2,635	15,500	285	2,880	2,180,000	1.48	1.09
	East Carson.....	415	5,540	290	760	550,000	24.89	1.83
New Mexico.....	Humboldt, Battle Mountain.....	7,800	3,131	5	624	452,000	1.09	0.08
	Truckee, State Line.....	955	15,300	205	1,146	830,000	16.32	1.20
Oregon.....	Rio Grande, Embudo.....	10,090	15,900	35	1,059	750,000	1.36	0.10
	Rio Grande, San Marcial.....	28,067	33,000	0	1,592	1,152,000	.77	0.06
	Willamette, Albany.....	4,860	188,000	1,870	14,736	10,669,000	41.21	3.03
	Owyhee, Owyhee.....	11,100	23,200	4	1,529	1,107,000	1.88	0.14
	Umatilla, Gibbon.....	353	8,400	45	520	377,000	19.99	1.47
	Columbia, Dalles.....	237,000	1,100,000	41,900	212,000	154,000,000	12.18	0.90
	Malheur, Vale.....	4,860	19,000	4	584	423,000	1.63	0.12
	Deschutes, Benham.....	4,760	1,330	1,696	1,228,000
	Powder, Salisbury.....	230	1,660	0	122	89,000	7.21	0.53

TABLE VII—DISCHARGE OF TYPICAL STREAMS OF THE WEST—Continued

State	River and Station	Area Basin, Sq. Mi.	DISCHARGE				ANNUAL RUNOFF	
			Maximum Sec. Ft.	Minimum Sec. Ft.	Mean Sec. Ft.	Mean Annual, Acre Ft.	Mean Depth, Ins.	Per Sq. Mi. Sec. Ft.
Oregon.....	Grande Ronde, Elgin.....	1,350	9,220	20	860	622,000	8.66	0.64
	John Day, McDonald.....	7,800	22,800	75	1,942	1,466,000	3.40	0.25
Texas	Rio Grande, Eagle Pass.....	300,000	1,080	5,525	4,000,000
	Pecos, Pecos.....	60,000	2	387	280,000
	Devils, Devil's River.....	120,000	245	554	401,000
Utah.....	Bear, Colliston.....	6,000	10,590	540	2,210	1,600,000	4.03	0.37
	Weber, Uinta.....	1,600	7,980	100	953	699,000	8.15	0.60
	Provo, Provo.....	640	2,600	140	519	376,000	11.02	0.81
	Sevier, Leamington.....	5,595	2,330	35	485	359,000	1.18	0.09
	Price, Helper.....	530	2,020	4	166	120,000	4.21	0.31
Washington...	Yakima, Kiona.....	5,230	30,000	612	5,125	3,710,000	13.33	0.98
	Spokane, Spokane.....	4,000	35,000	1,680	7,000	5,068,000	23.80	1.75
	Cedar, Ravensdale.....	149	13,600	110	681	493,000	62.17	4.57
Wyoming.....	Laramie, Uva.....	3,179	2,570	0	254	183,896	1.10	0.08
	North Platte, Pathfinder.....	12,000	33,000	130	1,949	1,411,000	2.20	0.16
	Green, Green River.....	7,450	21,400	160	2,095	1,517,000	3.82	0.28
Canada.....	Bow, Calgary.....	3,136	54,000	580	4,065	2,943,000	17.68	1.30

points in the basin extending over many years may, if intelligently studied, and interpreted by some actual measurements of the stream, sheds some light on the probable runoff, but cannot take the place of actual records of stream flow extending over a series of years.

A long record of stream flow of undoubted accuracy on a stream draining a basin adjoining the one in question, and similar in area, altitude and topography, may be available and of great value as indicating probabilities, but even this should be used with caution, and can by no means take the place of actual measurements of the stream in question.

Great caution should also be exercised in considering the reports of old inhabitants regarding the annual occurrence of great flood discharges, as these are likely to be exaggerated both in magnitude and frequency. Such floods make deep impressions on the average mind, while the years that glide by without them attract less attention, and are easily forgotten.

5. Subsurface Water Sources.—A part of the water which falls on the high regions soaks into the soil and entering the pores and seams of the rocks passes slowly along under ground to the lower regions, where some of it reappears as springs and some is recovered by means of wells.

Where the water-bearing stratum is overlain by tight material of great thickness, preventing the escape of the water to the surface, the pressure of the water from the hills upon that in the lower parts of the stratum may become considerable, and by piercing the overlying impervious strata by drilling machinery an outlet is furnished for the confined water and under the influence of the accumulated pressure it rises to the surface, forming an artesian well, which sometimes discharges its water with great force, depending upon the pressure. The great majority of wells, however, do not flow at the surface, but to be used must be raised by pumping.

Irrigation by means of wells is well adapted to individual effort, where conditions are favorable, as the construction of a well is often within the means of an individual, and the area it will irrigate no greater than he can control. The aggregate

area thus irrigated is very large in India, and has possibilities of great development in this country, although now relatively small as compared with the acreage irrigated from streams and reservoirs.

The water which enters the earth by percolation either from rain or from canals, reservoirs, or irrigation finds its way through the soil to some lower level where favorable geologic structure enables it to again reach the surface, or ultimately reaches a level which is comparatively saturated. The surface of this zone is called the water table, and varies greatly in depth below the ground surface in different localities. Its total amount is enormous.

a. Rate of Percolation.—This ground water is exceedingly slow of motion, both in porous sands and in the hardest rocks. It is known also that this ground or seepage water flows more freely at high than at low temperatures. At a mean depth of 6 feet below the surface perhaps one-third more water will flow in sand in the warmest than in the coldest part of the year. Among the most important conclusions on this subject are those of Mr. Allen Hazen, which for closely packed sand saturated with water are expressed in the formula

$$v = cd^2 \frac{h}{l} \left(\frac{t \text{Fahr.} + 10^\circ}{60} \right),$$

where v is the velocity of the water in meters daily in a solid column of the same area as that of the sand, or approximately in million gallons per acre daily;

c is a constant factor which present experiments indicate to be approximately 1000;

d is the effective size of sand grain in millimeters;

h is the loss of head;

l is the thickness of sand through which the water passes;

t is the temperature (Fahr.).

The formula can be used only for sands with coefficients below five and effective sizes from 0.1 to 3.0 mm., and with the coarser materials only for moderately low rates.

Mr. Hazen publishes a table in his book showing the rela-

tive quantities of water at different temperatures which passed through experimental filters. Taking as unity the quantity passing at 50° F., 0.70 passed at 32° and 1.35 at 71°; or for every three degrees increase in temperature the quantity of water passing increased by 5 per cent. In the above the effective size is the size of grain such that 10 per cent by weight of the particles are smaller than this. The uniformity coefficient is the ratio of the size of grain which has 60 per cent of the sample finer than itself to the size of which has 10 per cent finer than itself.

An idea of the slowness of flow of ground water may be had from the studies of Mr. N. H. Darton, who places the rate of motion in the sands of the Dakota formation at a mile or two a year. A French engineer gives the same rate, or an eighth of an inch a minute. In Arizona a rate of one-fourth of an inch a minute, and in Kansas three-eighths inch a minute, have been estimated. At Agua Fria, Arizona, the measured rate of flow of ground water in creek gravels having 28 per cent voids was 4 feet a day.

A thin film of water is held on each particle with extreme tenacity by a force called, "surface tension," and where the particles are fine the force of capillarity is also strong. In addition to this, the spaces between the particles are so narrow and tortuous that water cannot move through them except with great friction and extreme slowness. Experiments with the "permeable" materials of the North Dike at Wachusett Reservoir gave the following rates of percolation through a cross section of 1000 square feet, with a water slope of 10 per cent:

TABLE VIII.—PERMEABILITY OF SOILS

Material	Gallons	Ratios
1. Soil	51	1
2. Very fine sand	720	14
3. Fine sand	9,000	176
4. Medium sand	400,000	784
5. Coarse sand	2,200,000	4,353

The experiments of Slichter on various soils, upon the velocity of water at a temperature of 50 degrees, flowing upon a gradient of 100 feet per mile, gave results shown in the following table, compiled by Fortier:

TABLE IX.—VELOCITY OF PERCOLATION

Kind of Soil	Diam. Grains m.m.	VELOCITY	
		Ft. per Day	Mi. per Yr.
Silt.....	0.01	0.004	0.0003
	0.04	0.059	0.0041
Very fine sand.....	0.05	0.092	0.0064
	0.07	0.181	0.0125
Fine sand.....	0.10	0.369	0.0255
	0.15	0.832	0.0575
	0.25	2.305	0.1594
Medium sand.....	0.35	4.520	0.3125
	0.50	9.224	0.6377
	0.65	15.57	1.077
Coarse sand.....	0.80	23.62	1.633
	1.00	36.90	2.551
	3.00	332.10	22.960
Fine gravel.....	5.00	1067.00	63.770

From the above it will readily be seen that unless a well can be made to tap an extensive bed of coarse material, no large yield of water can be obtained from it.

7. Artesian Wells.—According to the common use of the term, an artesian well is one from which water flows at or above the surface of the ground. A broader meaning is any well in which the water rises considerably above the stratum to which it was confined before being relieved by the construction of the well. The former is the more generally accepted as well as the more practical definition.

In order that water may rise in a well to the ground surface, it must be under pressure, and so confined between relatively impervious deposits, that it can more easily escape through the well than elsewhere.

If a stratum of sand, sandstone, gravel, or other porous material is confined between relatively impervious strata of rock or clay, and is so inclined that one part of the open material is exposed to rain, and another part is depressed in the form of a basin, the water entering at the upper edge will percolate down the slope of stratification and accumulate in the basin, and place the water in the lower levels under such pressure as corresponds to the hydrostatic head of the water above it. If now the overlying clay be perforated by a boring, the water will rise in the bored well to the same height as the source from which the pressure is derived, and if this is sufficient to force the water to the surface, we have a flowing well.

The accompanying diagram, Fig. 11, illustrates the geological conditions of an artesian basin.



FIG. 11.—Ideal Section Illustrating Condition of Artesian Wells.

If the layer of sand be penetrated by a well drilled at *D*, the water will rise to a height regulated by the pressure of the water in the sand above the locality where the well reaches it.

The source of the water that rises in artesian wells is mainly the precipitation on the edges of the pervious beds where they come to the surface. In some instances the porous beds are charged in this way at their outcrops, hundreds of miles from where the water is liberated by drilling wells.

The height to which water rises in an artesian well, or, the height to which it would rise in a tube open at the top, if properly attached to the well, is termed the "artesian head." This is illustrated in the waterworks of towns, where the water rises in the distributing pipes to the same level as the surface of the water in the reservoir from which it is drawn.

Cases also occur of what are termed incomplete artesian basins, where an inclined bed of open material as sand or gravel thins out at its lower edge, and the impervious strata

above and below approach each other. This is illustrated in Fig. 12.

It will be noted that stratification and porosity are two necessary conditions and therefore massive, unstratified, crystalline rocks such as granite, schists quartzites and diorites, which are not porous, and are never underlain with porous stratified rocks, do not present favorable conditions for artesian wells. Where such rocks are exposed or occur near the surface of the ground, the prospects for artesian water are poor. The original bedding of such rocks has been generally obliterated by the changes they have undergone, and there is no succession of pervious and impervious layers.

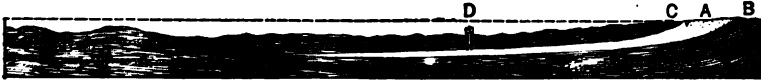

FIG. 12.—Ideal Section Illustrating Thinning Out of Water-bearing Stratum.

The condition of a flowing well depends on whether the pressure is sufficiently great to force the water above the surface. Frequently the water will reach within but a few feet of the surface, when an ordinary well or shaft can be excavated and the water pumped to the desired height. In many other cases the pressure is such that the water spouts forth from the well under pressure to considerable heights. In the San Gabriel and San Bernardino valleys in Southern California and many other regions, it has been found that after a number of wells have been sunk each additional well affects its neighbors by diminishing their discharge. There thus comes a point in the sinking of wells when the number which can be utilized in any given area or basin is limited.

a. Examples of Artesian Wells.—Some great wells have been sunk in different parts of the world. The celebrated Grinnell well in Paris commenced with a 20-inch bore and is gradually reduced to an 8-inch bore at the bottom; its depth is 1806 feet, and its yield has been as great as 1.5 second feet. A well has been bored in the neighborhood of Wheeling, West Virginia,

to the great depth of 4500 feet, but is dry. At Sperenberg, near Berlin, is a well 4170 feet deep, and at Schladabach, near Leipsic, is a well 5740 feet in depth. In St. Louis is a well which reaches a depth of 3850 feet, about 3000 feet below the sea-level. In San Bernardino and San Gabriel valley in Southern California and in the upper San Joaquin valley in the neighborhood of Bakersfield are some extensive artesian areas, and great artesian basins are found in the neighborhood of Waco, Texas, Denver, Colorado, and the James River valley and the neighborhood of Huron in the Dakotas.

b. Capacity of Artesian Wells.—The capacities of flowing wells are relatively small as compared with the volumes of water required in irrigation. Of the thousands of wells reported from the arid region comparatively few are of sufficient capacity for use in irrigation. The great majority range from 100 to 200 feet in depth, from 2 to 4 inches in internal diameter, and discharge rarely as much as 0.1 of a second-foot; though this volume, if stored in a suitably located reservoir, should irrigate a small farm. On the other hand there are, especially in South Dakota and Southern California, some very large flowing wells. In the former State there are reported to be at least twenty-five wells with discharges ranging from 1 to 6 second-feet, and in Southern California about thirty wells of similar capacities. The largest well in South Dakota delivers continuously about 6.68 second-feet.

c. Storage of Artesian Water.—An artesian well for irrigation should if possible be on the highest point of the land to be irrigated, and in such a position that it may be outside of and tributary to the reservoir in which the water is to be stored. Since artesian wells flow continuously during twenty-four hours of the day and three hundred and sixty-five days in the year, it is desirable to store as much of the water which flows during the non-irrigating period as possible, in order that the greatest duty may be gotten from the well. The volume flowing continuously from almost any well is usually too small to enable it to flow over the land in sufficient volume for the purposes of irrigation, so that a necessary adjunct to nearly every well is a

storage reservoir of greater or less dimensions. In the case, however, of a well which discharges about 1 second-foot, or enough to irrigate 100 acres from unstored flow, such a well may be made capable of irrigating several times this area if the water flowing at other times than the irrigating periods can be stored. Small reservoirs, sufficiently large to retain only enough water to produce the requisite head for flowing over, may be built as are watering-tanks on railways, or they may be cheaply excavated in the highest ground on the farm and properly lined. Larger ones may be constructed by making use of the natural configuration of the country and building a dam across a hollow or ravine.

d. Size of Well.—The yield of a well does not depend entirely upon its size. A 6-inch well will not necessarily discharge more water than a 3-inch well—perhaps not as much. The amount of flow depends directly upon the volume of the water-bearing strata and the pressure due to its initial head or source. Providing this is sufficiently great, then the discharge of the well is dependent on its diameter. Other things being equal, a large well will cost more to drill, but will be more easily and cheaply cleaned and kept in operation than a smaller one, which is apt to clog. Further, during and after drilling an accident may ruin a small well, while a larger one may be recased with diminished bore and still remain serviceable. For purposes of irrigation it may in general be said that a well less than 4 inches in diameter should not be drilled, and it is probable that one with a bottom bore greater than 8 inches will not be economical.

Nearly all wells which terminate in soft rock, sand, or gravel discharge more or less of these materials. To prevent this from clogging the well it is not uncommon to place perforated pipe in the bottom of the well through the water-bearing stratum. There are many styles of such pipe, but in general it may be stated that pipe with circular perforations of uniform diameter is not the most serviceable, as it is apt to become clogged. Some of the patented perforated pipes with slots having less aperture on the outer than on the inner surface are preferable. In some cases experience may show that it is not desirable to insert perforated

pipe, but to let whatever comes to the well be discharged and collected in the storage reservoir.

e. Manner of Having Wells Drilled.—There are many responsible firms who make a business of drilling and boring artesian wells, and for those who are unfamiliar with the business of well-sinking it is better to contract with some such firm to perform the work required. On the other hand, the sinking of a well is not a difficult operation for those who have any idea of the process, though by contracting they are certain of having the well sunk as they desire, within a fixed price, and are relieved of the risk of accidents.

In the oil and gas regions the drilling of wells to tap oil- and gas-bearing strata, which is a process entirely similar to that of drilling wells for water, is a matter of every-day occurrence, and nearly all who desire to sink wells perform the work on a sort of half-contract system. The principal apparatus comprises an engine, boiler, carpenter's rig, and set of drilling tools, and the common practice is for the owner to provide all except the tools and fuel and let the drilling of the well at so much a foot to a contractor who furnishes these and does the work of putting down the well.

f. Varieties of Drilling-machines.—Wells may be drilled by various methods, among the chief of which are by cables, poles, and hydraulic process. Provided the well is to be drilled by contract, it is of little importance what method is employed, since the contractor is responsible for the proper completion of the work, and the style of rig is a matter for his own choice. In the Dakotas and some other of the plains regions it has been found that wells drilled with pole machines have proved most satisfactory and performed the cheapest work, aside from the amount of time taken in coupling and uncoupling the rods. In the oil-and gas-bearing regions cable machines are most popular. There are many patterns of hydraulic, jetting, and rotary rigs which are adopted by different well-boring firms. The latter are dependent upon a rotary motion given to a piston-rod working by hydraulic power and turning a tubing with cutting edge. In hydraulic jetting machines, which can be used cheaply only in

gravel or sand, there is employed a short drill-bit having a hollow shank through which a jet of water is forced from pipe rods, thus creating an upward current which carries out the drillings. Some of these hydraulic and jetting machines have met with remarkable success.

The chief advantage of pole rigs over cable rigs is in the certainty of the revolutions given to the drill, as the rods form a rigid connection between the drill and the machine above, and the motion is uniform in the direction of tightening the screws of the joints. This tends to preserve the connection, and keep the drill under perfect control. Cable rigs are chiefly preferred because of the ease with which they can be operated and the speed with which the tools can be lowered and removed and the bailing apparatus substituted in their place. The chief disadvantages as compared with the pole rigs is in the greater friction produced by the corrugated surface of the cable, the uncertainty as to whether the striking bar reaches the bottom of the drill, the likelihood of cutting or bending the cable, and the danger of breaking under the strain when tools become fast. As the cable is rotated both to the right and left there is also liability of uncoupling the joints at the tools, and there is a possibility that the cable may not produce the proper rotation in the drill, and thus not bore the hole truly circular. There are now on the market a number of excellent portable well-drilling rigs, both of the old reliable walking-beam type (Fig. 13), and also jetting and hydraulic rotary rigs. These can frequently be purchased outright at prices which will render them cheaper than any other method of having wells drilled.

g. Process of Drilling.—The general process of drilling consists in having a long, heavy drilling-bar, the lower end of which is dressed to a cutting edge, which is dropped into a hole in the rock and by its weight cuts or breaks the stone where it strikes. At each blow this rod is turned a little, thus making the hole round. The drill is hung from the end of a cable or series of jointed poles which are raised and dropped by machinery. After the drill has worked for a short time it is removed, and the drillings, or small pieces of rock which have collected in the

bottom of the hole and deaden the blow of the drill, are removed. This is done by pouring water in the hole if it be dry, and the fluid mud thus formed is lifted to the surface by a long, narrow bailer with a valve at its lower end. These operations of drilling from 3 to 5 feet, then cleaning out the mud and drilling again, are alternated until the desired depth is reached. If casing or lining is to be introduced and the hole is not drilled truly

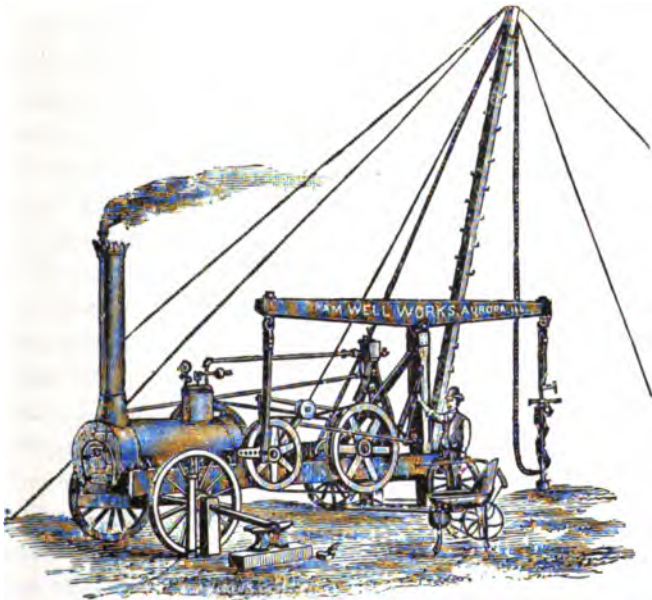

FIG. 13.—Portable Artesian-well Drilling Rig.

cylindrical, it is reamed out by a steel tool of desired diameter, weighing about 125 pounds and attached in place of the drill.

The apparatus which goes to make a drilling-machine comprises an engine and boiler of about 20 horse-power, a set of drilling-tools, and cable or poles. These latter are generally spoken of as the rig. It is also necessary to provide tubing or casing to line the well through such permeable strata as might cause the loss of water or through such strata as may provide water which is undesirable for the purposes required. It is sometimes necessary to line wells with tubing throughout their entire

length, and in such cases it is usual to begin with a large bore, say 8 inches, and after sinking this to a given depth, say 200 or 300 feet, to reduce the diameter of the tubing by an inch or two.

The "set of tools" which compose the drill—for the latter is not a solid bar, but several pieces—weigh about 2500 pounds, and consist of a steel "bit" or "drill," of the size of the bore desired, screwed into the lower end of the "auger stem," which latter is a steel rod 30 feet long and 3 inches in diameter. To the upper end of this are screwed "jars," and above them the "sinker-bar," which is 15 feet long and 3 inches in diameter, and of steel. The jars by slacking together in falling cause the sinker-bar to act on and through them to the drill as a hammer. The term "rig" generally includes, in addition to the set of tools, the woodwork and necessary iron fittings forming a derrick to carry a sheave at a sufficient height, perhaps 50 to 80 feet, to swing the drilling-tools clear of the ground; also, both wheels and shaft on which the drill cable is wound; the sand-reel for winding up the smaller rope used in cleaning out the drillings; a walking-beam to give vertical motion, and a band-wheel for transmitting power from the engine to the moving parts.

After the engine has been started and the walking-beam is made to rock up and down at the rate of 20 to 30 strokes a minute, lifting the tools with it, the length of stroke being adjustable from 15 inches to 3 feet, the rope is then twisted by means of a stick, first in one direction for a while and then in the opposite direction alternately. This twisting of the rope turns the drill, and the driller who handles the rope knows by the "feel" how the tools are working, the texture of the rock, and the occurrence of an accident. Occasionally the temper and set-screws are turned out a little, thus lowering the tools. After the drilling has gone on to a depth of 4 or 5 feet the tools are hoisted clear of the floor, the bull-rope swung off to one side, and the bailer or sand-pump is swung over the hole from the sand-reel, and is allowed to drop by its own weight, and upon reaching the bottom is filled with mud and sand through the valve at its lower end and is then drawn up and emptied; this process being repeated if necessary to clear the hole before drilling is again

resumed. The rate of drilling depends partly upon the character of strata encountered, but averages from 15 to 50 feet per working day.

A method of deep-well construction employed in California and known as the stovepipe method is admirably adapted to conditions where the material to be drilled consists of coarse débris. Casing from 10 to 14 inches in diameter is put down, reaching in one instance to 1300 feet in depth. A starter is used consisting of a length of 15 to 25 feet of No. 10 riveted sheet steel with a sharpened steel shoe. The remainder of the casing above is of No. 12 sheet steel in lengths of only 2 feet, each following section being smaller than the last so as snugly to telescope for 1 foot of length, thus forming a double shell of stovepipe casing. This is sunk by the ordinary oil-well type of machinery, the casing being forced down, however, by hydraulic jacks. After the well is sunk a cutting knife is lowered into it and vertical slits are cut in the casing opposite water-bearing strata.

The advantages of these methods are: absence of short fragile screw-joints; flush outer surface which does not catch in clay or projecting rocks; its elastic character permits it to adjust itself to obstacles and stresses; its cheapness for large sizes of casing; the short sections permit the hydraulic jacks to force it down; the ability to perforate the casing at any depth with a large size of perforation inside.

The cost of such wells averages about \$1 per foot for casing; \$40 for the starter; and for the drilling 50 cents per foot for the first 100 feet, thereafter 25 cents additional for each succeeding 50 feet.

h. Capacity of Common Wells.—The supplying capacity of common wells is frequently increased considerably by irrigation. As water is applied to the soil through a period of years the subsurface-water plane rises, and it may be reached at lesser depths than previously. In this way irrigation water may be used over several times; by pumping it from wells it may find its way by seepage back to the streams, from which it may be again diverted. The capacity of surface or common wells depends on the degree of fineness of the water-bearing stratum,

fine-grained material yielding water more slowly and of less amount than coarser material. The yield also depends on the head or depth below the surface of the water-table at which the flow takes place; also upon the size and shape of the excavation and character of the well walls or casing. The yield is directly proportional to the freedom with which the water-bearing material permits the movement of water, and also to the head or depth by which the water-table is lowered. Of a series of wells across the Rio Grande valley near Las Cruces, N. M., those near the river, in fine compact deposits of the valley bottom, have a small yield compared with the greater capacity of wells some distance from the river, under the mesa foot in the coarser mountain débris. If the well is shallow, increasing the diameter increases the flow; but if deep and relatively small in diameter, as a pipe, increasing the diameter does not appreciably increase the flow.

The extent to which common wells may be used as a source of supply for irrigation is not appreciated in the United States, where as yet irrigation is practiced only in a large way and irrigators are but just coming to a realization of the advantages of intensive cultivation, whereby but a few acres are worked by a single farmer, but in the most thorough manner possible. In a few portions of the Far West, notably in Central and Southern California, where Italians and Chinamen are engaged chiefly in market-gardening, wells are employed to some extent for the supply of water. In such cases the water is raised by one of several processes, chiefly by windmills, and by mechanical lifts worked by horse-power, and similar to the Persian wheel of Asia.

It is to India that we must look in order to gain an idea of the extent to which wells may furnish irrigation water. In the Central Provinces of India 120,000 acres are irrigated from wells. In Madras 2,000,000 acres are irrigated from 400,000 wells. In the Northwest Provinces 360,000 acres are irrigated from wells. Some of these wells are sunk to depths as great as 80 to 100 feet, in some cases through hard rock, and are capable in ordinary seasons of irrigating from 1 to 4 acres each. These

wells may really be said to supplement irrigation from canals and reservoirs, for after the waters of the latter have been used and have seeped into the soil they are caught by the well and are again used for irrigation. Thus wells as an adjunct to canals may be said to add materially to the duty of the latter.

8. Tunneling for Water.—Tunnels are sometimes driven in sloping or sidehill country to tap the subterranean water-supplies. These are practically horizontal wells, differing from ordinary wells chiefly in that the water has not to be pumped to bring it to the level of the surface, but finds its way by gravity flow to the lands on which it is to be utilized. Near the Khojak Pass in India is a great tunnel of this kind. This is run near the dry bed of a stream into the gravels for a distance of over a mile. The slope of its bed is 3 in 1000, its cross-section is 1.7×3 feet, and its discharge about 9 second-feet. The Ontario Colony in Southern California derive their water-supply from a tunnel 3300 feet in length, run under the bed of San Antonio creek through gravel and rock. Its cross-section is 5 feet 6 inches high, 3 feet 6 inches wide at bottom, and 2 feet wide at top. It is partly timbered and partly lined with concrete, having weep-holes in the upper part of the tunnel. Its discharge is about 6 second-feet. The supply from several subtunnels has been such as to average nearly 10 second-feet per linear mile of tunnel.

The Spring Valley Water Company which supplies San Francisco, California, has recently made some of the most extensive developments of water from subsurface sources yet recorded. One bed of gravel in a stream valley having an area of 1200 acres absorbs practically all the drainage of 300 square miles. Into these gravels were sunk 91 wells which yield 36 acre-feet of water per day. Another similar bed has been developed by drifting over 14,000 feet of tunnel 5 feet 6 inches \times 5 feet 6 inches with nearly as great a length of smaller branch tunnel. Into this drain several hundred driven wells (Fig. 14) which yield over 45 acre-feet of water per day.

a. Underground Cribwork.—Submerged cribs were planned for the American Water Company on Cherry Creek in Colorado, and have been used by the Citizens' Water Company on the

South Fork of the Platte River in Colorado. The former enterprise contemplated a submerged open crib sunk in the gravel bed of Cherry Creek, and resting on blue clay which is 73 feet below the surface of the stream, rising to a height of 70 feet, with its crest 3 feet below the bed of the stream. This was not to be a dam, but to stop the movement of that portion of the sub-surface water which might enter the cribwork. It would consist of timbers 14 inches in dimension at the bottom, decreased to 8



FIG. 14.—Subterranean Water Tunnel and Feed-wells: California.

inches at the top, placed 4 feet apart across stream, and planked on both faces with interstices of 3 inches on the upper face. The water caught in this cribwork was to be pumped to the surface.

The Citizens' Water Company develops the underground waters of the Platte River by means of a series of gathering-galleries, consisting of perforated pipe and open cribwork laid at a depth of from 14 to 22 feet below the surface of the gravel bed of the stream. The cribs (Fig. 15) are 30 inches square, and about a mile of these have been built running up the bed of the

stream, besides about a mile of perforated pipe 30 inches in diameter. The average daily yield obtained by these galleries is nearly 10 acre-feet of water, which is led off through the pipes by natural flow.

9. **Other Subsurface Water Sources.**—Earth waters may be gathered for irrigation by other means than springs, common or artesian wells, or tunnels. In the dry beds of streams in California submerged dams have been built which reach to some impervious stratum and cut off the subterranean flow, thus

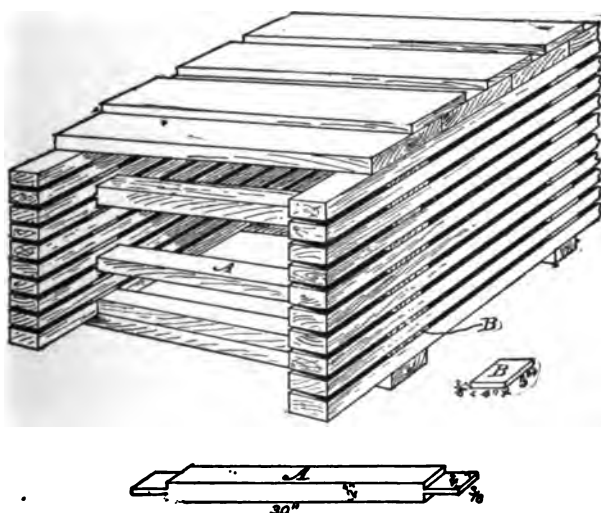

FIG. 15.—Gathering-cribs, Citizens' Water Co., Denver.

bringing water to the surface. In portions of the plains region, especially in Kansas, subsurface supplies have been obtained by running long and deep canals parallel to the dry beds of streams or in the low bottom lands and valleys. These canals, acting like drainage ditches, receive a considerable supply of water and lead it off to the lands. It may be generally stated that the amounts of water to be derived by such means are very limited and do not approach those claimed by the advocates of so-called "underflow."

10. **Character of Water.**—Practically all waters found in nature contain some dissolved mineral matter. Spring and

well waters usually contain more than surface storm waters. and those of the arid region more than those of humid regions. This follows from the fact that the soils of arid regions contain more soluble salts than those of more humid climes, because the latter have generally been more thoroughly leached.

Cases are numerous where small streams fed by mineral springs carry injurious salts in such quantity as to be unfit for irrigation, and to seriously impair the quality of rivers into which they flow. The amount of mineral which water may carry and still be suitable for plant consumption depends of course on the character of the salt, and in general the salts of sodium are most to be feared, in the order of carbonate, chloride and sulphate.

As a result of his investigations in northern Africa, Mr. Thomas H. Means states that the amount of soluble matter allowable in an irrigation water has been greatly underestimated, and that many sources of water which have been condemned can be used with safety and success with proper precautions. The Arabs in the Sahara he says sometimes grow vegetables with water containing as high as 800 parts of soluble salts to 100,000 parts of water, sometimes 50 per cent of the salts being sodium chloride. The Arab gardens consist of small plots 20 feet square, between which are drainage ditches dug to a depth of about 3 feet. This ditching at short intervals insures rapid drainage. Irrigation is by the check method and application made at least once a week, sometimes oftener. A large quantity of water is used at each irrigation, thus securing the continuous movement of the water downward, permitting little opportunity for the soil water to become more concentrated when the irrigation water is applied, and there is little accumulation of salt from the evaporation at the surface. What concentration or evaporation accumulation does occur is quickly corrected by the succeeding irrigation.

Under average conditions, however, where the total soluble salts exceed 300 parts in 100,000, water is objectionable for irrigating most crops, and if carbonates are present a lower limit is imposed, and if they predominate, a still lower limit must be set.

Waters which contain a moderate amount of salts may be entirely suitable for irrigation on soils having good drainage, but if irrigation with such waters is long continued and no measures are taken to prevent the accumulation of salts in the soil, they may in time impair its fertility. Deep drainage and occasional copious irrigation is the preventive and the remedy. These are treated at greater length in Chapter XII.

REFERENCES FOR CHAPTER V

- ALEXANDER, W. H. Relation of Rainfall to Mountains. *Monthly Weather Review*, 1901, p. 6.
- MEAD, DANIEL W. Hydrology. Part II. University of Wisconsin.
- TALBOT, A. N. Rates of Maximum Rainfall. *Technograph*, 1891-2.
- HOYT, J. C. Comparison between Rainfall and Runoff in the Northeastern United States. *Trans. Am. Soc. C. E.*, Vol. LIX, New York. Discussions of Above.
- KUICHLING, EMIL. Unusual Flood Discharges. *Trans. Am. Soc. C. E.*, Vol. LXXVII, p. 650.
- HENSHAW, LEWIS and McCAUSLAND. Deschutes River and Its Utilization. W. S. P. 344, U. S. Geological Survey.
- LARUE, E. C. Colorado River and Its Utilization. W. S. P. 395, U. S. Geological Survey.
- FOLLENSBEE and DEAN. Water Resources of the Rio Grande Basin. W. S. P. 358, U. S. Geological Survey.
- HENSHAW and DEAN. Surface Water Supply of Oregon. W. S. P. 370, U. S. Geological Survey.
- HENRY, A. J. Climatology of the United States. *Bulletin Q*, U. S. Weather Bureau.
- ALVORD, J. W. and BURDICK, C. B. Relief from Floods. McGraw-Hill Book Co., New York.
- HOYT and GROVER. River Discharge. John Wiley & Sons, New York
- Report of Special Committee on Flood Prevention. *Trans. Am. Soc., C. E.*, Vol. 81.
- CHAMBERLAIN, T. C. The Requisite and Qualifying Conditions of Artesian Wells. Fifth Annual Report, U. S. Geological Survey. Washington, D. C., 1884.
- DARTON, N. H. Preliminary List of Deep Borings. U. S. Geological Survey, Water Supply Paper No. 61. Washington, D. C., 1902.
- ENGINEERING NEWS. Sewage Purification in America. New York, February 23, 1893; July 18, 1894.
- HALL, WM. HAM. Irrigation in Southern California. Part II, Annual Report of State Engineer. Sacramento, 1888.
- HAMLIN, HOMER. Underflow Tests. Water Supply Paper No. 112, U. S. Geological Survey. Washington, D. C., 1905.
- HAY, PROF. ROBT., and Others. Geological Reports on Artesian Underflow Investigations. Department of Agriculture, Washington, D. C., 1892.

- HILL, PROF. ROBT. T., and Others. Same as preceding.
- JACKSON, LOUIS D'A. Hydraulic Works. W. Thacker & Co., London, 1885.
- MANNING, ROBERT. Sanitary Works Abroad. E. & F. N. Spon, London, 1876.
- NETTLETON, E. S. Artesian and Underflow Investigations. Department of Agriculture, Washington, D. C., 1892.
- NEWELL, F. H. Artesian Wells for Irrigation. U. S. Census Bulletin No. 193. Washington, D. C., 1890.
- ORME, S. H. Sewage Irrigation. *Engineering News*. New York, July 5, 1894.
- POWELL, J. W. Artesian Wells. Part II, Eleventh Annual Report, U. S. Geological Survey. Washington, D. C., 1890.
- RAFTER, GEO. W., and BAKER, M. N. Sewage Disposal in the United States. D. Van Nostrand Co., New York, 1894.
- SLICHTER, C. S. The Rate of Movement of Underground Waters. U. S. Geological Survey, Water Supply Paper No. 140. Washington, D. C., 1905.
- SPON, ERNEST. Present Practice of Sinking and Boring Wells. E. & F. N. Spon. London, 1885.
- HAMLIN, HOMER. Water Resources of the Salmas Valley, California. U. S. Geological Survey Water-Supply Paper No. 89, pp. 41, 42, 1904.
- MCADIE, A. G. Rainfall of California. California Univ. Pubs., vol. 1, No. 4, p. 179, Feb. 19, 1914.

CHAPTER VI

EVAPORATION

ALL the moisture that falls from the heavens must at some previous time have been taken from the earth by some form of evaporation. Conversely, all the moisture absorbed by the atmosphere is destined to fall again in the form of rain, snow, hail, etc. Hence in the long run, taking the earth as a whole, evaporation and precipitation are practically equal. Evaporation depends mainly upon the wind movement, and the temperature and relative humidity of the atmosphere. It also depends of course upon the presence of moisture to evaporate.

An important form of evaporation is the transpiration of moisture from the leaves of plants, in the process of growth. A growing crop usually transpires several times as much moisture as would evaporate from the same soil if no vegetation were present. Hence the importance of destroying weeds which not only consume the moisture but the plant food needed by the crop.

The evaporation from the surface of the earth varies widely, but the precipitation varies still more widely. In a region of prevalent fogs, evaporation is low, being zero during a fog, which may in fact precipitate some moisture. Where the atmosphere is very warm and dry the potential evaporation is correspondingly high. In a hot arid region, such as Southern Arizona, and Southeastern California, evaporation is at its maximum, and may reach 100 inches per annum. In the relatively cool and foggy regions such as Labrador, it may fall below 10 inches per annum.

Evaporation from a moist soil surface may be two or three times greater than from a water surface, by reason of higher temperature, if exposed to the direct rays of the sun. Shading

the soil decreases the evaporation 25 to 30 per cent, and a mulch of straw, leaves, or other loose material still more reduces it.

Experiments in Southern California by the Department of Agriculture showed that evaporation from the bare soil could be reduced 57 per cent by a 3-inch mulch, 81 per cent by a 6-inch mulch, and 87.5 per cent by a 9-inch mulch.

A soil mulch with similar effect may be produced by carefully pulverizing the surface soil, or in other words, by cultivation. The experiments showed a saving of 15 to 40 per cent of the evaporation by such cultivation.

The advantage of reducing soil evaporation by cultivation or mulching is not alone the saving of water effected but there are two other advantages that may be still more important.

Rapid evaporation causes rapid rise of soil moisture, which brings with it the soluble salts carried in solution by the soil water, and by evaporation leaves the salts on or near the surface, where they may in time, concentrate to a harmful extent.

By holding the soil moisture in the soil until it can be taken up by plants, it is given time to dissolve a larger amount of plant food, and thus greatly nourish the plants when absorbed by them; whereas, if evaporation is given full play, it soon exhausts the soil moisture, and fresh water must be more often applied, so that the water taken by the plants has not so much time to collect plant food and is less conducive to plant growth.

1. Measurement of Evaporation.—Several methods have been devised for measuring evaporation, which are more or less satisfactory. Elaborate and expensive apparatus has been employed in evaporation measurements made by Mr. Desmond Fitzgerald, chief engineer of the Boston Water Works, by Mr. Charles Greaves of England, and others. A simple apparatus and one quite successful as a means of measuring evaporation is that employed by the U. S. Geological Survey. It consists of a pan, Fig. 16, so placed that the contained water has as nearly as possible the same temperature and exposure as that of the body of water the evaporation from which is to be measured. This evaporating-pan is of galvanized iron 3 feet

square and 18 inches deep, and is immersed in water and kept from sinking by means of floats of wood or hollow metal. It should be placed in the water in such position as to be exposed as nearly as possible to its average wind movements. The pan must be filled to within 3 or 4 inches of the top, that the waves produced by the wind shall not cause the water to slop over, and

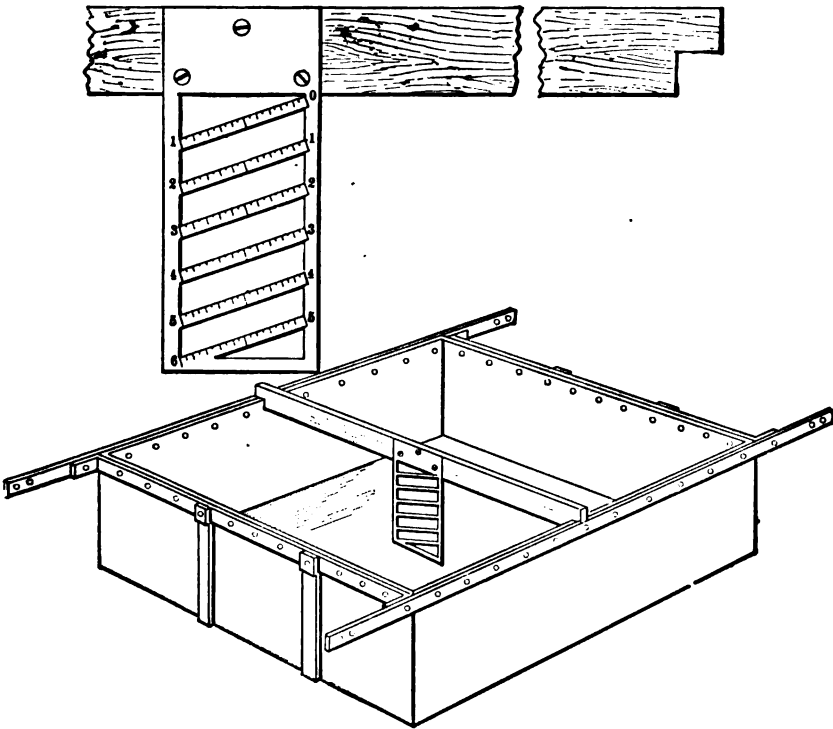

FIG. 16.—Evaporating-pan.

it should float with its rim several inches above the surrounding surface, so that waves from this shall not enter the pan. The device for measuring the evaporation consists of a small brass scale hung in the center of the pan. The graduations are on a series of inclined crossbars so proportioned that the vertical heights are greatly exaggerated, thus permitting a small rise or fall, say of a tenth of an inch, to cause the water surface to ad-

vance or retreat on the scale .3 of an inch. By this device, multiplying the vertical scale by three, it is possible to read to .01 of an inch.

In 1888 a series of observations were made with the Piche evaporimeter by Mr. T. Russell of the U. S. Signal Service to ascertain the amount of evaporation in the West. While it is probable that results obtained with this instrument are not particularly accurate, comparisons of these results with those obtained by other methods in similar localities show such small discrepancies that they may be considered of value until superseded by results obtained by better methods. Observations were made with this instrument in wind velocities varying from 10 to 30 miles per hour, from which it was discovered that with a velocity of 5 miles an hour the evaporation was 2.2 times that from one in quiet air; 10 miles per hour, 3.8 times; 15 miles, 4.9 times; 20 miles, 5.7 times; 25 miles, 6.1 times; and 30 miles, 6.3 times.

2. Amount of Evaporation.—In Table X is given the amount of evaporation by months in the year 1888 in various sections of the West as derived from experiments with the Piche apparatus.

As in the case of precipitation, evaporation decreases with the altitude because of the diminished temperature in high mountains. Experiments were made to determine the amount of evaporation in different portions of the West by the hydrographers of the U. S. Geological Survey. These were made with the evaporating-pan, and the results are probably (Table XII), more reliable than those obtained with the Piche instrument. These experiments were unfortunately conducted for a relatively short space of time.

3. Evaporation from Snow and Ice.—Some experiments were conducted at the Boston Water Works to determine the amount of evaporation from snow and ice. From snow it amounted to about .02 of an inch per day, or nearly $2\frac{1}{2}$ inches in an ordinary season. From ice it amounted to .06 inch per day, or about 7 inches in an ordinary season. The evaporation from snow is greater than this in the arid regions of the West, especially

on barren mountain-tops such as those in Arizona, Nevada, and Utah, where they are exposed to the wind and the bright sunshine.

TABLE X.—DEPTH OF EVAPORATION, IN INCHES PER MONTH IN 1887-88

Stations and Districts.	Jan. 1888	Feb. 1888	March, 1888	April 1888	May 1888	June 1888	July, 1887	August, 1887	Sept. 1887	Oct. 1887	Nov., 1887	Dec. 1887	Year
NORTHERN SLOPE:													
Fort Assinboine.....	0.8	1.2	1.2	3.1	4.1	4.2	6.8	5.5	4.8	3.5	2.5	1.1	39.5
Fort Custer.....	0.6	1.5	1.3	0.9	0.8	4.0	0.6	8.0	0.1	3.8	2.0	1.5	52.0
Fort Maginnis.....	1.1	1.4	1.1	0.3	3.3	4.6	6.8	4.6	3.8	2.4	2.0	1.1	53.8
Helena.....	1.1	3.6	2.1	0.1	3.3	5.5	7.2	7.7	0.4	4.4	3.0	2.1	53.4
Poplar River.....	0.4	0.8	0.8	2.7	4.4	5.7	6.0	4.4	4.4	2.4	1.7	0.7	35.4
Cheyenne.....	0.4	0.7	4.0	2.2	3.3	10.4	8.0	7.7	8.6	2.9	6.1	3.5	76.3
North Platte.....	0.8	1.8	1.8	5.4	3.9	6.9	6.0	4.8	3.7	2.8	2.3	1.1	41.3
MIDDLE SLOPE:													
Colorado Springs.....	3.0	3.3	4.1	6.7	5.6	4.3	6.7	7.2	6.8	4.6	4.2	2.9	59.4
Denver.....	2.8	3.7	3.5	7.6	5.8	10.3	8.3	8.5	6.1	4.9	4.2	3.1	69.0
Pike's Peak.....	2.1	1.3	1.5	2.1	1.8	1.9	3.0	4.0	3.0	2.2	2.8	1.6	26.8
Concordia.....	1.3	2.8	1.8	4.8	4.3	5.7	7.3	5.2	4.3	3.5	3.4	1.8	47.3
Dodge City.....	1.4	2.4	2.8	4.1	4.9	7.4	8.3	6.6	5.5	5.2	4.2	2.1	54.6
Fort Elliott.....	1.3	1.9	3.2	5.1	5.4	8.2	7.6	6.2	5.4	4.7	4.2	2.2	55.4
SOUTHERN SLOPE:													
Fort Sill.....	1.6	2.0	2.6	3.8	4.0	4.4	4.8	7.5	5.1	4.2	4.1	2.0	46.1
Abilene.....	1.8	1.7	3.1	4.2	5.0	5.8	9.5	7.5	6.2	4.5	3.4	1.7	54.4
Fort Davis.....	5.4	5.7	6.7	8.5	11.0	12.0	11.4	9.0	5.9	5.2	5.7	4.9	96.4
Fort Stanton.....	3.9	3.9	5.2	7.3	9.5	10.9	9.4	11.6	3.9	4.0	3.6	3.8	76.0
SOUTHERN PLATEAU:													
El Paso.....	4.0	3.9	4.0	8.4	10.7	13.6	9.4	7.7	5.6	5.2	4.6	2.9	82.0
Santa Fé.....	3.0	3.4	4.2	6.8	8.8	12.9	9.2	9.8	6.7	5.7	2.7	7.9	99.8
Fort Apache.....	2.6	3.0	3.6	6.8	9.4	9.1	7.1	6.7	5.3	3.4	4.1	2.6	65.9
Fort Grant.....	5.2	4.8	6.4	9.2	10.2	13.8	12.4	10.5	9.0	7.9	7.2	4.6	101.2
Prescott.....	1.4	2.8	3.6	5.4	6.2	8.1	6.6	6.5	4.7	4.9	3.6	2.2	56.0
Yuma.....	4.4	5.2	6.6	9.6	9.6	12.6	11.0	10.2	8.2	8.2	5.5	4.6	95.7
Keeler.....	3.0	4.6	6.3	8.7	9.3	11.9	12.8	13.9	10.6	8.8	5.9	4.8	100.6
MIDDLE PLATEAU:													
Fort Bidwell.....	0.8	1.8	1.8	4.6	5.2	4.0	8.8	8.1	5.0	4.6	2.4	1.3	48.9
Winnemucca.....	0.9	2.8	6.2	9.1	9.3	10.1	11.5	12.0	9.0	6.6	3.7	1.8	83.9
Salt Lake City.....	1.8	2.7	3.6	7.2	6.9	8.9	9.2	10.7	9.6	6.5	5.0	2.3	74.4
Montrose.....	1.8	2.7	3.7	6.2	7.0	11.1	10.2	8.3	6.9	5.2	3.4	2.0	68.3
Fort Bridger.....	1.6	2.5	2.7	4.3	4.3	6.5	7.7	6.8	5.6	4.2	5.2	4.7	56.1
NORTHERN PLATEAU:													
Boisé City.....	1.6	2.5	3.8	6.1	6.5	6.6	10.0	9.2	7.4	5.2	3.2	1.8	63.9
Spokane Falls.....	0.7	1.7	2.7	4.4	5.4	4.4	7.7	6.4	3.8	2.5	1.7	1.4	42.8
Walla Walla.....	1.1	2.9	3.6	6.2	7.7	5.7	9.9	7.9	5.1	3.4	1.8	2.4	57.7
N. PACIFIC COAST:													
Fort Canby.....	1.2	1.1	1.8	2.1	2.8	2.3	1.8	2.9	1.8	1.8	1.5	0.9	21.1
Olympia.....	1.3	1.2	1.8	2.5	4.1	3.3	3.2	3.1	2.4	1.5	1.3	1.1	26.8
Tatoosh Island.....	1.2	1.1	1.8	1.4	1.8	1.8	1.4	1.4	1.4	1.6	1.8	1.4	18.1
Roseburg.....	1.2	1.6	2.7	3.9	4.7	3.5	5.4	4.7	5.0	3.2	1.7	1.6	39.2
MID. PACIFIC COAST:													
Red Bluffs.....	3.0	4.6	5.4	6.1	7.0	6.9	11.0	10.7	10.1	10.5	5.9	3.6	84.8
Sacramento.....	1.8	3.1	3.7	4.3	4.2	5.6	5.9	5.6	6.5	7.3	3.9	2.4	54.3
S. PACIFIC COAST:													
Fresno.....	1.8	2.8	3.0	5.6	6.0	7.0	9.1	10.2	7.6	6.7	3.8	2.2	65.8
Los Angeles.....	2.3	2.0	2.8	3.4	3.0	3.8	3.2	3.5	3.1	4.1	3.0	3.0	37.2
San Diego.....	2.9	2.7	2.5	2.7	3.3	2.8	3.2	3.3	2.9	4.3	3.2	3.7	37.5

4. Evaporation from Earth.—The amount of evaporation from earth in the West is a doubtful quantity. Important experiments bearing on this were made in England between 1844

and 1875. From these it appears that the amount of evaporation from ordinary soil is about the same as that from water, sometimes exceeding it a little and sometimes being a trifle less, though

TABLE XI.—DEPTH OF EVAPORATION PER MONTH, IN INCHES

Year.	Place	Annual	Jan.	Feb.	March	April	May	June	July	August	Sept.	Oct.	Nov.	Dec.
1889	Fort Douglas, near Salt Lake City, Utah.....	10.5	5.7	4.9	1.0
1890		2.7	4.1	5.1	7.6	6.5	4.6	2.1	1.2
1891		3.2	4.8	5.2	7.6	6.5	5.2	2.5	1.4
1892		40.0	1.0	1.5	2.1	2.3	4.1	5.3	6.5	7.3	5.2	2.1	1.6
1889	Nephi and Provo.....	3.9	5.0	4.6	2.9	3.3
1889	Cherry Creek, Colo.....	8.1	7.9	8.6	6.2	4.2	2.5
1889	Canyon City, Colo.....	7.1	3.6	2.2
1890	Canyon City, Colo.....	3.8	4.8	5.2	7.3	6.0
1889	Fort Bliss, near El Paso, Texas.....	10.9	10.7	9.6	11.4	9.2	6.8	4.6	2.9
1890		2.0	2.0	7.0	7.3	10.8	11.7	9.6	7.6	3.7	3.0
1891		2.7	2.9	5.5	7.4
1892		91.6	2.4	3.2	6.0	7.5	10.0	13.0	12.5	11.9	9.2	6.8	4.2
1889	Tempe, Ariz.....
1890	5.8	5.5	5.6	6.6
1891	85.5	3.9	3.6	3.7	4.2
1890	Florence	5.8	8.2	11.5	13.5
1904	Yuma,	80.0
1890	2.0	2.8	7.2	8.5	7.2	7.1	4.3	3.6	2.5

generally averaging about 3 inches less than the corresponding evaporation from water surfaces. The evaporation from sandy surfaces was found to be only about one-fourth to one-fifth that from water. Thus in the observations of 1873, where the mean evaporation from water was 20.4 inches, that from earth was 17.9 inches and from sand 3.7 inches. Soil cover of any kind greatly affects the amount of evaporation. Assuming the evaporation from water is 1.00, Prof. B. E. Fernow gives it for bare soil 0.60; sod 1.92; cereals 1.73; and forest 1.51. Evaporation from ground covered with forest leaves is 10 to 15 per cent and sand 33 per cent less than from bare soil.

5. Effect of Evaporation on Water Storage.—The need of water storage for irrigation in the West chiefly occurs in July, August and September. Little rain falls in the arid region during this period, so that comparatively little of the loss of evaporation is replaced by rain. As an example, in Central California, where the average rainfall during these months amounts to a trifle less than 1 inch, the evaporation during the same period amounts to about 21 inches. The total resultant

deficiency chargeable to evaporation is about 20 inches. Storage reservoirs in the West are frequently at high altitudes in the mountains, where evaporation is less than in the hot lowlands. At Arrowhead reservoir, Cal., altitude 5160 feet, the measured evaporation averages 36 inches per annum, of which about 40 per cent occurs between May and August, the irrigation season.

The erratic stream flow in arid regions makes it desirable to store the waters of abundant years for use in dry years, and these extremes are often many years apart, and the water held in storage is thus subject to evaporation throughout the interval. In hot countries, where the rate of evaporation is high this places a serious handicap on the complete utilization of the water supply.

In 1909 and 1910, the U. S. Weather Bureau made a series of careful observations of evaporation at several stations, the results of which are given in table XII, page 72.

REFERENCES FOR CHAPTER VI

- WIDTSOE, J. A. Factors Influencing Evaporation and Transpiration. Bulletin No. 105. Utah Agricultural College, Logan, Utah.
- BUCKLEY, R. B. Irrigation Works in India and Egypt. E. & F. N. Spon, London.
- FORTIER, SAMUEL. Evaporation Losses in Irrigation and Water Requirements of Crops. Bulletin No. 177. Office of Experiment Stations. U. S. Dept. of Agriculture.
- BIGELOW, F. H. Records of Evaporation at 23 Different Stations. *Engineering News*, vol. 63, No. 24, June 16, 1910, New York.
- DURVEA, EDWIN, JR., and HAEHL, H. L. Evaporation from Lake Conchos, Mexico. *Trans. Am. Soc. C. E.*, vol. 80, New York.

EVAPORATION

TABLE XII.—EVAPORATION OBSERVED BY U. S. WEATHER BUREAU, INCHES

	Jan.	Feb.	Mar.	April	May	June	July	Aug.	Sept.	Oct.	Nov.	Dec.	Year
Salton Sea, 1500 feet inland.....	5.1	7.4	12.5	15.7	19.0	21.5	22.2	18.5	15.5	13.2	7.5	6.4	164.5
Salton Sea, 500 feet at sea.....	3.6	5.0	6.8	9.0	11.0	13.5	14.8	12.5	12.4	9.2	6.2	4.7	108.6
Indio, Cal.....	3.2	5.1	7.5	12.0	15.8	16.1	16.3	13.8	12.4	8.9	5.2	3.0	119.3
Mecca, Cal.....	2.9	5.0	8.1	10.9	12.7	14.2	15.2	13.2	10.3	8.2	4.1	3.0	107.8
Brawley, Cal.....	3.1	5.0	8.0	10.7	13.8	13.7	14.1	11.3	10.2	7.0	4.1	2.7	103.6
Mammoth, Cal.....	4.2	5.7	9.0	12.0	15.5	16.8	18.0	13.7	12.2	9.5	5.3	3.7	125.5
Granite Reef, Ariz.....	4.2	4.4	5.2	7.0	9.5	12.0	12.8	12.5	11.0	8.3	6.6	4.2	97.7
Yakima, Wash.....	1.8	2.5	6.2	7.9	8.4	8.9	10.7	9.4	5.5	3.2	2.0	1.5	68.0
Hermiston, Ore.....	1.2	1.2	3.0	7.3	7.9	9.5	12.0	11.1	7.4	3.9	2.0	1.5	68.0
Minidoka, Idaho.....	2.2	2.5	4.0	7.0	11.2	12.3	15.0	13.5	11.0	8.5	5.8	3.5	96.5
Deer Flat, Idaho.....	2.0	2.8	4.2	6.0	7.9	9.6	10.6	12.2	9.2	5.4	5.5	2.0	77.4
Dutch Flat, Neb.....	1.8	1.8	3.0	4.5	6.2	8.0	11.0	9.4	7.4	5.6	4.0	3.0	65.7
Kachess, Wash.....	0.5	0.5	1.2	2.6	3.8	5.5	5.9	5.5	4.4	1.5	0.8	0.5	32.8
Klamath, Ore.....	0.5	1.2	3.6	6.6	7.2	7.0	8.0	9.2	6.1	2.5	1.0	0.5	53.4
Fallon, Nev.....	1.8	1.8	2.2	3.2	5.2	7.9	9.9	8.7	5.1	3.4	2.5	2.0	53.6
Tahoe, Cal.....	1.8	1.8	1.8	2.0	3.0	4.2	6.2	7.1	6.2	3.6	2.5	2.0	42.2
Elephant Butte, N. M.....	2.5	2.7	4.5	8.0	11.5	13.4	11.6	10.5	8.6	6.8	3.9	3.0	87.0
Carlsbad, N. M.....	5.0	5.2	9.0	11.1	11.0	9.1	10.6	9.3	7.8	5.9	5.4	5.0	94.4
Avalon, N. M.....	4.5	4.5	5.5	7.5	10.1	11.0	12.9	12.0	9.5	7.0	5.8	4.5	94.8
Birmingham, Ala.....	1.5	1.5	2.2	4.4	5.9	7.3	7.4	7.3	6.0	4.0	2.3	1.5	51.3
California, Ohio.....	1.0	1.5	2.5	4.1	5.1	6.2	7.2	7.3	5.6	3.0	1.5	1.0	46.0
Lawrence, Kan.....	6.0	5.7	5.7	8.4	11.1	7.0	5.4	4.1	3.1

CHAPTER VII

PUMPING FOR IRRIGATION

THE practice of lifting water from a lower to a higher level for use in irrigation is doubtless as old as the art of irrigation itself, and was probably the first form of irrigation tried. In China, India, and other Oriental countries it is still customary to irrigate lands higher than the canals which conduct the water to them, lifting it a few feet by human or animal power. Many various devices of a primitive nature are still employed for this purpose. They are of course possible only where the lift is slight and labor very cheap.

The familiar processes of pumping water for stock and domestic farm use, and on a larger scale for a city water supply is apt to mislead many persons when considering problems of pumping for irrigation, owing to the relatively large quantity of water required for irrigation and the corresponding low unit value of irrigation water. For example a city of 30,000 inhabitants, covering say 1000 acres, might well afford to expend a million dollars or more for a domestic water supply, while an equal quantity of water would be necessary to irrigate 1000 acres properly, and an expenditure of one-tenth that amount for the water supply might for this purpose be prohibitive. In other words, the value of water for domestic purposes is often more than ten times as great as the value of the same quantity of water for irrigation. In fact, domestic water supply being indispensable, it must be obtained at any cost, and the value of irrigation water is limited by the value of the crops raised, in which it is only one element of cost.

Pumping for irrigation is therefore generally feasible only where the water supply is ample, the lift moderate and power

cheap. Exceptions to this combination occur only where the products of irrigation are exceptionally valuable.

1. **Ground-water Supply.**—Where an irrigation supply is to be obtained from the ground-water by means of wells, a careful study must be made of the quantity of water that can be made available from each well, and also the total supply, and the system carefully planned to accord with the facts developed by that study. One of the commonest errors made in irrigation engineering is the overestimate of the dependable supply of water from a well of given design. The total supply of ground water available in a given locality is also frequently overestimated, and seldom underestimated.

The ground-water supply depends not only on the presence of ground water at the site of the well, but also upon the facility with which additional water reaches the well as water is removed by pumping, and this in turn depends upon the size of the openings between the soil particles surrounding the well. If the water-bearing material is coarse sand or gravel in which the spaces occupied by water are relatively large, the water will move toward the well with comparative freedom as the water level in the well is lowered, and the yield from the well may be large, while if the water-bearing medium is clay or fine silt in which the interstices filled with water are very minute, the friction of moving is so great that the water moves through it with extreme slowness, so that the yield of each well is very small, although the total voids in the clay or silt may be and usually are greater in volume than those in coarse sand or gravel.

The pore space in soils of the arid region will average nearly 50 per cent, varying from about 40 per cent for clean sand, to 55 per cent for clay. A well-graded mixture, however, contains much less open space, and may have below 30 per cent. Each particle of soil under field conditions is enveloped by a very thin film of moisture which will not drain out, and can be driven off only by heat. The area of these surfaces is 6 or 7 times as great in clay as in coarse sand, and the number of particles is in similar ratio.

2. **Windmills.**—A great deal of irrigation has been done in primitive systems by the employment of the power of the wind, and this is still in extensive use for lifting water from wells for domestic use, stock water, and to irrigate gardens and small orchards. Wind power comes next to animal power not only historically, but in cost. Although the power is free, pumping by windmills is on the average more expensive than any other methods except those employing animal power. This is due to the relatively small amount of power developed by any one unit, the inconstancy of the wind, and the large amount of attention and repairs required by the windmills. For these reasons, the cost of pumping water for irrigation by windmills is generally prohibitive except for intense cultivation of small tracts from which large returns are expected, and in addition the lift must be low and other conditions favorable. Even then the cost is seldom less than \$100 per unit for first installation of well, storage tank and pumping machinery, and may reach several times that amount. Besides this the cost of maintenance is high, averaging over \$10 per year, while the area which one windmill can serve is generally less than an acre, and may be much less.

Windmills of standard make can be purchased of any large dealer in agricultural implements, but representations concerning the power to be developed by them should be usually discounted to eliminate optimistic assumptions, and liberal allowance should be made for the inconstancy of the wind.

Notwithstanding its relatively high cost a windmill plant may be the most advisable and economical plant where the requirements or the water supply limit the irrigation to less than one acre. Many farms on the great plains devoted mainly to grazing or dry farming are thus furnished with a reliable supply of vegetables and small fruits which contribute materially to the support and the health of the family.

Windmills are extensively used in the San Joaquin valley in California, on the great plains east of the Rocky Mountains and in other portions of the West, for pumping water for irrigation. The chief objection to windmills for this purpose is their

unreliability, as they are wholly dependent upon the force of the wind for their operation. This objection is not so serious on the great plains between the Rocky Mountains and the Mississippi River, where there is generally a wind to keep mills turning. In most other places they are less certain in their action, and may fail the farmer at the very time when he is most in need of a water-supply.

Because of their uncertainty of operation, windmills should never be used for purposes of irrigation without providing as an adjunct an ample tank or reservoir for the storage of sufficient water to irrigate a considerable area. Ample capacity should be provided to store the water of several days' pumping when irrigation may not be necessary. This storage capacity may be obtained by using one of the various forms of elevated tanks which are supplied by windmill makers; or, if the windmill can be located at a high point on the farm, an artificial reservoir may be excavated at this point and suitably lined, which shall have capacity to contain a larger amount of water.

It requires on an average a wind velocity of 5 or 6 miles an hour to drive a windmill, and on an average winds exceeding this velocity are to be had during only eight hours per day. Hence, about two-thirds of the total time is lost for work. The reports of the U. S. Weather Bureau indicate that the average wind movement of the entire country is 5769 miles per month, or about 8 miles per hour.

These averages are somewhat exceeded on the Great Plains, where the average hourly velocity is 10 miles. The following tables give roughly the force of the wind for ordinary velocities:

TABLE XIII.—WIND VELOCITY AND POWER

Miles per Hour	Feet per Second	Pressure per Sq. Ft. in Lbs.	Miles per Hour	Feet per Second	Pressure per Sq. Ft. in Lbs.
6	7.5	.12	30	44.0	4.4
10	14.7	.5	35	51.3	6.0
15	22.0	1.1	40	58.8	7.9
20	29.3	2.0	45	66.0	10.0
25	36.7	3.1	50	73.3	12.3

TABLE XIV.—ENERGY OF WIND ACTING UPON A SURFACE OF 100 SQUARE FEET

Velocity of Wind	At Sea-level	At 1000 Ft. above Sea-level	At 2000 Ft. above Sea-level
Miles per Hour.	H.P.	H.P.	H.P.
5	0.0835	0.0780	0.0724
10	0.6683	0.6237	0.5792
15	2.2550	2.1050	1.9550
20	5.3470	4.9900	4.6340
25	10.4400	9.7460	9.0500
30	18.0400	16.8400	15.6400

The following table is derived from Mr. A. R. Wolff's excellent work on the windmill, and shows the capacity and economy of an experimental windmill having various diameters of wheels, with an assumed average velocity of wind of 16 miles per hour and with eight hours per day as the average number of days during which the results given may be obtained.

TABLE XV.—CAPACITY OF WINDMILLS

Size of Wheel, Ft.	Revolutions of Wheel	GALLONS OF WATER RAISED PER MINUTE TO AN ELEVATION OF						Horse-power Developed
		25 Ft.	50 Ft.	75 Ft.	100 Ft.	150 Ft.	200 Ft.	
• 10	60 to 65	19.2	9.6	6.6	4.7	0.12
12	55 to 60	33.9	17.9	11.8	8.5	5.7	0.21
14	50 to 55	45.1	22.6	15.3	11.2	7.8	4.9	0.28
16	45 to 50	64.6	31.6	19.5	16.1	9.8	8.0	0.41
18	40 to 45	97.7	52.2	32.5	24.4	17.5	12.2	0.61
20	35 to 40	124.9	63.7	40.8	31.2	19.3	15.9	0.78
25	30 to 35	212.4	107.0	71.6	40.7	37.3	26.7	1.34

In designing a windmill for pumping, two things have to be considered—the torque, or statical turning moment, and the speed of the wheel in relation to that of the pump. The former should be as large as possible so that the mill will start with the faintest wind, and the latter must not be too fast for the pumps in a small mill or too slow in a large one. Hence the size of a

TABLE XVI.—CAPACITIES AND EFFICIENCIES OF SEVERAL WINDMILLS

	Stover Solid Hand-control Rudder	Perkins Solid Automatic Rudder	Althouse Folding Rudderless	Althouse Folding Rudderless	Carlyle Automatic Rudder
Outer diameter of sail-wheel, feet	11.5	16.0	14.16	10.16	9.83
Inner diameter of sail-wheel, feet	4.5	6.0	4.5	3.83	4.16
Gross area of sail-wheel, square feet	104	201	157	81	80
Weather angle at outer ends of vanes	43°	36°	30°	28°	50°
Diameter and stroke of pump, inches	3×4	3×10½	3×10	3×4½	3×4
Average head of water during tests, feet	29.2	61.2	66.3	38.7	30.7
AT MAXIMUM EFFICIENCY					
Velocity of wind, miles per hour	5.8	6.5	7.0	8.5	6.0
Velocity of mill, revolutions per minute	13.0	13.3	12.6	20.5	12.5
Actual horse-power	0.011	0.025	0.065	0.028	0.012
Horse-power per 100 square feet of gross area	0.011	0.042	0.41	0.035	0.015
Maximum net efficiency, per cent	8.7	14.4	19.3	9.0	10.4
IN 100 AVERAGE HOURS, CALM LOCALITY					
Average quantity of water lifted, gallons per hour	153.0	135.0	267.0	115.0	145.0
Average continuous horse-power developed per 100 sq. ft.	0.022	0.040	0.057	0.028	0.028
Average continuous gross horse-power developed	0.023	0.024	0.089	0.023	0.022
Average net efficiency, per cent	2.1	3.9	5.5	2.7	2.7
IN 100 AVERAGE HOURS, WINDY LOCALITY					
Average quantity of water lifted, gallons per hour	287.0	271.0	540.0	237.0	270.0
Average continuous horse-power developed per 100 sq. ft.	0.041	0.080	0.115	0.057	0.052
Average continuous gross horse-power developed	0.043	0.083	0.180	0.046	0.042
Average net efficiency, per cent	0.28	1.11	1.59	0.78	0.72

mill is an important element in the arrangement of its vanes. The angle between any portion of a vane and the plane of the wheel is termed the weather angle, and to obtain the greatest torque at starting the weather angle should be the complement of the best incidence angles, or between 70 and 55 degrees. In practice it is found that the weather angle is never as great as this, being in the best examples about 43 degrees.

Table XVI gives the results of Mr. J. A. Griffiths' experiments for the five American-made windmills tested.

3. Water-wheels.—Water-wheels may be subdivided into two classes: (1) vertical water-wheels and (2) horizontal water-wheels. Of the former we have the more common of the old-fashioned wheels:

1. Undershot water-wheels.
2. Breast-wheels.
3. Overshot water-wheels.
4. Hurdy-gurdies.
5. Tangential water-wheels.

The latter is a modern adaptation of the old-fashioned hurdy-gurdy, and is properly an impulse wheel. Horizontal wheels are turbines of various types, and in these, like vertical wheels, water may act both by pressure or impulse, or by a combination of the two.

a. Undershot Water-wheels.—The word water-wheel is usually applied to the various old-fashioned vertical wheels, undershot, breast, and overshot wheels. Undershot wheels may be classified as midstream wheels, the common undershot wheels, and Poncelet wheels. In midstream wheels the motive power is due to the velocity or impulse of the current of water in the stream in which the wheel is set, and such wheels are employed almost exclusively for the elevation of water for irrigation. They are very simple in construction and operation, and may be advantageously employed where water is abundant, even in streams having low velocity of flow.

In rivers where the water-level fluctuates, the axle of the wheel is made movable on its supports to render it capable of being raised or lowered at pleasure to suit the height of water-

level, and this is effected by resting one or both extremities of the axle on floats. The horse-power of a midstream wheel may be calculated by the following formula from Mr. P. R. Bjorling:

$$HP = (v - v_1) . 00284v,$$

in which v is the velocity of the stream in feet per second, v_1 the mean velocity of the float-boards in feet per second, and A the immersed area of the float-boards in square feet.

Numerous wheels of this class have been successfully employed in pumping water for irrigation in various portions of the West. In some cases these wheels have attached to their outer rim a row of buckets (Fig. 20), which dip into the water as the wheel revolves, are thus filled, and then as they reach the upper portion of their revolution spill their contents into a trough which leads to the irrigating ditch. Other forms of midstream wheels are connected by means of gearing or belting with pumps which elevate the water for irrigation.

The average diameter of the midstream water-wheel of the West varies from 10 to 20 feet and the length of the blade of the paddle from 6 to 10 feet. Some wheels of this variety but of large size have been successfully employed—notably on the Green River in Colorado which are from 20 to 30 feet in diameter. These are hung on wooden axles 5 inches in diameter, while their paddles dip 2 feet into the stream. On their outer circumference are buckets of wood having an air-hole in the bottom closed by a suitable leather flap-valve which permits the bucket to fill rapidly by forcing out the air. These buckets are 6 feet in length and 4 inches square, and have a capacity of a little less than a cubic foot each. The largest of the wheels on the Green River have 16 paddles and lift 10 cubic feet of water per revolution, and as they make two revolutions a minute, though they spill a large portion of their contents, each wheel handles about 4000 cubic feet per day, or approximately 1/10 of an acre-foot.

Common undershot water-wheels, as distinguished from midstream wheels, are the best where a fall of convenient height

cannot be obtained, and the velocity of the water is yet relatively great. These are confined in a channel which is made about the width of the wheel and is wider at the inlet than at the wheel so as to give freedom of access to the water and to increase its velocity. These wheels operate most satisfactorily where the fall is from $\frac{1}{2}$ to 2 feet in the course of the race. The paddles are similar to those for midstream wheels, though sometimes they are curved and of iron. The number of float-boards or paddles for such a wheel may be determined by the formula:

$$n = \frac{4d}{3} + 12,$$

in which n is the number of float-boards and d the diameter of the wheel. These wheels vary in diameter from 10 to 20 feet, and are usually constructed of from 30 to 40 paddles, varying from $1\frac{1}{2}$ to $2\frac{1}{2}$ feet in depth, their length being from 3 to 6 feet.

Poncelet wheels act rather on the turbine principle, their paddles being curved. They are usually immersed to the height of their axes, and the water is screened from them with the exception of a few inches near their under surface, so that it impinges by impulse against the under side of the wheel and acts much as does a turbine.

Breast-wheels are placed where there is a considerable fall in a manner similar to Poncelet wheels, so that the level of water is about at the height of their axes. They have usually curved paddles or buckets, and the water impinges against them both by weight and impulse at a point below the axial line.

b. Overshot Water-wheels.—Overshot wheels are more economical than undershot wheels in their use of water, and are therefore employed where water is scarce. In these the water is delivered above the wheel by means of a flume, race, or penstock, and they are so constructed that the water may be delivered either on the near or the far side of the wheel, according to the arrangement of the outlet gates controlling the supply.

On the outer circumference of the overshot wheel is a series of buckets into which the water pours and by its weight causes the wheel to revolve. As the wheel turns each bucket fills as it passes the inlet and empties as it approaches the bottom, so that on one side are always a certain number of buckets filled with water. In order to lose as little of the fall as possible the bottom of the wheel should approach close to the lower water surface, but should not dip into it, as by drowning the wheel its power is diminished.

The buckets of overshot wheels may be made of straight boards or sheets of metal having two or three bends in them, or may be curved. The number of buckets may be calculated by the following formula given by Bjorling: For wheels from 12 to 20 feet in diameter,

$$n = 2.1d;$$

and for wheels 25 to 40 feet in diameter,

$$n = 2.3d.$$

The depth of shrouding for these wheels is about 12 inches, and the bucket opening is about $\frac{1}{3}$ of a square foot for each cubic foot of bucket contents, or is about 7 inches in width.

Overshot water-wheels may be employed to operate through gearing or belting any of the usual forms of reciprocating or centrifugal pumps, and will elevate volumes of water to heights proportioned to the power they are capable of developing.

c. Turbine Water-wheels.—Turbine wheels may be divided into two classes, according as they are acted on (1) through pressure and (2) through reaction. Pressure wheels have curved float-boards along which the water glides. Reaction wheels consist of an arrangement of pipes from which water issues tangentially. To this latter class really belong Pelton wheels, which are vertical reaction wheels.

While pressure and reaction wheels are similar in construction, they differ in that in the former the passages between the vanes are not completely filled with water, while in reaction wheels the water fills and flows through the whole section of

the discharge-pipe. Turbines are again distinguished as (1) outward-, (2) inward-, and (3) mixed- or parallel-flow turbines. The former receive the water at the center and deliver it at the periphery of the revolving wheel, the regulating apparatus consisting of a ring inserted between the outer periphery of the guide-blades and the internal periphery of the revolving wheel. In inward-flow turbines the motion of the water, as the name implies, is practically the reverse of that for outward flow. Turbines possess an advantage over vertical water-wheels in that they may be used with any fall of water from 1 foot to several hundred feet. The chief differences between turbines and vertical water-wheels are that the turbines may be drowned, but vertical wheels must be elevated above the water in the tail-race; the turbine takes its supply at the bottom of the fall and the water-wheel at the top or beginning of the fall, and therefore the former obtains nearly the whole pressure due to the head or height of the fall; turbines work without material loss of energy when drowned and move with a greater velocity than vertical water-wheels, and hence may be reduced in size and weight for equal power.

Mixed- and parallel-flow turbines may be fixed at any convenient distance above the tail-race, and must have sufficient water above the guide-blades to allow it to enter freely without eddies.

Of the American makes of water-wheels probably the two most extensively employed are the Victor turbine and the Leffel turbine, though a number of other types are manufactured. These wheels have been extensively employed for all the various purposes to which power may be applied, and a number of pumping plants for irrigation operated by such turbines have been erected in the West. These turbines come in sizes and powers ranging from a few inches in diameter under a head of but a few feet, and capable of developing as little as one horse-power, up to the enormous sizes which have recently been built which are capable of developing as much as 20,000 horse-power, and which may be operated under several hundred feet of head.

d. Pelton Water-wheels.—Pelton water-wheels are simple in construction and not liable to be clogged or to get out of order, and can be worked under great heights of fall. They are vertical, tangential reaction wheels, and power is derived from the impulse of the head of water supplied by a pipe which discharges upon the wheel-buckets on the lower side of the wheel through a nozzle. The buckets which are on the periphery of a Pelton wheel are of metal, cup-shaped, and divided into two compartments in such way as to develop the full force of the impinging stream, while in passing out the water sweeps the curved sides with a reactionary influence, giving it the effect of a long impact. The power of this wheel does not depend upon its diameter, but upon the volume and head of water supplied. Pelton wheels are not recommended for heads less than 50 feet, as below this head turbines are usually more efficient. But above 200 feet head and up to 2000 feet a Pelton wheel is best, as no other wheel produces like efficiency or works with equal simplicity. These wheels are adapted to a wide range of conditions of water-supply, producing power under the most varying conditions with efficiency. This is accomplished by simple change of nozzle-tips, by varying the size of stream thrown upon the wheel, or by shutting off one or more of the multiple nozzles, the power of which may thus be varied from maximum to 25 per cent without appreciable loss. The buckets being open, there is no uncertainty or annoyance from derangement of the parts, or stoppage by driftwood or other substances in the water. They are relatively cheap of installment, and may utilize the water from a small spring or creek as well as from the largest source of supply. These wheels admit, by varying their diameter, of being placed directly on the crank-shaft of power pumps without intermediate gearing or connections.

4. Internal Combustion Engines.—The development of the gas and vapor engines actuated by internal explosions are not only relatively economical of fuel, but are adaptable to small units, and are so nearly automatic as to require only occasional visits to keep them running properly, and when out of order merely stop until the difficulty is remedied. These important

advantages have given them a prominent place in the field of individual pumping plants. Their most important handicap is the high grade of fuel required, generally either gasoline, or other volatile oils called distillate. A greater economy in the fuel used by such engines is sometimes obtained by producing the gas consumed from oil or coal in the plant itself. The lignite outcropping abundantly in some regions is well adapted to this use.

5. Hot-air, Gasoline, and Alcohol Pumping-engines.—Hot-air pumping-engines depend for their operation on power developed by the expansion of heated air without the interposition of steam or other agency to convert the heat into motion. Alcohol and gasoline-engines are likewise operated without converting the heat produced by combustion into steam, but depend upon the expansive force produced by the explosion of alcohol or gasoline converted into gas when brought into contact with air. They have, under certain conditions, decided advantages over water- and steam motors in that they can be employed where there is not a sufficient water-supply to operate a water-motor, utilizing, as they do, practically no water, and therefore being able to pump all that is available for irrigation. They may be employed where steam-pumps cannot be, both because of their economy in water consumption and because of the kinds of fuel which they may use; gasoline and alcohol being serviceable in arid regions where transportation of fuel is expensive and hot-air engines being capable of utilizing any variety of fuel. They are compact, and simple of erection by comparatively unskilled machinists, and can be operated at the least expense for supervision. Denatured alcohol is efficient fuel when utilized in a specially designed alcohol engine, of which there are several successful makes on the market. Such alcohol can be made on the farm from waste or refuse vegetables, fruit, or grain.

Hot-air engines are constructed almost wholly as pumping-engines, and the motive power and pumping apparatus are combined in one machine inseparably connected. Many thousands of these machines are in use, chiefly for pumping small

quantities of water in cities for manufacturing or domestic uses, only a few being employed in pumping water for irrigation. They are simple of construction and there is no possibility of explosion, as may occur through carelessness with a gasoline-engine. When once started they require no further attention than the replenishment of fuel.

Gasoline- and alcohol-engines are used extensively in some portions of the West, notably in Kansas, for pumping water for irrigation. They are made of various dimensions, pumping a corresponding volume of water, and they are constructed as combined motive and pumping plants or as separate motors to be attached to various forms of pumps. The chief advantages which these machines have are their compactness and simplicity of installation and operation, and their cheapness.

6. Steam Power.—Some of the largest irrigation pumping plants in existence in point of power developed and water pumped are actuated by steam power. In the Hawaiian Islands large steam pumps are employed to lift water as much as 550 feet for the irrigation of sugar cane. The crop must be very valuable to justify any such lift. Very large steam plants for low lifts and large quantities of water are employed upon the rice plantations of Louisiana. The large plants have employed the reciprocating engine and pump direct-connected, or steam pump. For some cases a higher efficiency may be obtained by the use of steam turbines which are especially, on account of their high speed, adaptable to the actuation of electric generators, which in turn may furnish current to a number of pumps installed at different localities. Where the water is to be obtained from numerous wells, this method of distribution is especially advantageous. A steam plant to be economical must be large, as it requires continuous attendance and must have elaborate provisions for economy of fuel. The investment in such a plant and the area irrigated are usually beyond the means of the individual irrigator, and most successful plants of this character are handled by large corporations or municipalities.

7. Pumps.—Although other types are used, the centrifugal pump dominates the irrigation field.

Centrifugal pumps lift water by means of a disk bearing curved blades which revolves rapidly within a chamber, which fits as closely as possible to leave clearance for rapid motion. The blades force the water through the delivery pipe. They are sometimes submerged in the water to be pumped, or may be placed a few feet above the water, in which case they require priming to start them. Centrifugal pumps are of several varieties, differing in form or detail, but acting on the same principle.

The centrifugal type of pump is the favorite where large volumes of water must be lifted through a moderate elevation. Its main advantages are simplicity, reliability, low cost, and freedom from serious trouble with silt, leaves, etc. When properly designed for the conditions under which it is to operate it shows efficiencies above 80 per cent for heads between 30 to 60 feet, with somewhat less outside those limits. The loss at entrance of suction pipe is over 90 per cent of the velocity head at entrance, and at the exit of the discharge pipe the loss is the entire velocity head. These losses can be greatly diminished by tapering the pipe to larger section in both directions from the pump. To be fully effective, however, the taper must be very gradual, especially at the discharge end.

Prof. W. B. Gregory gives the following table as an illustration of the advantage of expanding the suction and discharge pipes in directions away from the pump. It also illustrates the fact that this is more important at the discharge than at the suction side:

TABLE XVII.—CENTRIFUGAL PUMP, 5 FEET LIFT

Form of Pipe	Loss of Head at Entrance	Loss of Head at Discharge	Friction Loss, Straight Pipe	Total Head	GAIN	
					Feet	Per cent
Straight 2 ft. diameter.	1.44	1.55	0.24	8.23	0	0
Expanded to 2 ft. 6 in.	0.59	0.63	0.24	6.46	1.77	21.5
Expanded to 3 ft.	0.28	0.31	0.24	5.83	2.40	29.1
Expanded to 4 ft.	0.09	0.10	0.24	5.43	2.80	34.0

The screw pump pushes the water along by means of an inclined plane in the form of the threads of a rapidly revolving



FIG. 17.—Windmill and Reservoir near Garden City, Kansas.



FIG. 18.—Battery of Hydraulic Rams, Yakima Valley, Washington.



FIG. 19.—Undershot Water-wheel.



FIG. 20.—Current Wheel or Noria, Lifting Water from Salmon River for Irrigation.

screw, working inside a pipe. It is especially adapted to low heads, as it does not require the water to move with as high a velocity as the centrifugal pump requires, and may achieve efficiencies of 70 per cent for heads as low as 6 or 8 feet.

Another type of pump advantageous for low heads is the scoop wheel, a view of which is shown in Fig. 22. It is an adaptation of the old-fashioned paddle wheel used on river steamers. The paddles push the water up a curved trough fitting them closely without touching. It moves the water so gently that its efficiency is almost independent of the lift, but it cannot be well adapted to high lifts. Efficiencies of over 60 per cent are attainable.

8. Direct Pumping.—It often happens that the location of a canal on the adopted grade reaches a point where it encounters topography so rough that economy requires it to be dropped to a lower level, and there may also be irrigable land at higher level, near by, which it is desirable to reach. In such a case it may be possible to utilize the power generated by the falling water at the drop, to raise a portion of it to a higher level. Where this is done at the same point with one installation of machinery, this is called a direct-pumping plant. Several such plants have been installed by the United States Reclamation Service, a typical one being that on the Huntley Project, Montana, where the main canal carries 200 second-feet of water which descends a vertical distance of 34 feet, through a pressure pipe into a casing enclosing a centrifugal pump mounted on a vertical shaft above a turbine water-wheel on the same shaft. One hundred and fifty second-feet of the water passes through the turbine into the canal below, thus turning the shaft and actuating the centrifugal pump which lifts 50 second-feet of the water to a level 45 feet above that of the main canal. This machine was built under a requirement of 51 per cent efficiency and approximates this in practice.

It is seldom that the velocity of highest efficiency is the same for both water-wheel and pump, and hence it sometimes occurs that higher efficiency can be obtained by a separate installation of these two machines, connecting them by gearing or belting to secure the best velocity in each.

9. Hydraulic Ram.—The commonest form of direct pumping plant is the hydraulic ram. This uses a large volume of water falling a moderate distance, to pump a smaller quantity of water through a greater head. In this device, a pipe (*A*) leads from the source of supply to a valve box (*B*) and sends a branch to an air chamber (*C*), from which the delivery pipe (*D*) leads to the higher level. The valve in the valve box opens downward, and is made heavy enough to remain open with a moderate flow of water but closes suddenly when the velocity of the escaping water reaches a certain point. When the valve closes the rushing water is suddenly checked, producing a water hammer which opens the valve into the air chamber and compresses

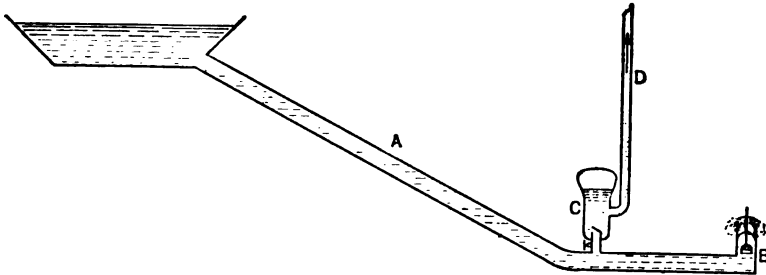

FIG. 21.—Diagram Illustrating Principle of Hydraulic Ram.

the air, and is relieved in part by flowing into the delivery pipe. When the pressure equalizes, the air chamber valve closes, and the flow through the delivery pipe is continued for a brief period, by the expansion of the compressed air in the air chamber. As the air in this chamber is gradually absorbed and carried out by the water, provision must be made for its renewal, or the efficiency of the ram will decrease. When the water in the supply pipe is quiet, the valve in the valve box (*B*) falls, the flow of water begins again, and the process is repeated.

Thus, the flow from a hydraulic ram is a series of pulsations, and each impulse has to overcome the inertia of the column of water in the delivery pipe. If two such rams are connected with the same discharge pipe, and their pulsations do not coincide, the discharge is more nearly continuous, and less energy

is wasted; and this becomes still more the case, as the number of rams is increased. An installation of eleven hydraulic rams in the Yakima Valley gave an efficiency of over 71 per cent when quite old, while a single ram will seldom give better than 50 to 60 per cent efficiency. Like other mechanical appliances, however, the hydraulic ram is susceptible of great ranges in efficiency, and a battery of two 12-inch rams installed at Seattle, are reported by Carver to have shown efficiencies as follows:

TABLE XVIII.—TESTS OF 12-INCH HYDRAULIC RAM,
SEATTLE, WASH.

Strokes per Minute	Power Head Ft. <i>H</i>	Pumping Head Ft. <i>h</i>	Water Wasted c. f. s. <i>Q</i>	Water Pumped c. f. s. <i>q</i>	Efficiency Per cent $\frac{q(h)}{(Q+q)H}$
65	48.7	130.7	1.08	0.555	90.8
50	48.0	131.6	1.53	0.755	90.5
45	48.0	133.8	1.78	0.846	89.6
41	47.9	131.2	1.91	0.915	88.8
40	47.9	133.8	2.04	0.930	87.5
37	47.9	127.8	2.04	1.020	89.0
32	47.8	135.9	2.66	1.080	82.3

10. Air-lift Pumping.—Water is sometimes pumped from wells by means of compressed air, by forcing the air through a pipe to the bottom of the well casing and there releasing it. This method can be used only for vertical lifts from wells of considerable depths. It is not applicable to lifts of more than 200 feet, unless the lifts are arranged in series.

The area of the air pipe should be between 15 per cent and 20 per cent of that of the water pipe, and from one-half to two-thirds of the air pipe should be submerged. Under favorable conditions an efficiency of about 30 per cent is attained, although results in practice are usually lower, and laboratory tests may be higher. The system is well adapted to sandy water, as there is no machinery or valves to wear. It is little used on account of low efficiency.

11. Hydro-electric Pumping.—Where the pumping is to be performed at a distance from the drop where power can be

generated, electric power may be generated at the drop, and transmitted over wires to one or several points where pumping is required. Such pumping may be from canals, or from wells drawing upon the ground water, and opportunities for their installation are very numerous in irrigated regions, and in fact occur on nearly every large irrigation system.

The largest existing hydro-electric installation for irrigation pumping is at the Minidoka dam on the irrigation project of the same name built and operated by the United States government.

At this point, a dam was built in Snake River to raise the water into canals on each side of the river, 38 feet above the bed of the river. The main dam is of loose rock faced with gravel and earth, and its south abutment at the river bank merges into a concrete weir built on the lava bench, which serves as a spillway, about 3000 feet long. The weir is surmounted by a series of buttresses against which are placed flash boards to serve as a movable crest to store flood waters for irrigation. The available storage capacity above the level necessary for diversion purposes is about 54,000 acre-feet. Below this dam about 300,000 acres of land are irrigated, the water for which must pass the dam and is available for the development of power under such head as the dam affords, which is about 46 feet on an average.

The present development consists of five 2000-horse-power vertical turbines, direct connected to 1500 k.v.a. alternators, generating 3-phase 60-cycle current at 2300 volts. The turbines operate under a normal gross head of 46 feet at a speed of 200 r.p.m.

The current from the alternators is transformed from 2300 volts to 33,000 volts, by five transformers of 1500 k.v.a. capacity each. This current is transmitted over duplicate copper transmission lines, a distance of 11 miles by the shortest line to the nearest pumping station.

At the lower end of the south side gravity canal is located the first pumping plant, which consists of four centrifugal pumps with capacity of 160 second-feet each, and one pump of 75 second-feet capacity, or a total capacity of 715 second-feet.

The lift is 31 feet net, and at this level a canal carries water to cover about 10,000 acres. Another canal runs in cut to a suitable location for the second pumping station which is equipped with four pumps of 160-second-feet capacity each, which lift the water 31 feet higher, from which level about 15,000 acres are irrigated, and the balance of the water is carried to the third pumping station, which has two pumps of 160-second-feet capacity each and one of 75-second-feet capacity, and supplies about 23,000 acres of land. The lift at each station is about 31 feet and

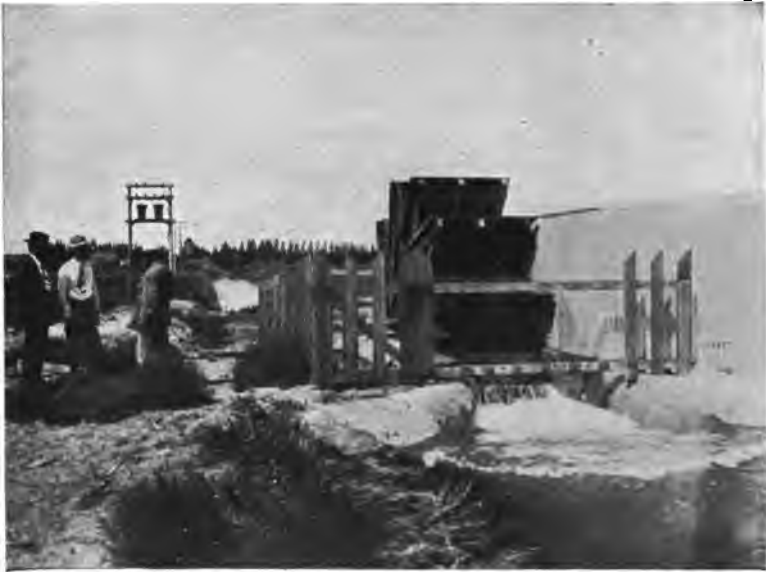

FIG. 22.—Scoop Wheel, Lifting Water $3\frac{1}{2}$ feet, 60 per cent Efficient.

the average lift is about 64 feet. All the pumps are of the vertical shaft type submerged, with both top and bottom suction, located in separate concrete chambers, 16 by 17 feet, protected by steel trash racks. The larger pumps have impellers of 44 inches diameter and discharges 48 inches diameter, giving a discharge velocity of 10.4 feet at rated capacity, and a speed of 300 r.p.m. The casing of the pump is of cast iron, and the impellers are of steel plate with cast-iron shroud rings. The discharge pipes gradually enlarge to 66 inches diameter and are

merged into reinforced-concrete pipe, reaching to the top of the lift, where it is equipped with a steel flap valve which remains open while the pump is operating, and closes when it stops. The motive power for the pumping unit is furnished by a 600-horse-power 3-phase synchronous motor, wound for 2200 volts, to which pressure the current is transformed from the transmission voltage of about 30,000. All the pumping stations are housed in buildings of reinforced concrete.

The electric current is also transmitted to numerous small pumping stations where it is necessary to lift water from 3 to 5 feet to cover a few hundred acres. This is accomplished by steel scoop wheels with an efficiency of about 60 per cent.

12. The Humphrey direct-explosion pump is used at Del

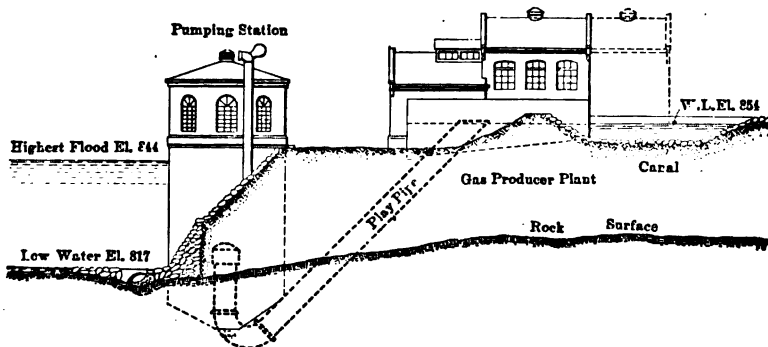

FIG. 23.—Direct-explosion Pumping Plant to Raise Irrigating Water.

Rio, Texas, to pump about 60 cubic feet per second to a height of 37 feet from the Rio Grande. This type of pump has few moving parts and combines the prime motor and pump in one structure, consisting mainly of a simple system of pipes, valves, and tanks, as shown in Fig. 23, using gas produced at the site. To start the pump, the proper mixture of air and gas is forced into a cylinder by a small air compressor of the two-cylinder type, one cylinder pumping air and the other pumping gas.

After the proper mixture of air and gas is forced into the cylinder by the compressor, the charge is fired by an electric spark, all the valves being shut at the instant when the explosion

occurs. The charge of gas and air is exploded directly over the surface of the water, no piston or moving parts being used. The increase in pressure resulting from the explosion, all valves being closed, drives the water in the pump-head downwards and sets the whole column of water in the play pipe in motion. This column of water attains kinetic energy during the period when work is being done upon it by the expanding gases. By the time the gases resulting from the explosion have expanded to atmospheric pressure the water in the play pipe is moving at a very high velocity. As the motion of this column of water cannot be suddenly arrested the pressure in the explosion chamber falls below atmospheric pressure. When this occurs, a quantity of water enters through the suction valves, most of which follows the moving column in the play pipe and the rest rises in the explosion chamber.

As soon as the column of water in the play pipe comes to rest, it starts to move back towards the pump and gains in velocity until the water reaches the level of the exhaust valves which are shut by impact. A certain quantity of the burned products mixed with the scavenging air is now imprisoned in the cushioned space and the kinetic energy of the moving column is expended in compressing this gas cushion to a very much greater pressure than due to the static pumping head. As a result of the energy stored up in the entrapped compressed gases, the column of water is again forced outward. The pressure in the gas head is again reduced to atmospheric pressure and below, at which a fresh charge of gas and air is drawn in to the explosion chamber. Again the column of water returns under the pressure in the play pipe, compresses the charge of gas and air which is then ignited to start a fresh cycle of operation.

The period of cycle of the pump is determined primarily by the length of the reciprocating column of water in the play pipe. As a general rule, assuming the column to be of a uniform section, the period of vibration is almost proportional to the square root of the length of the water column. The Del Rio pump will average about twelve complete cycles per minute.

The thermal efficiency of the pump is guaranteed to be not

less than 20 per cent. English pumps of this type have reached a thermal efficiency of over 22 per cent.

13. **Rice Irrigation.**—The irrigation of rice in Louisiana is an important industry, and this has become one of the staple crops of the state. It was formerly customary to place flumes in the levees of the Mississippi River to admit water to the rice fields, but the menace to the safety of the levees led to the prohibition of this practice, and thereafter siphons have been used to lift the water over the levees. At low water it is generally necessary to pump the water from the river to supply the siphons.

Large quantities of rice are also produced on the uplands, to which water is pumped to various heights, sometimes more than 50 feet. The quantity of irrigation water applied in a season varies with the season and the soil, from 1 to 3 feet in depth, averaging about 2½ feet.

TABLE XIX.—PRODUCTION OF RICE, 1917, IN UNITED STATES

State	Acreage	Yield per Acre, Bushels	Production, Bushels	VALUE AT FARM	
				Total	Per Acre
North Carolina.....	300	26.0	7,800	\$16,000	\$50.70
South Carolina.....	3,000	25.0	75,000	146,000	48.75
Georgia.....	900	30.0	27,000	53,000	58.50
Florida.....	800	26.0	20,800	41,000	50.70
Missouri.....	400	45.0	18,000	34,000	85.50
Alabama.....	400	27.0	10,800	23,000	51.30
Mississippi.....	2,100	30.0	63,000	120,000	57.00
Louisiana.....	500,000	36.5	18,250,000	34,675,000	69.35
Texas.....	230,000	27.0	6,210,000	12,420,000	54.00
Arkansas.....	146,200	41.0	5,994,000	11,389,000	77.90
California.....	80,000	70.0	5,600,000	9,800,000	122.50
United States.....	964,100	37.6	36,276,400	\$68,717,000	\$71.28

The use of the centrifugal pump is nearly universal on the rice plantations for small installations designed for more than 10 feet lift. The water is pumped from streams where these are available, but a great many take water from wells, from 15 to 50 feet in depth. More than 2000 wells are thus used for the

irrigation of rice in Louisiana and Texas, the motive power being usually steam in Louisiana, while gasoline is frequently employed in Texas. These two States produce over three-quarters of the rice produced in the United States, most of the rest being grown in Arkansas and California. Over 90 per cent of this is irrigated by pumping, and this mainly by centrifugal pumps.

According to Gregory, the largest irrigation pumping plant in the rice country is that of the Neches Canal near Beaumont, Texas, which has a capacity of about 440 cubic feet per second, pumping against a head of 30 to 35 feet. This is accomplished by six rotary chamber wheel pumps. These pumps have shown good efficiency and reliability, but some plants of this type have given considerable trouble. One complication is the irregular discharge velocity, making it necessary to provide air chambers near the pump. This and other characteristics require a higher grade of skill in their operation and maintenance than is necessary for the centrifugal pump.

REFERENCES FOR CHAPTER VII

- MURPHY, E. C. The Windmill, Its Efficiency and Economic Use. W. S. P. 41 and 42, U. S. Geological Survey.
- GREGORY, W. B. Evolution of Low-lift Pumping Plants in Gulf Coast Country. American Soc. Mechanical Engineers, New York.
- DAVIS, A. P. Irrigation Works Constructed by United States. John Wiley & Sons, New York.
- ETCHEVERRY, B. A. Use of Irrigation Water. McGraw-Hill Book Company, New York.
- FLEMING, B. P. Practical Irrigation and Pumping. John Wiley & Sons, New York.
- TAIT, C. E. Use of Underground Water for Irrigation, at Pomona, Cal. Bulletin No. 236, U. S. Office of Experiment Stations.
- MAHAN, F. A. Water Wheels. E. & F. Spon, New York.
- SCHLICHTER & WOLF. Underflow of South Platte Valley. W. S. P. No. 184, U. S. Geological Survey.
- NEWELL & MURPHY. Principles of Irrigation Engineering. McGraw-Hill Book Company, New York.
- O'SHAUGHNESSY, M. M. Irrigation Works in Hawaiian Islands. *Engineering News*, April 15, 1909.
- WILSON, HERBERT M. Pumping Water for Irrigation. W. S. P. No. 1, U. S. Geological Survey.
- HUMPHREY, H. A. Direct-Acting Explosion Pump. *Engineering News*, Dec. 2, 1909.

CHAPTER VIII

IRRIGABLE LANDS

ONE of the first and most important fundamentals to determine regarding a proposed irrigation project, is the area and character of the irrigable land. Simple as this may seem, it is a frequent cause of failure of such projects, that only cursory attention was given this important element in planning the projects.

1. **Topography.**—For successful irrigation the land should have some slope in order that the water may be induced to run over it in gravity canals and farm ditches. When the water in a canal is quiescent, and no current can be detected, its surface is level, or practically so, and in order to induce a flow, a considerable slope must be given its surface. Sometimes an extensive plain, perhaps an ancient lake bed, is so flat that it furnishes no considerable slope in any direction on which to build a canal with natural slope sufficient to carry the irrigation water. This water must therefore be provided at the edge of the plain at sufficient elevation so that by confining it between dikes it can be held above the level of the land with its surface gently sloping in the direction of flow, and must reach each field to be irrigated with the water surface sufficiently above ground so that it can be induced to run over the fields to be irrigated. If the distance through which the canal must be thus carried is great, the height of the dikes forming the elevated water way may be too expensive, and their maintenance too precarious to be feasible. In general, extensive tracts of this nature are not numerous, and when small, they can be treated as above indicated; but owing to lack of grade the canals must have small slope and low velocity.

The desirable slope of the irrigable land is between 10 feet per mile and 30 feet per mile in the direction of greatest slope. Less than the lower limit mentioned involves some inconvenience in getting water over the fields, and in disposing of waste water, while more than 30 feet may involve extra expense in providing drops in canals, or other devices to avoid destructive velocities. A typical valley usually has a slope parallel with its drainage



FIG. 24.—Shoshone Desert before Irrigation.

line and approximately equal thereto, and also a slope from the hills normal to the stream.

While the above limits indicate the convenient slopes, the feasibility of irrigation is not thus limited by any means. Water can be successfully applied where the slope is little or nothing, and also on side hills so steep that plowing and other farm operations are difficult; but such conditions require special devices and expenditures, and great care in the application of

water. In countries where land and its products are of low value, a limit of slope of 10 per cent is sometimes adopted, and land with greater slope than this is classed as non-irrigable. Where land values are higher, however, a greater slope can be tolerated and successfully irrigated, by the use of small heads of water and by handling it with care.

While the ideal plain for irrigation is a smooth gentle slope, this is seldom encountered in practice, and the country to be



FIG. 25.—Shoshone Desert after Irrigation.

irrigated may be rolling and traversed with drainage lines. If these are very large or frequent, they will greatly increase the cost of the system by the necessity of providing structures for drainage crossings. If the natural drainage lines are not too large or numerous, they may be advantageous in furnishing natural escapes for storm and waste waters.

2. Soil Survey.—The fertility of the soil must, of course, be beyond doubt. In any country, except an extremely arid one, the fertility of the soil may be partly inferred from the

character of the natural vegetation. In general the growth of thrifty sage brush is an excellent indication, as this does not thrive on poor soil nor on that impregnated to a harmful extent with alkali. In some cases, however, sage brush land with soil otherwise excellent may be dotted with frequent spots of rock having enough soil on the surface and in crevices and pockets to produce a fair growth of sage brush, but unfit for profitable cultivation. Care should be taken to ascertain that all the land classed as irrigable has at least 2 or 3 feet of soil over any rock or hardpan that may underlie it.

The presence of greasewood generally denotes that for some reason the conditions are not favorable for sage brush, unless some of the latter also occurs. Frequently, the reason is a heavy soil, or the presence of alkali in too great an amount for sage brush.

The freedom of the passage of water through sand is fairly good assurance that sandy soil contains no injurious amounts of alkali, and this is generally true.

Unless the character of vegetation carried by a tract, or the sandy nature of the soil is such as to assure the absence of harmful amounts of alkaline salts, it will be well to have a soil survey made to determine the depth and character of the soil.

Soil samples at varying depths may best be obtained by means of a soil auger, which can be made by any blacksmith. It should be about 2 inches in diameter, and should have a shaft that can be extended to a total length of 5 feet, so that if desired samples at that depth can be obtained. The samples obtained should be kept separate and carefully labeled as to locality and depth at which obtained. All samples should be tested as to total soluble salts. At least 10 per cent of the samples taken at each foot of depth should be quantitatively analyzed for carbonate, bicarbonate, chloride and sulphate of sodium, and sulphate of magnesium, and at least 10 per cent of the remaining samples should be subjected to simple tests to show whether the indications of the analyses are safe guides, and which salt predominates. The number of samples taken must

depend upon the degree of doubt existing as to the quality of the soil, and should be determined as the inquiry progresses. If the results are fairly uniform, fewer samples are necessary than if they vary greatly. If little alkali is found, fewer samples are necessary than if the alkali is so abundant as to stimulate doubt of the arability of the soil.

Sandy areas are sometimes so rough as to be expensive in leveling. There is often a tendency for the sand to drift about desert shrubs, and if the dunes or hummocks are numerous they may occupy too much room to permit farming between them, and the cost of leveling them may be prohibitive. Even land that to the casual observer appears smooth often requires considerable leveling for proper irrigation. Otherwise, the water applied will seek the low places, and soak them too heavily, while the high points are left dry. Neglect to properly level the ground is one of the commonest failings of agriculture under irrigation. It often happens that depressions or sinks occur which in their natural state may be rather more fertile than the surrounding land, but that owing to lack of surface drainage are likely under irrigation to become ponds or bogs, too wet to cultivate. It may be possible to provide drainage, but the cost of this must be considered, and if prohibitive the areas must be eliminated.

All areas found to be non-irrigable or of doubtful fertility must be liberally measured and carefully eliminated from the irrigable area, and the extra length of canals and laterals necessary to reach a given area must be liberally allowed for. Allowance must also be made for the ground to be occupied by roads, canals, railroads, drainage lines, and any other areas that cannot be actually cultivated.

Consideration must be given to the cost of clearing the land. If heavily timbered, under circumstances in which the timber cannot be marketed, the cost of clearing plus the cost of irrigation may nearly equal or even exceed the value of the cleared land. The cost of clearing smaller brush may often be an important element in considering the feasibility of the project.

3. **Preparation of Land for Irrigation.**—*a. Clearing.*—In the preparation of raw land for irrigation, the first step is the removal from the surface of the native vegetation. If this is simply a sod of grass, rabbit brush or other small vegetation, it may be plowed under, by means of a strong team attached to a breaking plow, and this when possible, is very desirable, as this retains the vegetable matter in the soil where by decay it forms valuable plant food, generally much needed. But if the ground is wholly or partially covered with larger shrubs or trees, these must be removed or burned.

Sagebrush and Greasewood.—The commonest grade of clearing required is sagebrush, greasewood, creosote brush, and other shrubs too large to plow under, and too coarse and woody to decay readily. In many cases such brush is worth saving for fuel, or for riprapping sandy banks to prevent erosion by wind or water. These shrubs cover a large proportion of the irrigable lands in the Rocky Mountain and Pacific States, and usually range from 3 to 6 feet in height. They may be easily broken off at the ground surface by means of a device formed of three railroad rails, with the heads interlocked, and firmly bolted together, leaving the flanges projecting, so as to form dull edges. This device may be dragged across the brush by eight horses and is very effective in breaking down the brush, which may then be easily collected, and either burned or piled for future use. Sagebrush when not very large is sometimes plowed out by heavy teams or traction engines, and as the plowing is often desirable, the method is a good one, although more expensive than the rail method, which has been done for \$2.50 to \$3.50 per acre, while the plowing method costs from \$1.00 to \$2.00 more. The roots of these shrubs give little trouble in tillage, and soon decay.

Mesquite is an abundant native of the Southwest, is larger and tougher than sagebrush and has much heavier stumps and roots. It is commonly removed by hand, and makes excellent firewood, and trunks of sufficient size and straightness are used as fence posts. The stumps and roots do not decay rapidly and are generally grubbed by hand, which is laborious and expensive.

Juniper and Pinon trees are numerous in middle latitudes and altitudes, and merchantable pine trees sometimes occur on land destined for irrigation. The long leaf pines may furnish saw logs of value, but the Pinon is of value only for fuel.

Juniper (sometimes called cedar) often sends many heavy branches from one root at the ground, and all these must be cut. The stumps do not readily decay, and are difficult to grub. The cost of clearing is therefore greater than in the case of pines. Juniper is much used for fence posts, which are very durable.

Where the soil is sandy and likely to blow when the brush covering is removed, the clearing must be performed with great care and caution. It should never be attempted in the spring or at any season when high winds are to be expected. In most localities late summer is the best season in this respect. Not all of the ground should be cleared in one season, but where the topography will permit the land should be divided into strips about 40 feet wide, and only alternate strips cleared, the brush being left on the intervening strips as a protection against wind. As soon as cleared, each strip should be leveled as quickly as possible, and immediately irrigated and seeded. Rye or wheat are good crops to seed first, as they sprout and cover the ground quickly, grow late in the fall, and start early in the spring. If possible, immediately after seeding a liberal sprinkling of straw should be spread over the ground and a disk harrow run over it, with the disks vertical. This will force the straw partly into the ground, leaving the ends sticking up like a stubble. This will tend to prevent drifting until the grain can cover the ground.

Alfalfa may be seeded at the same time, and the rye or wheat then serves as a nurse crop, to protect against drifting, and by the time the grain matures the alfalfa should be large enough to care for itself. One year later than the first seeding the intervening strip on which the brush was left may be cleared, leveled and seeded in the same way. Water must be used rather freely the first year or two, and means should be provided for using this in large heads, so that it may be run over the ground quickly, before that first applied sinks below the root zone. In such sandy regions it is well to cover the ditch banks,

roadsides, and all other unoccupied areas, with vegetation of some kind to prevent drifting of the sand. Rye is excellent for this purpose, as it stands drought well, reseeds itself, and never becomes a pest. Alfalfa serves the purpose even better than rye, but requires more water, especially in youth. As soon as a good stand of alfalfa is secured, no further trouble need be encountered with that particular land, but it may still be subject to danger from the drifting of sand from neighboring fields. One or two ignorant, careless or unskillful farmers can cause their neighbors immense damage by clearing and plowing their land and leaving the soil to drift, filling laterals and roads, and covering other fields with unwelcome sand dunes. No



FIG. 26.—Slip Scraper.

legal remedy has been provided for such offenses, and it is necessary to give timely expert advice and exert all possible moral pressure to see that the advice is carefully followed.

The cost of clearing mesquite, pines, juniper, cottonwood, etc., varies widely with the size and density of the growth, and the thoroughness with which it is done. Where the growth is small and sparse, and grubbing is unnecessary, as on arid benches, mesquite and pinon may sometimes be removed for \$10 per acre, while the heavy timber may run in some cases considerably above \$100 per acre. While some use can usually be made of the wood, its value rarely approaches the cost of clearing, and is generally but a small percentage thereof.

b. Leveling.—It is seldom that in its natural state irrigable land has an entirely smooth and even surface, and though to the unpracticed eye it may appear smooth, it generally has undulations, which, however slight, interfere with the even application of irrigation water. In attempting to irrigate such land without leveling, the farmer will find that the water tends to accumulate in the depressions and over-irrigate them, while the elevated spots receive little or no water. Much labor is expended in trying to secure uniform distribution of the water, and the results are not satisfactory. Failure to properly level the land is one of the commonest errors of beginners under irrigation, and is often fatal to success.

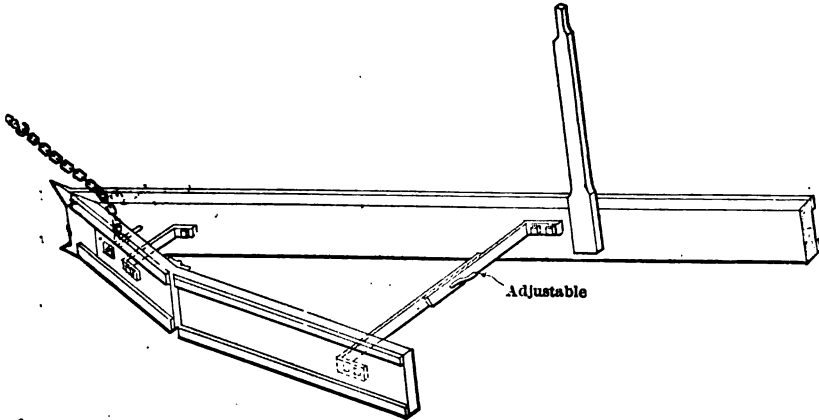

FIG. 27.—Adjustable V for Making Head Ditches.

It is not desirable to make the land a dead level, but to give it generally a smooth plane surface with slopes either uniform or varying to suit the mode of irrigation adopted. If the natural slope is considerable, and the furrow method of irrigation is to be used, perfect smoothness is not so important as with other methods of irrigation, but is still desirable.

Apparent smoothness sometimes leads the farmer to believe that no leveling is necessary, but this is seldom the case. More frequently the cost of proper leveling is the most important item in the preparation of the land for irrigation, and it is a

mistake to plant orchards, alfalfa or other perennials until this is thoroughly done, or to plant any crop without a fair degree of leveling. If any great amount of leveling is necessary, the mounds must be scraped off and the soil used to fill the hollows, and after a year of irrigation, it may be found that the new ground has settled, and further work must be done to achieve satisfactory results. For this reason, it is often best to plant



FIG. 28.—Leveling New Land. Idaho.

some annual crop, as grain, or still better a row crop like beans, on which the furrow method of irrigation can be used.

The amount and character of leveling required varies somewhat with the method of irrigation proposed. The furrow method can be used with less careful leveling than any of the flooding methods, provided the slope is ample to force the water through the furrows, and provided some pains are taken to make the bottom of the furrow more uniform in slope than the ground surface, by deepening the furrow across mounds, and making it shallower across depressions.

When the border system is used, the ground between borders should have a uniform slope parallel to the borders, and perfectly level transverse thereto. This will make each border a miniature terrace, to correspond to the slope of the head ditch, and will minimize the labor of irrigation. If the check system is to be used it will result in miniature terraces in both directions. It will be seen that it is important to have in mind the system to be used, before the leveling is done.

The scraping down of mounds and the filling of hollows is best accomplished with the Fresno scraper, shown in Fig. 29. Its adjustments are such that it may be made to take off a

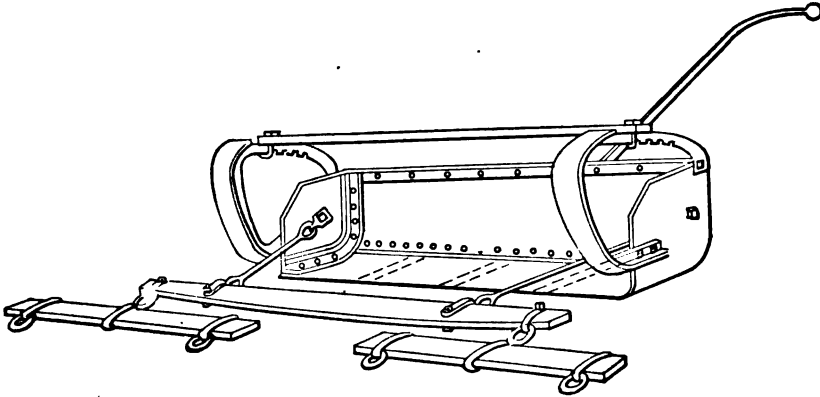

FIG. 29.—Fresno Scraper.

thick or thin coat of earth, and in dumping the load, it can be made to spread the earth in as thin a layer as desired, and to leave it fairly level. These are important advantages peculiar to this implement. The Fresno can be used for hauls of any distance, but it is not very advantageous for long hauls. It is also suitable for making ditches, dikes, and any other scraper work where the haul is not great enough to require wheels. The final leveling may be accomplished by a cheap device called a "float," drawn by three or four horses. (Fig. 30.)

Where the leveling is merely local and no haul required, the ordinary road machine on four wheels carrying an adjustable blade is sometimes used, and is very useful where available.

The cost of leveling varies from a few cents per acre to the maximum amount that can be afforded, and depends on the amount of dirt and the distance it has to be moved. In some localities the cost of leveling determines whether land is irrigable or non-irrigable, and cases occur where from \$60 to \$75 per acre is spent on leveling alone. On steep hillsides successful irrigation may require the surface to be graded into terraces, and in Southern California several hundred dollars per acre is sometimes spent on such preparation.

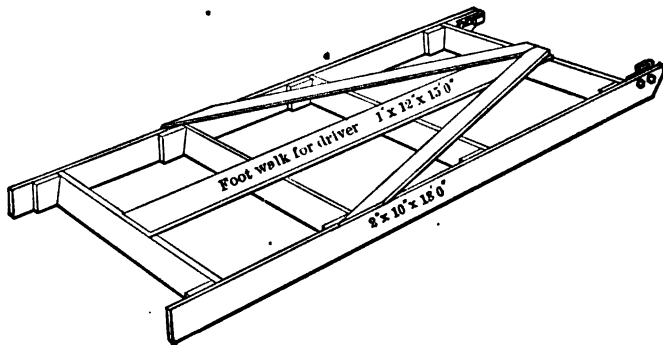

FIG. 30.—Float for Leveling Irrigable Lands.

c. Ditching.—Farm laterals must be provided to lead the water from the irrigation system to the high point or points on the farm, and a head-ditch must be provided to conduct the water along the upper edge of each field. Then if the check or border methods of irrigation are to be used, it will be necessary to provide the levees needed. Some work on the larger laterals may be done by means of the slip scraper, illustrated in Fig. 26, but most of it can best be performed with a plow and a *V* or crowder, which is a wooden *A*-frame, shod with iron and steel drawn by two or three horses. It can be easily made on the farm of standard materials found in any town, and is very useful not only in irrigation, but for road grading as well. See Fig. 27.

CHAPTER IX

APPLICATION OF WATER TO THE LAND

IN A few cases, under special conditions water is applied to plants through pipes, by sprinkling or otherwise, as in the irrigation of city lawns, and some flower and vegetable or fruit gardens. A few orchards are supplied from subterranean pipes with a spigot at each tree. These methods are expensive and exceptional and are employed only on a relatively small scale. More than 99 per cent of the application of water in irrigation is from open canals and laterals, although the conveyance of water in cement pipes to avoid percolation losses is growing as the value of water increases in various localities under special conditions.

1. Methods of Irrigation.—The usual methods of applying water to land may be divided into two general systems namely: the flooding system and the furrow system. Each of these general systems may in turn be subdivided into two special methods, thereby constituting four methods, more or less distinct, as follows:

1. Free Flooding.
2. Flooding between Borders.
3. Furrow Irrigation.
4. Corrugation Method.

a. Free Flooding.—This method is the earliest and crudest method of applying water. When carelessly employed it is wasteful of water and secures indifferent results, being apt to slight certain parts of the field, and over-saturate other parts; but when applied with skill and care good results can be secured. This system is applied by providing sublaterals on contours across the field on a fall of from 1 to 3 feet per thousand, and leveling the field between these sublaterals. To apply the

water, a temporary dam of wood or canvas is inserted in the ditch, causing it to overflow on the lower side, or to discharge its water through openings in the lower bank; and shovel in hand, the irrigator coaxes the water to all parts of the ground, leading it to the dry places by clearing away obstructions, and checking it with shovels of dirt where it runs too freely. If the field be carefully leveled, the ditches carefully located and constructed, and the irrigator uses sufficient skill, large heads of water may be used, very good results may be obtained and a field may be thus irrigated very quickly.

. In a modification of the free flooding method commonly used on steeper ground than the method just described, a series of dikes on contours are provided roughly parallel to the lateral, and the ground above the dike is leveled so that it can be readily flooded. Another dike below the first facilitates the flooding of a lower level, each dike forming a small terrace. This may be extended down the hill to several levels, the water being drawn from one level to the next lower through a pipe or tile, or carried down in a small sublateral. This system merges into the terrace system common in hilly countries, especially in India and China, and to a limited extent in Southern California.

b. Flooding between Borders.—In this system parallel dikes are provided running nearly normal to the farm laterals, generally down the steepest slope of the field, which, however, should not exceed 4 or 5 feet per thousand. These dikes, usually called "borders" are from 40 to 60 feet apart, and 5 to 8 inches high, with gentle side slopes, forming gentle undulations over which machinery can pass with ease. The border should not be more than 400 or 500 feet long, to the next cross lateral below, and in flat country may be from 200 to 300 feet. The steeper the slope, the longer and narrower may be each "land," or "strip."

To apply the water the lateral is obstructed by a temporary dam at the second "border" at the top of the field, causing the lateral to overflow uniformly between the first and second borders. If the ground is properly leveled and an ample head is used, the water flows slowly and uniformly several inches deep between these borders as in a broad shallow canal to

the lower end of the strip. When a sufficient amount of water has been turned on to the strip to thoroughly wet it to the lower end, the temporary dam is removed from the head of the



FIG. 31.—Using Canvas Dam.

second border, and placed in the lateral at the head of the third border, causing the lateral to overflow between the second and third borders, and this process is repeated across the field.

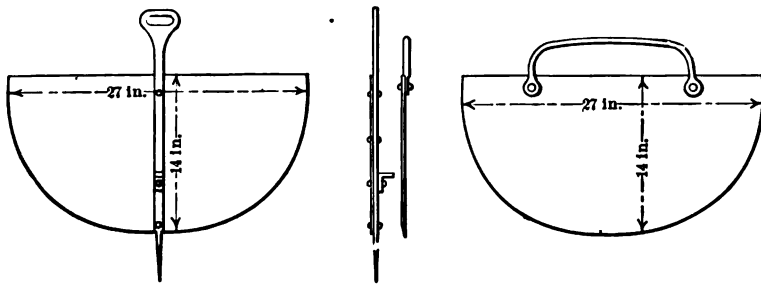

FIG. 32.—Steel Dams.

Experience will soon teach the irrigator to judge closely when enough water is started down the strip to accomplish its mission without the waste of much water, or the over-irrigation of any

part of the strip. Skillfully employed, with large heads of water, land properly leveled, and laterals properly constructed, this method secures good results, and is the most expeditious of all the methods here described, provided the topography and slope are favorable.

To secure good results economically, this system requires careful and thorough preparation of the field. There should be no side slope between the borders, so there will be no tendency



FIG. 33.—Diverting Water from Head Ditch by Canvas Dam, Shoshone Valley, Wyoming.

of the water toward one side of the strip. Provision should always be made so that the waste water at the lower end of the strip shall be received into the next cross lateral and utilized in irrigating the lower lands. The strip should be of such length, and the head of water used of such volume that the water will reach the lower end of the strip before much water has time to waste into the subsoil on the upper end where it is turned on. Thus the details must be worked out with reference to the character of the soil, the slope, and the head of water available.

The border system is especially recommended for the irrigation of open sandy soils, because it is the system best adapted to the safe and economical use of large irrigating heads. If small quantities of water are turned on very loose sandy soils, the rapid downward movement absorbs so much water that little is left to flow to the lower end of the field, and it moves along the ground so slowly that the major portion of the water is lost by dropping below the plant roots. A larger quantity applied



FIG. 34.—Drawing Water from Head Ditch through Small Pipes, Riverside, California.

to the same ground percolates downward as fast but no faster, but by its volume, moves rapidly over the field, and the irrigation is accomplished before much water is lost, provided the ground is well prepared and the irrigation performed with skill. Previous preparation, however, is very important.

Experiments on sandy land near Hermiston, Oregon, in the Umatilla, Valley illustrate this fact: Two tracts of land of the same size on similar soil were irrigated by the same man, using



FIG. 35.—Field Prepared for Irrigation by Checks.



FIG. 36.—Border Irrigation in Nevada.

a head of $3\frac{1}{8}$ cubic feet of water per second. To the first plot 3.5 inches of water was applied in one hour, and it was well irrigated. To the second tract 16.8 was applied, which required $4\frac{3}{4}$ hours of labor, to accomplish the irrigation. The first field was bordered and well leveled, with turnouts of good size. The second field was irrigated by free floodings, and had not been properly leveled. Its irrigation cost for labor and water, $4\frac{3}{4}$ times as much as the first field, and the results were not so good.

c. Furrow Irrigation.—

This system is specially adapted to the irrigation of crops growing in rows, though it can be also applied to others. It provides for turning the water into furrows which run across the field in the direction of greatest slope unless this is excessive, in which case they should follow the grade on which a furrow full of water will run freely without erosion. The furrows should be from 2 to 4 feet apart, depending upon the slope and the nature of the soil. If the slope is steep and the soil relatively tight, they must be closer than under the reverse conditions, as the subsurface of the ground between the furrows must all be thoroughly wetted by the time the irrigation is completed. The water is allowed to run in each furrow until there is sufficient to run through to the lower end, which is generally a distance of 200 to 400 feet to the next cross ditch.

Furrow irrigation is better adapted than the flooding methods

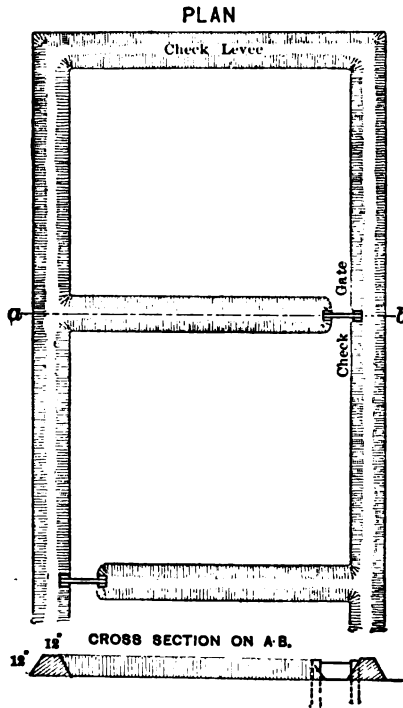

FIG. 37.—Diagram Illustrating Flooding in Rectangular Block. Cowgill.

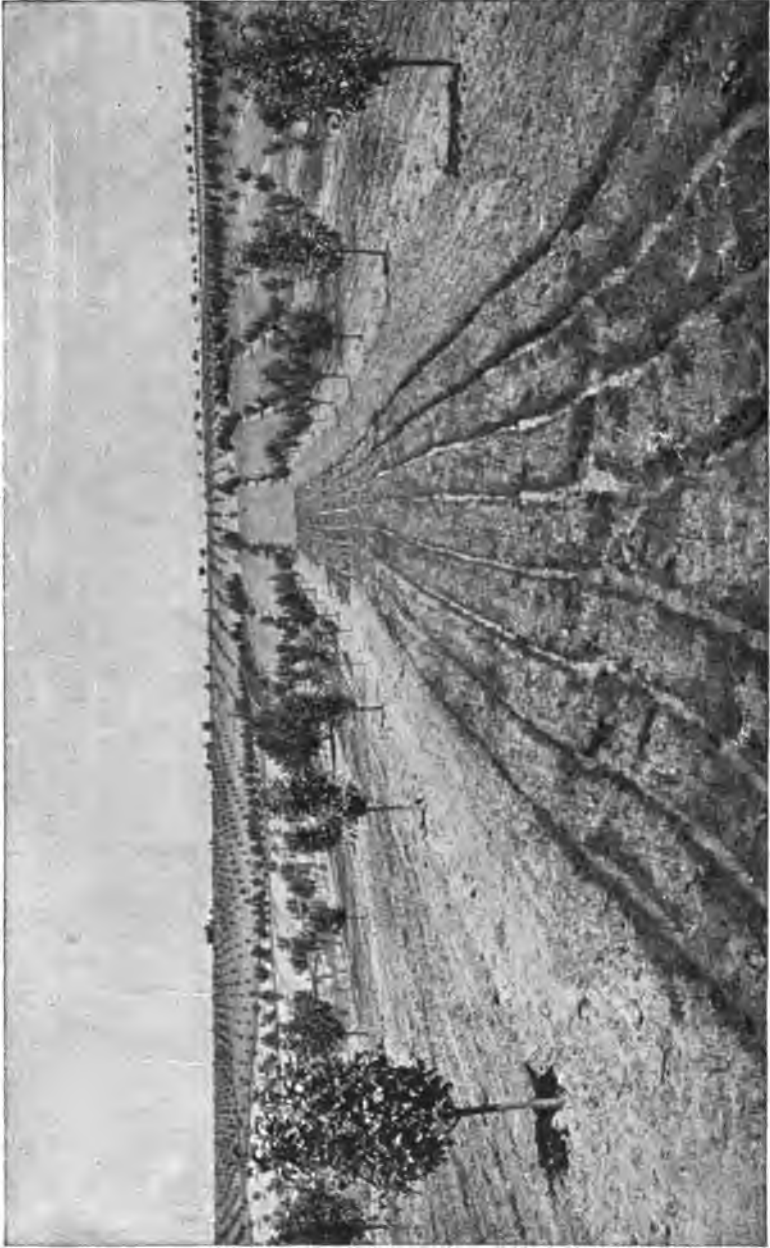

FIG. 38.—Orchard Irrigation by Furrow Method, Yakima Valley, Washington.

to undulating fields and steep slopes, upon which the furrows can follow such lines as will secure the most desirable grades. It also secures a thorough wetting of the root systems of the crops, without wetting the top of the ground except in the furrows and thus to some extent avoids baking. It has a tendency to encourage deep rooting and does not promote shallow rooting as do flooding methods of application. After furrow irrigation



FIG. 39.—Furrow Irrigation of Cabbages, Yuma, Arizona.

it is practicable to get over the ground sooner with a cultivator, which is very desirable. For these reasons if skillfully used it is more economical of water than the flooding methods. The size and length of the furrows will depend upon the soil and slope, the closer soils and steeper slopes permitting longer furrows between cross laterals.

d. Corrugation System.—This is a modification of the furrow system that combines some of the features of the flooding methods also. It is generally an adaptation of furrow irriga-

tion to crops not planted in rows, such as grain and alfalfa, and is more applicable to rolling topography than the flooding methods proper.

After proper leveling of the minor inequalities of the surface, usually immediately after planting, while the ground is soft, a series of parallel grooves are made with a machine constructed for the purpose, resembling a short wide sled with several runners, each of which makes a groove in the soft ground,



FIG. 40.—Furrow Irrigation on Terraced Hillside, California.

several inches in depth, from 2 to 3 feet apart, depending on the soil and slope, the closer spacing being required by tight soil and steep slope. The grooves are longitudinally given a gentle grade, so as to conduct the water gently along in the direction required, and prevent it running down the steepest slope, so as to avoid erosion.

e. Leveling.—All these methods of applying water to land require thorough and careful preparation for the best results, especially the leveling of the surface inequalities.

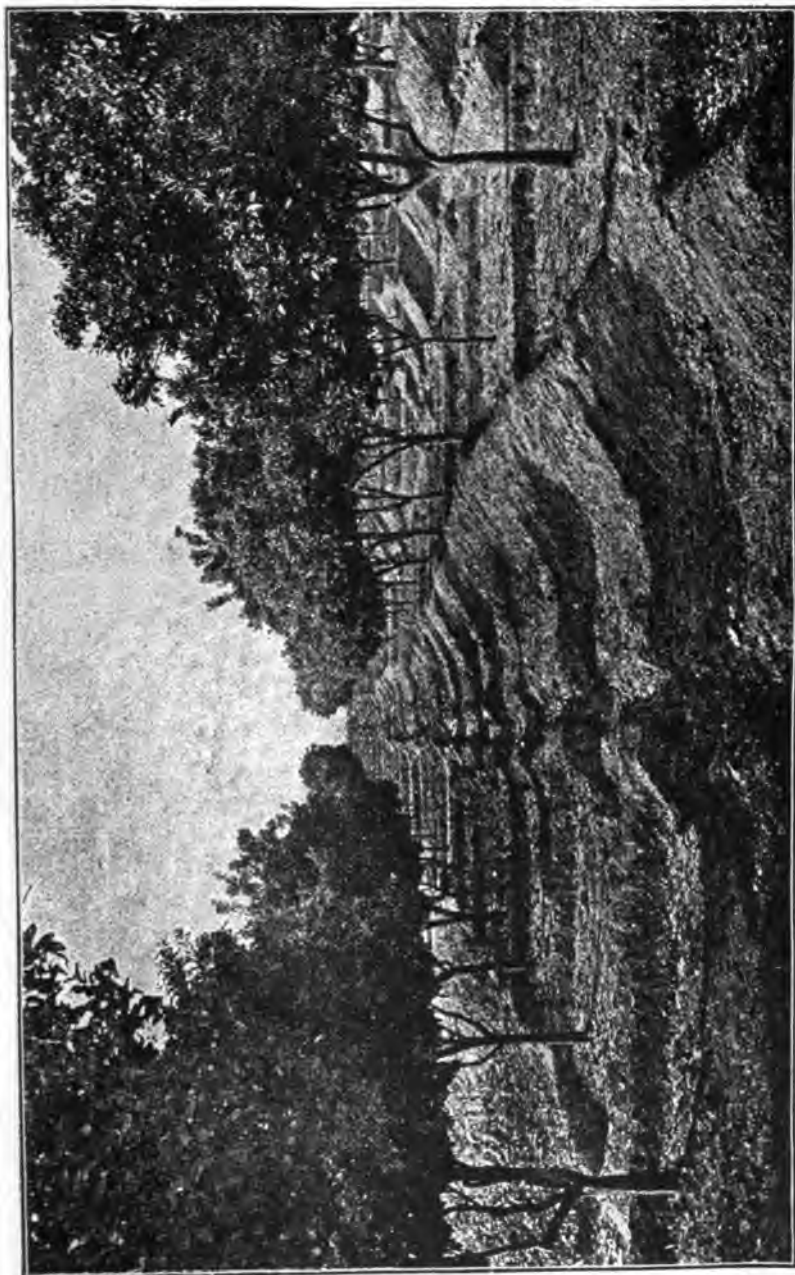

FIG. 41.—Irrigating Orchard by Terraced Basins on Hillside.



FIG. 42.—Orange Trees Irrigated by Check System, Salt River Valley, Arizona.



FIG. 43.—Furrow Irrigation of Orange Grove, Riverside, California.

2. Sewage Disposal.—One of the most important and difficult problems with which municipal engineers have to deal in that of sewage disposal. In the humid regions where

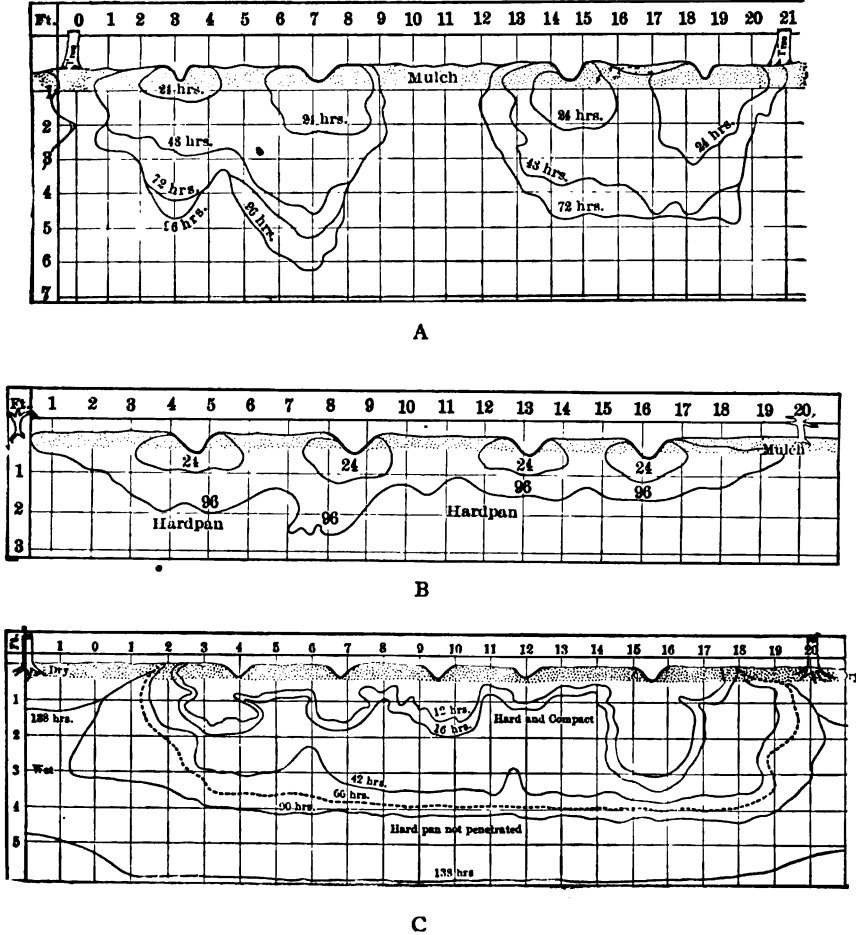

FIG. 44.—Extent of Percolation from Small Furrows: A, in Loose Loam; B, in Hardpan; C, in Impervious Grit.

the large cities are usually found very close to rivers of some magnitude or near the ocean, the sewage has usually been disposed of by discharging it into the natural waterways and allowing it to be carried off to the ocean, more or less of the im-



FIG. 45.—Irrigating with Large Head by Border Method from Cement Head Ditch, Salt River Valley, Arizona.



FIG. 46.—Irrigating Corn with Sewage, Plainfield, New Jersey.



FIG. 47.—Furrow Irrigation of Apple Orchard, Idaho.

purity being removed first, in many cases. In the arid regions, this method of disposing is not so easy of accomplishment, because of the lack of waterways into which to discharge it. Difficulties have also been encountered in the older inhabited portions of the country, because of the large amounts of sewage contributed by the dense population at short intervals along the waterways carrying small quantities of water.

Because of the difficulties of disposing of sewage by dilution just referred to, and in some cases with the idea of utilizing the fertilizing properties of sewage, other methods of disposing of sewage have been employed, most of them recently developed. However, the use of sewage for irrigating land has been employed for centuries. The sewage of Edinburgh has been so used for an unknown number of years, certainly several hundred, and in the Craigentny meadows, originally a waste of sand dunes, 250 acres irrigated with sewage have been yielding crops of hay and Italian rye grass for one hundred and fifty years. In 1858 the first scientific investigation of this use of sewage was made in England, and a number of English towns began to construct sewage farms. One of the areas was at Aldershot, constructed in 1864, where the sewage of 20,000 people is used for irrigating about 120 acres. The soil here is coarse sand with a very fine sand subsoil.

In this country irrigation was employed in a number of Eastern cities shortly after 1870, but has been practically abandoned in the Eastern States. On the other hand, it has been increasing in arid sections of Western ones. At the present time (1918) there are known to be thirty cities and towns in California that dispose of their sewage by irrigation, one in Arizona, one in Kansas, two in Oregon, and three in Montana. In the Eastern States there are believed to be only eighteen cities or towns where sewage irrigation is practiced, three in Connecticut, one in Massachusetts, one in New York, nine in New Jersey, two in Pennsylvania, and two in Virginia.

A process very similar to irrigation is used for disposing of sewage known as "intermittent filtration"; in fact, it is difficult to draw the line sharply between the two. In inter-

mittent filtration the sewage is run over the land for a short period and then the flooding ceases while the land absorbs and digests the sewage already received; then, after a brief rest, the same land is again flooded. Ordinarily no crops are grown upon such land, but the top soil is kept loose so as to more readily absorb the sewage. In intermittent filtration the controlling purpose is to dispose of the sewage in a sanitary manner and to produce an acceptable effluent; in the case of irrigation or sewage farming, on the other hand, the controlling purpose is to utilize the sewage to the best advantage in raising crops, purification of the sewage being a secondary purpose.

3. Sewage Irrigation.—The utilization of sewage by broad irrigation requires the employment of a much larger tract than for intermittent filtration, one acre of land being sufficient to utilize the sewage of from 50 to 200 people, while intermittent filtration on favorable soil the sewage from 500 to 1500 people per acre can be purified. If it is desired to use more sewage in irrigation than that named above, this is possible, but generally only at some sacrifice to the best results from the crops.

The water returned by the soil to the natural drainage channels is pure enough to be harmless for any purpose, except for human consumption, wherever all of the sewage passes through the soil; although, of course, if any of it runs over the surface into the drainage channel, such purification is not obtained. One of the most serious objections to the disposal of sewage by irrigation is the fact that the farmer must take the sewage at all times, even though he has more than he wants and it injures his land, unless it be possible for him to waste the sewage directly into drainage channels. It has been found, however, that a combination of the above methods, in which intermittent filtration is used as a supplement to broad irrigation, practically overcomes this advantage and is the most satisfactory method of disposing of and utilizing sewage on land. This is done by laying out a small portion of the land as a filter bed, and discharging the sewage onto this at such times as it is not needed in irrigation. Where this plan is practiced it is necessary to turn the sewage onto the filter beds for a few

hours at a time, about once a week, in order to keep alive in the soil the purifying bacteria.

Irrigation in America has been practiced in two ways, by broad irrigation and by subsurface irrigation; most instances of the latter use having occurred in the Eastern States.

4. The Fertilizing Effects of Sewage.—Sewage used for irrigating acts in two ways—supplying water to the soil, as in the case of water irrigation; and, besides, contributing fertilizing matter to the soil. Sewage contains varying amounts of nitrogen, potash and phosphates, different authorities calculating that the amount of such chemicals in 1,000,000 gallons of sewage would have a theoretical value of from \$40 to \$125. Some of these constituents, however, may be only partly available for manurial purposes, or may be carried on beyond the reach of growing crops by the water that is drained from the soil. Others may be retained at or near the surface and later penetrate the soil very slowly if at all. Sewage generally contains more or less grease, which tends to clog the pores of the soil, and also filaments of cloth and paper, match sticks and other insoluble materials that collect on the surface and form a sort of mat. These may be dug under, but doing so is of doubtful value.

Experience on European sewage farms, notably at Paris and Berlin, appears to indicate that farmers are willing to pay more for land irrigated with sewage than for that which is not. In this country, the conclusion seems to have been generally reached that sewage is of little if any more value for irrigating than is plain water, but on the other hand, it is not considered to be less valuable; and in arid districts where water is needed for irrigating and where sewage can be used for this purpose at no greater expense than that required for obtaining other water, irrigation with sewage is being adopted more and more generally. One of the latest towns to take up sewage irrigation was Tucson, Arizona, where, after using sewage in this way on a small scale for seventeen years, arrangement was made in 1918 to irrigate 483 acres of farm land with the sewage of the city, for which the city is receiving about \$10 per acre per year.

All kinds of vegetables, grains, and trees that are raised

by irrigation can be grown on sewage farms; but lettuce, radishes, berries and other edible vegetable products that are eaten raw and could in any way come in contact with the sewage should not be grown on such farms because of the danger that germs in the sewage might cause typhoid fever in the consumers of the products of the farm. An epidemic of sixty-three cases of typhoid fever at a Massachusetts insane asylum was traced to celery fertilized by sewage. On the Paris farm the cultivation of strawberries, salad crops and other vegetable products that are freely exposed to the sewage and then eaten raw is prohibited.

5. Effects of Sewage Irrigation on Health.—Fears are sometimes expressed that sewage farms would be dangerous to the health of the neighboring districts and that crops grown on them would be unwholesome. These fears, aside from the danger of direct contact with the edible parts of vegetables referred to above, have proven groundless and sewage farming, while it satisfies the sanitary conditions, at the same time gains for agriculture a source of fertilizer as well as of water which would otherwise run to waste. The crops themselves, in utilizing the sewage, transform all of the dangerous and objectionable matters, just as they do in utilizing manure and other fertilizing materials. There is therefore no danger from sewage matters absorbed by the plants.

It has been quite fully demonstrated that there is no danger to health in any odors, gases, or vapors that may arise from sewage on a sewer farm. It is conceivable that disease germs might be carried from the sewage by flies or other insects, but experience indicates that such danger is very slight, there being no cases on record of disease which has been communicated in this way. As to sewage matters which may be deposited on the surface of the soil, thorough tilling of the soil after each flowing of sewage is essential, and it is by the creation of a proper tilth that the aeration of the sewage and incorporation of the solid matter with the soil is accomplished. This prevents the accumulation of sewage matters on the surface and furthermore any danger to the salubrity of the surrounding country.

When sewage is run on the land, there is at times a perceptible and faintly disagreeable odor, especially under certain atmospheric conditions, but this odor is not perceptible more than a few hundred feet away, and as soon as the soil has been cultivated it entirely disappears.

6. Duty of Sewage.—At Pasadena, California, the sewage of 6000 people is used in irrigating about 40 acres of the land, or about 1 acre to each 150 inhabitants. At Los Angeles (previous to the abandonment of the farm and the carrying of the sewage to the Pacific, due to the spread of the city over the land available for irrigation) the entire sewage, which averaged 105 second-feet flowing constantly, was used in irrigating 17 acres. This is the sewage of 50,000 people and it was therefore employed at the rate of about 30 individuals per acre; also at the rate of about 40 acre-feet per acre per annum. On the average, possibly, western irrigated land uses during the irrigation season about 10,000 gallons per acre per day, or the sewage of about 80 persons per acre.

Prof. Wilson has stated that with few exceptions the irrigating duty of sewage is less than that obtainable with clear water, raw sewage seldom serving more than one-third to one-half as much area as the same quantity of clear water, owing to the surface of the soil being clogged by the solids in the sewage, which causes much of the water to run off without soaking in. This disadvantage can be removed to a considerable extent by previously clarifying the sewage, removing all of the coarse suspended matter. The objectionable reduction of duty by clogging may not interfere with the use upon the land of as much sewage as is desired for crop irrigation, but this limitation may become objectionable only when the problem is one of disposing of sewage on the minimum amount of land.

7. Methods of Laying Out Sewage Farms and Applying Sewage.—In preparing land for sewage irrigation it must be remembered that the sewage cannot be disposed of continuously on the same piece of land with benefit to crops, but that it must be rotated from one plot to another so as to give each a rest and permit of the soil being cultivated and the crops handled.

With this end in view, it has been found that the most satisfactory way of laying out a sewage farm is to divide it into many very small tracts or plots of about one acre in extent each, so arranged and subdivided by distributing channels that the sewage may be applied to them separately and independently. Experience has shown that first of all the soil must be of suitable texture, and care should be taken to choose a location in which may be found a deep and light surface soil, underlain if possible by a deep and porous subsoil, preferably of sand and gravel. If the slopes of these are such as to furnish good natural drainage, no difficulty is likely to arise in utilizing such land for a definite period of time under proper treatment.

After a suitable soil has been chosen and the land has been under drained or otherwise suitably prepared, it should be divided by open drains, preferably lined, into plots of from 200 to 400 feet on a side. The sewage should be brought to the limits of the farm in closed sewer conduits, which must be properly ventilated. It is desirable at the outlet of the conduit at the entrance of the farm to construct a small storage reservoir, suitably lined, since it may be necessary to retain the sewage for at least twenty-four hours, and certainly over a night, at times when it is not possible to use it. There should also be, at the entrance to the farm, a coarse screen to keep out the larger matters in the sewage; and it is very desirable there should be in addition either a fine screen or a tank adapted in size and shape to secure sedimentation of the suspended matters which would cause the clogging of the surface of the irrigated field. The matters collecting behind the coarse screen may be placed in piles to dry and then burned, and that from the fine screens or settling tank may be removed at intervals and either plowed under the soil or dried and burned. The storage tank and sedimentation tank (these may be combined as one in many cases) are frequently covered to prevent dissemination of odors, but this is not generally necessary unless the sewage reaches the farm in a stale condition, or the tank is so constructed or operated as to permit deposits to collect about it and putrefy.

The most satisfactory way of applying sewage for irrigation is through furrows between rows of vegetables, the simple furrow method of irrigation (page 117) being employed. In some cases, however, the embankment or check method has been employed, more especially in the cultivation of grain and forage crops. After applying sewage to crops it is left only so long as to permit it to become dry enough to work when the land is thoroughly tilled and all solid matter is turned under before the next application of sewage, while such a variety of crops must be employed as to make the irrigation season as long as possible. In irrigating walnut groves on the Pasadena farm, the sewage is allowed to run on one area from four to ten days and is then turned upon another area, the former area being thoroughly cultivated or plowed as soon as it is sufficiently dry to work, which is usually within two or three days. The top soil is plowed under occasionally, but not after each flooding, only a thorough stirring with a cultivator being necessary as a regular treatment.

During the non-irrigating period (the winter months), the sewage may be flooded in rotation over various plots of land and be permitted to filter through this and find its way back to the natural drainage channels. It is desirable, however, to use precaution and not overcharge the land, and this may be prevented by tilling it a few times during the more open days of winter. As soon as the crops are to be sown in spring it is desirable, should too great an accumulation of solid matter appear on the surface, to rake this off or plow it under before planting the season's crops. Ordinarily sewage reaches the irrigated land at a sufficiently high temperature to permit it to remain unfrozen and to find its way by filtration into the soil even during the winter; but in Northern climates this is not always the case, and should the top soil once become frozen it is almost impossible to thaw it again before spring. To prevent this, it is desirable when cold weather is anticipated to plow the farm into furrows about 18 inches apart. This prevents the rapid chilling of the sewage that occurs when it is spread in a thin layer exposed to the air, and should the surface of the sewage freeze, the bottom of the furrow would still remain

unfrozen and would be protected from the freezing air above by the ice that would span the furrow from ridge to ridge.

8. Subirrigation.—The term subirrigation denotes the underground application of water to the roots of plants, as distinguished from its application to the surface of the ground.

There are two radically different methods of accomplishing this result. One is to apply water to a portion of the surface in such quantities as to bring up the ground water to an elevation where it can be reached by the roots of the plants. This is called "bringing up the sub." It is a pernicious practice, very wasteful of water and ruinous to the land. It leaches out the plant food, it waterlogs large areas of land and brings to the surface whatever alkali the soil contains. All these results tend to destroy the fertility of the soil. On the Egin Bench, in the Valley of the North Fork of Snake River in Idaho, the soil is very coarse, and requires frequent irrigation and large quantities of water if surface irrigation is practiced. The water supply is copious in May and June, but the river declines rapidly in July producing a shortage in August. The farmers on this bench have formed a practice of "bringing up the sub." every spring. Water is applied copiously in large ditches and by surface irrigation during May and June, while water is abundant, and after the river has declined the ground water remains high for several weeks, furnishing water for the plant roots for a much longer period than if surface irrigation had to be depended upon. As the subsoil is open, and has outlets to the bottom lands and into drainage lines, the ground water drains out to the early fall, and the fall and winter precipitation passing downward, counteract any tendency to rise of alkali.

The peculiar conditions on the Egin Bench render this method a success although of course much plant food is carried away by the excess waters. This, however, is the only case known to the writer where "bringing up the sub," can be considered anything but a pernicious practice.

In the San Luis Valley in Southern Colorado, where bringing up the ground water by copious irrigation was deliberately practiced for years, the result has been the ruin of hundreds of

thousands of acres of fertile land by water-logging and alkali, and has depopulated many towns and rural districts like a pestilence. A cure will involve an expensive drainage system, and the adoption of more rational methods of irrigation.

In many regions ground water is raised by wasteful methods of irrigation, without any intent to subirrigate, but the result is the same, the rise of alkali and the swamping of the low-lying lands; in such regions there may be considerable areas where the ground water is nearly stationary, at about the right elevation to serve the plants without the surface application of water. This may be convenient for a time, but the constant upward percolation of water from the level of saturation to supply the draft of plant consumption and evaporation soon brings to the surface whatever alkali is in the soil, and if this is considerable eventually destroys its fertility.

a. Pipe Irrigation.—The application of water to the roots of plants underground, without bringing up the ground water, by means of pipes, is the true method of subirrigation, and may be made more economical of water than surface irrigation, for it reduces evaporation from the surface, and also obviates the losses due to percolation from unlined ditches.

In regions where water is valuable, it is becoming more and more the practice to line canals and laterals with cement, or to use pipe for distributaries instead of unlined ditches, which often waste large quantities of water by seepage, especially in sandy ground. The tile method of subirrigation is merely an additional step in this method of water conservation.

The head ditches or "mains" may consist of vitrified clay tile 4 or 5 inches in diameter with bell joints, sealed with cement. They should be located along the upper side of the field, or better still, should follow the crest of a ridge, so as to irrigate in both directions. Branches which are to conduct the water to the plants, are of smaller vitrified tile, usually about 3 inches in diameter, and laid with open joints so that the water can escape through the joint. Each joint should be protected by gravel or cinders, from entrance of sand or loam that would clog the pipe.

At each point where an open joint lateral takes out from the main, there should be a stop-box. This consists of a joint of larger pipe placed vertically with the bottom end closed, and the upper end open. Where two laterals join the main at one point, the stop-box should be placed in the main, but where only one lateral takes out, the stop-box should be at the side, and not interrupt the continuity of the main. Where the lateral or the main takes water from the stop-box, a plug or slide should be provided to shut off the water when desired. The laterals should have grades not over 4 inches nor less than 1 inch per 100 feet, and should be from 12 to 15 inches below the surface, or joint beyond the reach of the plow, and in parallel lines 15 to 20 feet apart. Both the depth and the horizontal intervals should be determined experimentally for each combination of soil and topography. Where the grade is more than 1 or 2 inches per 100 feet, it is best to place stop-pockets in the lateral at intervals of 200 to 400 feet so that the water can be checked and pressure produced to force the water out at the joints. The checking is best performed with sliding gates of galvanized iron. The length of time and amount of water required for a proper irrigation varies of course with the soil, the slope and other elements. To accomplish the correct degree of saturation without overdoing it requires great care at first, but experience with a particular field system soon makes it much easier. It should be the aim to bring the moisture within a few inches of the surface, but not quite to the surface. Very young plants require the moisture nearer the surface than older ones with deep roots, and as the object of subirrigation is economy of water, care must be taken to avoid over saturation, and escape of the water downward.

In Florida and other humid regions, where irrigation is practiced, this and similar methods are used for irrigation during drought, and for drainage in times of excessive rainfall. For such double use it is necessary to place the tiles considerably lower in the ground than when used for irrigation alone.

Underground application of water from pipes has not been extensively practiced. It is expensive, and has not achieved

the economy of water expected by some. It is moreover, subject to an important practical difficulty. The roots of growing plants are apt to seek the openings in their search for moisture, and to clog them and cause trouble. This is less apt to occur with annual than with perennial plants and with row crops set at some distance from the pipes than with those sown broadcast.

In some valuable orchard tracts where water is scarce and costly, it is conducted in iron pipes to individual trees and there delivered by a branch or a spigot, above the surface of the soil near the root of the tree. This avoids clogging the outlet with roots. A modification of this is used in numerous localities, mainly in humid regions for truck or small fruit gardens, where the water is applied under pressure to the pipes, and discharged in an overhead spray. In other cases a hose is used manipulated by hand.

As may be readily seen, all pipe systems of irrigation are expensive, and practicable only for intensive cultivation of valuable crops. The chief benefits of subirrigation, however, can be obtained more economically by the furrow method of irrigation from lined laterals, or pipes, and hence this combination is the one most generally in use in the citrus groves of California, where irrigation water has the highest value attained in any important district. By this means the water is applied to the entire root zone, without wetting any of the surface except in the furrows and immediately adjacent to them.

REFERENCES FOR CHAPTERS VIII AND IX

- STANLEY, F. W. Irrigation in Florida. Bulletin No. 462, Office of Public Roads and Rural Engineering, Washington, D. C.
- TEELE, R. P. Preparing Land for Irrigation. Year-book, Dept. of Agriculture, 1903.
- FORTIER, SAMUEL. Use of Water in Irrigation. McGraw-Hill Book Company, New York.
- ETCHEVERRY, B. A. Use of Irrigation Water. McGraw-Hill Book Company, New York.
- TAIT, C. E. Use of Underground Water for Irrigation at Pomona, Cal. Bulletin No. 236, U. S. Office of Experiment Stations.

CHAPTER X

DUTY OF WATER

IN order properly to plan a canal system, the designer must first decide upon the probable "Duty of Water" in the locality under consideration.

By "Duty of Water" is meant the area which can be served by a unit quantity of water. This may be expressed in two different ways. The most common practice is to speak of the area that can be served by a running stream of a unit volume, as "one cubic foot per second will serve 100 acres." It may also be expressed as the depth of water in one season required by the land in question. The former relation is the one necessary to determine the area that can be served by a natural stream without storage, and also dictates the necessary capacity of the canals. But when water is drawn from a storage reservoir the latter relation determines the area that can be served by a given volume of stored water.

The duty of water has been the subject of a vast amount of study and much valuable data has been published regarding it. Various factors affect the duty of water, the principal ones being these:

1. Length of season.
2. Natural rainfall, and evaporation.
3. Soil conditions.
4. Crops raised.
5. Preparation of ground and ditches.
6. Skill of the Irrigator.
7. Care with which water is used.
8. Cultivation.

Most of these conditions are variable and are not susceptible of accurate determination in advance. Nevertheless, some deci-

sion on duty of water must be reached, if we are to build an irrigation system.

1. Length of Season.—The arid portion of North America may be divided roughly into three general types as regards length of season and requirements for irrigation water, based thereon.

1. The northern division with short season, cool nights, and cold winters, comprising Canada, Montana, Wyoming and the Dakotas.

2. The southern division, with growing season nearly or quite the year round, long summers and mild winters, comprising California, Southern Arizona and Mexico.

3. The central division, with growing season of 5 to 7 months, warm summers and mild but frosty winters, comprising the greater part of the rest of the arid region.

Of course, these divisions merge in each other, and two classes are often represented in the same State. For example, the San Luis Valley in Southern Colorado belongs distinctly in the first division by reason of its high altitude, while the other principal valleys of the State, although further north, are milder, and belong to the third division. Similarly, other localities may not belong in the division their latitude would indicate.

The northern division, because of short season, requires less water than the others, but in the middle of the season requires a greater quantity within a short period while the crops are making their most rapid growth, due to the long days of midsummer, while the hours of sunlight are at their maximum. Experience shows that in northern regions the delivery capacity of the irrigation systems must be larger than is required in the more southern climes, although the total quantity of water delivered during the season is much less.

2. Natural Rainfall.—Any precipitation occurring in the growing season takes the place of a certain amount of irrigation water that would otherwise be necessary. Unless the shower occurs just after an irrigation so as to be largely superfluous, or is so heavy that much of it runs off the surface or

passes away through the subsoil, the rainfall replaces an equal quantity of irrigation water. In humid regions the natural rainfall is sufficient to mature good crops without irrigation. In semi-arid regions the same is true in a less degree, but irrigation, if feasible, can greatly increase the yield. In the arid regions the rainfall may be anywhere between zero and twenty inches in the growing season, and of course its amount and the time and manner of its occurrence profoundly affect the quantity of irrigation required. Even the precipitation of the fall and winter months has an important effect on the soil moisture available in spring and summer, especially if suitable precautions are taken to conserve this by proper cultivation. But as the natural rainfall varies from year to year, both in quantity and in time of occurrence, it is necessary to consider chiefly the years of lowest precipitation when planning the irrigation system. The water evaporated from the soil is of course not available for plants, and varies widely with climate, and with precautions to conserve it by cultivation.

3. Soil Conditions.—As we have seen (Chapter III), a loose sandy soil will not hold as much water as one of closer texture, and if the subsoil is also coarse it may be difficult to apply sufficient water for plant needs without large losses through the subsoil. Where the subdrainage is very free and the soil sandy and coarse, the temptation to over-irrigate is very great, and instances are known where farmers have applied sufficient water to cover the land to a depth of over 20 feet in a single season when the actual needs of the crop were perhaps only 10 or 15 per cent of that amount, the balance escaping to the ground water table, carrying with it much valuable plant food, and injuring neighboring lands.

4. Crops Raised.—Some crops require less water than others. Grains, for example, require less water for best results than alfalfa, and more than some fruits. It is therefore necessary to make some assumption as to what proportion will be planted of each crop adapted to the region. This proportion manifestly cannot be accurately predicted, and is, moreover, sure to change with time in a manner impossible to foretell.

5. Preparation.—If the fields be not properly leveled, an excess of water must be applied to some of the land in order to wet the remainder, and much may be wasted. If the sub-laterals and farm ditches are not of adequate capacity or the runs are too long, the upper ends will receive too much water before the water reaches the lower ends. In many ways the manner of preparation for the use of water will affect the economy of such use.

6. Skill.—Closely related to the preparation for irrigation is the skill with which the existing facilities are handled. This will vary with the experience of the farmer or of the help he may employ.

7. Care.—Even with adequate facilities and skill, the water may be wasted by carelessness if the necessity of care be not realized. Where water is abundant, its wasteful use is universal. The best insurance against careless handling as well as against poor facilities is to vary the water charges with the quantity of water used.

8. Cultivation.—If the surface of the soil is kept loosened to a considerable depth, and the fields are kept clear of weeds which would consume a great deal of water, a much higher duty of water can be attained than if the cultivation of the soil is neglected.

It will be noted that all except the first three of these conditions depend mainly upon the individual irrigator, and consequently cannot be predicted, and will vary with different irrigators, and with the same irrigator as he improves his practice. The duty of water must, moreover, be considered in two stages:

First, the "net duty," or the quantity actually used on the land.

Second, the "gross duty," or the quantity that must be diverted from the stream, or stored in a reservoir in order that the net duty may be fulfilled at the land. It, therefore, includes all losses from evaporation waste and seepage to which the water is subject before it reaches the farm.

The first question to be considered is the quantity of water actually needed by the various crops. Elaborate experiments

under various conditions of soil, crops and climate have been made by the U. S. Department of Agriculture and the various State Experiment Stations on this subject.

9. **Utah Experiments.**—The following table shows the average results from a large number of experiments at the Utah Experiment Station, Logan, Utah, on fine sandy loam:

TABLE XX.—ACREAGE YIELD OF VARIOUS CROPS FOR VARIOUS QUANTITIES OF IRRIGATION WATER

Inches of Water	Wheat. Bu.	Corn. Bu.	Alfalfa. Lbs.	Timothy. Lbs.	Orchard-grass. Lbs.	Oats. Bu.	Potatoes. Bu.	Sugar Beets. Tons
5	37.8	9,200	2,526	62.3	154	13.8
7.5	41.5	79.1	3,982	182
10	43.5	89.5	9,884	2,829	54.8	195	18.6
15	45.7	93.9	7,546	3,844	2,685	71.5	227	19.5
20	91.6	9,097	80.7	267	21.3
25	46.5	99.2	9,354
30	48.0	97.1	8,840	6,054	244	20.8
40	4,042	79.1	250
50	49.4	96.0	10,813	24.5
60	8,406	5,270	304
100	2,214	1,192

The above results have been substantially confirmed by other experiments, showing generally some increase with increasing amounts of water, but not by any means in proportion to the water used. In fact as will be seen by Table XXI the amount of product per unit of irrigation water decreases rapidly as the amount of water applied increases. These figures are obtained by reducing the results of the same observations.

The application of more water above a moderate amount not only gives little increase in yield of most crops, but actually diminishes some, and in nearly every case decreases the quality of the product. In all crops so far observed, the increase of water decreases the percentage of protein or nitrogenous compounds, which form the most important food element. The grains are made softer, and tend more to straw. Alfalfa and

other hay crops produce a greater percentage of woody material worthless for food as water is increased, potatoes and beets are made more watery and woody, and an excess of water upon cotton is distinctly hurtful.

TABLE XXI.—YIELDS OF VARIOUS CROPS, PER ACRE-INCH OF WATER APPLIED, FOR VARIOUS QUANTITIES OF IRRIGATION WATER

Depth of Water in Inches	Wheat. Bushels per Acre-inch	Corn. Bushels per Acre-inch	Potatoes. Bushels per Acre-inch	Sugar Beets. Tons per Acre-inch	Alfalfa. Pounds	Carrots. Tons
5	7.6	...	31	2.8
7.5	6.4	6.1	24	2.2
10	4.3	5.8	20	1.9	988	...
15	3.0	4.6	15	1.3	503	1.6
20	...	3.6	13	1.1	455	...
25	1.9	3.2	374	0.9
30	...	2.7	8	0.7	295	...
40	1.3	...	6	0.8
50	1.0	1.4	...	0.5	216	...
60	5	0.6
100

In most arid districts where irrigation is possible, the area of arable land is far in excess of the water supply, so that the limit of production is the available water, and the economy with which this is used has a profound effect upon the product, as shown by Table XXII, showing the results of applying a given quantity of water to various areas. These figures are obtained by reduction of the observations at the Utah Experiment Station, given above.

As irrigation water always costs something, even when most abundant, and as it also costs something to apply it, it is always economical to apply less than the quantity giving the maximum yield, and generally, when both cost and value of results are given due consideration it pays to stop far short of the maximum.

The natural precipitation available for plant growth includes not only that which falls upon the growing crops, but such

portion of the winter precipitation as is retained in the soil within the zone of plant root feeding. The amount thus retained depends partly upon the natural soil and climatic conditions, and partly upon the efforts which are made through cultivation to facilitate its absorption and retard evaporation.

TABLE XXII.—YIELDS OF DIFFERENT CROPS FROM THE APPLICATION OF 30 INCHES OF IRRIGATION WATER TO VARIOUS ACREAGES

	1 Acre	2 Acres	3 Acres	4 Acres	6 Acres
Wheat (bushels)	48	91	130	166	227
Corn (bushels)	97	188	268	316
Alfalfa (pounds)	8,840	15,092	29,652	55,200
Timothy (pounds)	6,054	7,688	15,928
Potatoes (bushels)	244	454	585	728	924
Sugar beets (tons)	20.8	39.0	55.8	82.8

10. Agricultural Department Experiments.—By a large number of careful measurements, it has been found that in the Inter-Mountain Region with about 8 inches of rain, the amount of water required on loam soils for best results varied from 1 foot to 3 feet in depth on the land, in the season, the average being 1.5 feet for grain and row crops, and 2.5 for alfalfa. Under normal conditions of diversified farming an average of 2 feet in depth is sufficient for the crops, but an allowance of 10 to 20 per cent should be made for waste under good conditions, and if the soil be very sandy, or have an open subsoil within 5 feet of the surface, it will be difficult to avoid large losses into the subsoil, and allowance for this must be made, which may run very high in some cases, unless extreme care is taken in applying the water. The average uses on the Minidoka Project in Southern Idaho, having a wide variation in soil conditions varied from 2.5 feet for loam soils, to 12 feet for sand with gravelly subsoils.

The following table is the result condensed from a number of careful observations:

TABLE XXIII.—OPTIMUM QUANTITIES OF WATER FOR VARIOUS CROPS, ON RETENTIVE SOILS, WITH GOOD CULTIVATION

	Max. Yield	Optimum	Page
Potatoes (clay loam)	26	24 inches, Bark	47
Potatoes (sandy loam)	24 inches, Utah	..
Sugar beets (fine sandy loam)	30 inches, Utah	48
Sugar beets (clay loam)	30 inches, Utah	..

From measurements on more than 100 farms in Southern Idaho, in 1915 and 1916, Bark concluded that average diversified farming on loam soils, required an average monthly application as follows:

April	1	per cent of total application		
May	19	"	"	"
June	28	"	"	"
July	33	"	"	"
August	17	"	"	"
September 1-15 .	2	"	"	"
Total	100			

The percentage required in April and September would be greater in a warmer climate with longer season, which would, of course, diminish the percentage in other months.

11. In the U. S. Reclamation Service it has been the general practice to measure the water used in irrigation, and the extension act passed in 1914 requires maintenance charges to be fixed according to the amount of water used, a practice previously followed on a few of the projects. As a result, we have a good deal of accurate data on water duty upon those projects. Some of these data are condensed in Table XXIV.

Familiarity with local conditions lends increased interest to the above table. The first important condition is the length of season, the projects in Southern Arizona having a season of 365 days, while all the rest have shorter seasons. Notwithstanding this fact and the further fact that they receive less than 8 inches of rainfall, the total quantity of water applied per acre is less than upon many of the projects of shorter season

TABLE XXIV.—YEARLY AMOUNT OF WATER USED ON U. S. RECLAMATION PROJECTS

State	Project	Average ¹ Annual Rainfall, Inches	Irrigation Season, Days	DUTY, ACRE-FEET PER ACRE ²							
				1910	1911	1912	1913	1914	1915	1916	1917
Arizona	Salt River	8	365	3.60	3.53	3.94	2.97	2.62	2.66	2.58	2.67
Ariz.—Cal.	Yuma	2.9	365	3.10	5.43	4.60	4.36	3.69	3.34	3.20	3.70
California	Orland	17	270	3.9	3.97	3.00	4.08	3.40	4.07	3.50
Colorado	Grand Valley	8.4	214	2.42	3.54
Colorado	Uncompahgre	9.5	214	6.25	5.44	4.81	5.00	5.06	5.56	6.08	5.96
Idaho	Boise	12.8	214	1.67	1.79	1.93	2.38	2.02	2.81	3.56	3.10
Idaho	Minidoka	12.6	214	7.30	5.9	4.3	5.0	4.3	3.9	3.7	3.10
Montana	Huntley	13.8	153	2.03	1.88	1.50	1.53	1.43	0.97	1.13	1.10
Montana	Milk River	14.0	170	0.82	0.92	0.86	0.69	0.67	1.01
Montana	Sun River	11.2	148	2.30	1.65	1.71	1.5	1.73	1.1	1.22	1.40
Mont.—N. Dak.	Lower Yellowstone	16.2	163	1.44	1.41	1.19	1.34	1.59	1.42	1.25	1.77
Mont.—Wyo.	North Platte	14.4	183	3.93	4.26	2.25	2.49	2.92	1.38	2.17	2.13
Nevada	Truckee—Carson	4.0	108	4.65	4.46	2.50	2.26	3.28	2.04	3.32	3.10
New Mexico	Carlsbad	15.2	260	2.4	2.20	2.90	2.30	2.40	2.14	2.43	2.30
N. Mex.—Texas	Rio Grande	10.6	274	4.4	6.00	5.40	4.34	5.68	5.90	6.73	8.40
N. Dakota	North Dakota Pumping	13.8	80	1.63	1.23	0.66	1.31	1.70
Oregon	Umatilla	8.8	210	10.2	9.7	8.12	8.45	7.10	5.57	5.00	6.19
Oreg.—Cal.	Klamath	14.2	153	0.88	1.23	1.13	1.17	1.05	1.12	1.02	0.97
S. Dakota	Belle Fourche	15.0	152	1.95	1.64	1.10	1.44	1.45	0.37	0.81	1.21
Utah	Strawberry Valley	14.5	109	1.75
Washington	Okanogan	12.5	123	2.46	1.27	1.24	1.57	2.59	2.38	2.50	2.50
Washington	Sunnyside Unit	6.7	214	3.29	3.08	3.06	3.10	3.31	3.03	2.53	3.16
Washington	Tieton Unit	7.0	153	1.73	1.91	2.27	2.27	2.09	1.83	2.15	2.30
Wyoming	Shoshone	5.9	175	2.05	2.20	1.66	2.08	2.38	2.12	2.34	2.10

¹ Based on records for five to thirty-seven years; in nearly all cases ten years or more.

² Measured delivery to individual farms in all cases except Rio Grande project where figures represent deliveries to laterals.

TABLE XXV.—OPERATION AND MAINTENANCE AND RENTAL CHARGES FIXED UPON RECLAMATION PROJECTS FOR 1918

State	Project	MINIMUM CHARGE		Charge per Acre-foot for Additional Water
		Amt.	Acre-feet per acre	
Arizona.....	Salt River.....	\$1.25	2	@ \$.75.
Ariz.-Cal.....	Yuma.....	1.50	2	@ \$.75.
California.....	Orland.....	1.50	2½	1 @ \$.50; 1 @ \$.25; 1 @ \$.15; then @ \$.50.
Colorado.....	Uncompahgre.....	1.00		
Idaho.....	Boise.....	.75	1	@ \$.20 to June 30; then @ \$.40.
Idaho.....	Minidoka (Pump).....	1.50	*	@ \$.50 to June 5; @ \$1 June 6 to Oct. 20.
Montana.....	Huntley.....	1.50	1½	\$1.10 July 8 to Aug. 31; @ \$.50 other times.
Montana.....	Sun River.....	1.70	1½	@ \$.50.
Mont.-N. Dak.....	Lower Yellowstone.....	.75	1	@ \$.50.
Nebr.-Wyo.....	North Platte.....	1.50	*	@ \$1 June 21 to Aug. 31; @ \$.50 other times.
Nevada.....	Truckee-Carson.....	1.25	1½	@ \$.40.
New Mexico.....	Carlsbad.....	1.15	1	1 @ \$.10; @ \$.15; 1 @ \$.50; then @ \$.75.
Oregon.....	Umatilla.....	1.50	4	1 @ \$.15.
Ore.-Cal.....	Klamath.....	1.25	2	1 @ \$.40; then @ \$.60.
So. Dakota.....	Belle Fourche.....	1.25	*	1 @ \$.50.
Utah.....	Strawberry Valley.....	1.00	2	@ \$.50.
Washington.....	Okanogan, A lands.....	1.50	1	@ \$.50.
	B lands.....	1.50	1½	@ \$.50.
Washington.....	Sunnyside, A lands.....	1.25	2	@ \$.50.
Washington.....	Tieton.....	1.25	*	@ \$1 June 20 to Aug. 31; @ \$.60 other times.
Wyoming.....	Shoshone.....	1.00	*	@ \$1 July and Aug; @ \$.50 other times.
				@ \$.75 June 16 to Aug. 16; @ \$.50 other times.

* Minimum charge does not entitle to any specific quantity, but is credited against charge made up as shown in last column.

and greater rainfall. At Yuma, however, a high ground water table assists in keeping down the quantity of water needed. Altogether, without much question, considering all conditions, Salt River Valley shows the best practice in water economy of any of the projects. This is due to the evenness of surface and slope, to an excellent system of rotation, and to frequent cultivation, the outgrowth of the high value of water and experience in its use.

The best practice of any Northern project on the list is on the Huntley, although the high duty there is partly due to favorable climate and soil. The most wasteful practice is upon the Rio Grande project, where with shorter season, and somewhat greater rainfall, more than twice as much water is applied as at Salt River. This is the less excusable as most of the Rio Grande Valley has a high water table, and some is actually water-logged; nor is there any very open soil, requiring much water. The main explanation is the community operation of laterals in which no control is exercised over the amount of water used, and the primitive methods of irrigation. It is fast ruining the land, and strenuous efforts are being made by the leading men to induce the small communities to surrender the canals to the Government, and to establish rigid control and severe penalties against water waste.

Next in order of reckless waste is the Uncompahgre project, which uses in seven months more than twice as much water as Salt River does in twelve. Although the valley has a steep slope and good natural surface drainage, the excessive application of water has water-logged considerable areas of land, and this area is increasing. The sale of water by the second-foot instead of by the acre-foot is one of the leading causes, as it offers no inducement to economy except at the peak of the season. This practice is the outgrowth of local habit, and efforts are being made to change it.

Excessive quantities of water are also used on the Umatilla Project, but this is due to open sandy soil with very coarse sub-soil, through which the water readily sinks beyond the reach of crop roots, and frequent irrigation is required. The same is

true on a large part of the Minidoka and Orland projects, and on parts of the Bois  and Truckee-Carson Projects. The Sun River, Milk River, Lower Yellowstone, Belle Fourche and Klamath Projects are in semi-arid regions, receiving the major portion of their rainfall in the growing season, and crops are often raised without irrigation. They therefore use only small quantities of irrigation water.

12. A Committee on Irrigation from the American Society of Agricultural Engineers addressed a questionnaire to several hundred leading men concerned directly or indirectly with irrigation, whose opinions on the subject were deemed important. The replies concerning the duty of water are condensed in the following table:

TABLE XXVI.—AMOUNT OF WATER USED ANNUALLY

Class of Soil	CEREAL CROPS		FORAGE CROPS	
	Depth	Acres per Second-foot	Depth	Acres per Second-foot
Light.....	2.1	155	3.1	80
Medium.....	1.9	187	2.5	75
Heavy.....	1.2	242	2.1	105
Average.....	1.7	195	2.6	87

Independently of careful scientific observations, are numerous community experiences which throw valuable light on the duty of water in a large community in a long series of years. On this point Fortier says: *

“Some twenty-five years ago the irrigators of the Greeley district in Northern Colorado were using a second-foot of water on 40 to 50 acres. In recent years the same quantity has served fully three times as much land with far better results when measured in crop yields. Again, in the early nineties, the farmers in the Bear River Valley in Northern Utah used a second-foot on 60 to 80 acres, but during the past few years the average duty has been a second-foot for 120 acres. Furthermore, when the Legislative Assembly of Wyoming in 1891 limited the duty throughout the State to one second-foot for each 70 acres, it was actuated by the best of motives. Such a duty was then high. Now it is too low and the State is handicapped by having apportioned so large a volume of its public waters on the limit fixed by statute.”

* Use of Water in Irrigation, page 135.

In a decision by the Supreme Court of Arizona in 1910, the duty of water for Salt River Valley was fixed at 48 miner's inches, or 1.2 second-feet, for each quarter section of land. This is equivalent to $133\frac{1}{3}$ acres to the second-foot. It should be noted that this use is in a very hot and very dry climate, where for months at a time no rainfall appears to assist in moistening the crops, the mean annual rainfall being about 8 inches.

This rule limiting water usage has been in force for about seven years, and has aroused no complaint of shortage, as experience shows this quantity to be ample even for those crops of greatest requirement, and on sandy soil. In fact the records of water delivery show an average use throughout the year only about 3 feet in depth on the land actually irrigated, although the irrigation season is twelve months in length.

This is only about one-half the full use of the above allowance as an average, so that it is evident that this full use is invoked only in mid-summer, and that the demand is reduced to an average of about one-half in spring and autumn, and one-fourth in winter. The marked improvement over the water duty of other regions, and of the same valley in former years, is due to the increased value of water, and a charge in proportion to quantity used, leading to more careful and more skillful use. The leading practices developed by this condition are:

1. An efficient system of rotation, delivering only a day in eight, and use of large heads.
2. Careful preparation of the land.
3. Re-use of waste water for irrigation, by picking it up at lower end of the field.
4. Cultivation of the land soon after each irrigation.

Even with these practices considerable areas in Salt River Valley have become waterlogged, and these areas are growing.

Of course there remains much room for improvement in these and similar practices, so that the high duty of water can be made practicably much higher. This will undoubtedly be done as the value of water advances.

That such a hope is well founded is demonstrated by irrigation practices in Southern California, where nearly double this duty is obtained, by more thorough employment of the above precautions and by the use of pipes and lined canals, cement head ditches and other devices for saving water. Perhaps the most important measure that has led to such a high duty and such successful results from irrigation in Southern California is the habit of thorough cultivation of the surface as soon as possible after each irrigation and each heavy shower of rain. This provides a soil mulch which conserves the moisture and also destroys all weeds which has the same tendency. The results obtained in Arizona are easily reached in any region by the adoption of the simple measures enumerated, which are good in themselves, and should be applied nearly everywhere. The results in Southern California furnish the goal towards which Arizona and all the rest should strive.

The Utah Agricultural College has done much useful work in teaching and spreading information in favor of greater care in the use of water. In conjunction with the State Conservation Commission it has widely promulgated the following twelve rules for the use of irrigation water:

1. *Store the Rainfall in the Soil.*—Deep, thorough plowing enables the soil to absorb and retain most of the rain and snow water. The more rainfall is stored in the soil the less irrigation water will be needed.

2. *Cultivate Frequently and Thoroughly.*—Water is easily lost from soils by evaporation. Stirring the top soil reduces this evaporation. The soil should be thoroughly cultivated early in the spring, as soon as possible after irrigation, and usually once or more between irrigation. Thorough cultivation will reduce the water needed in irrigation.

3. *Keep the Soil Fertile.*—The more fertile a soil is, the less water is needed to produce a pound or ton of the crop. Plow deeply, cultivate thoroughly, use barnyard manure, and less irrigation water will be needed.

4. *Plant in Well-moistened Soil.*—Well-moistened soil at planting time permits better root development, and delays the

time of the first irrigation, and thus saves irrigation water during the summer. If rains and snow do not moisten soils sufficiently for planting, irrigate in fall, or in early spring, before planting.

5. *Don't Irrigate too Early.*—By postponing as long as possible the first irrigation after planting, a better root development is secured and less irrigation water is needed to produce the crop.

6. *Irrigate by the Correct Method.*—Where water is plentiful, the flooding method may be used; where water is scarce, the furrow method only should be employed. Lead the waste water from the furrows to other fields.

7. *Irrigate at the Proper Time.*—Withhold water until the crop is in real need. When irrigating, apply enough water to supply the crop for at least ten days. Irrigate thoroughly when potatoes are in bloom; corn in tassel or silk; lucern just beginning to bud, and grains forming seed.

8. *Use Water in Moderation.*—The acre yield of a crop increases as more water is used, up to a certain limit, beyond which more water causes a decrease in the yield.

9. *Spread the Water over Larger Areas.*—The yield of crop per unit of water always becomes smaller as more water is added. The less water is used in irrigation, the more crop is obtained for the water used. In Utah land is plentiful, water is scarce; it is more important to get a large crop for each acre-foot of water than for each acre of land.

10. *Kill the Weeds.*—Weeds use as much water as do many profitable crops. It costs usually 2000 pounds of water to produce 1 pound of weeds. Killing the weeds will leave more water for our crops.

11. *Repair the Leaky Ditches.*—Tremendous quantities of water seep from most of our canals and ditches. Stop the leaky places. It will often pay to cement the whole canal.

12. *Measure the Water.*—Land is measured carefully, but water, more valuable than land, is seldom measured. Great progress will be made by Utah as soon as farmers faithfully measure and keep an account of the water used on the land.

This is one of Utah's greatest irrigation needs. The Cippoletti Weir may be used by any farmer for the measurement of water.

REFERENCES FOR CHAPTER X

- WIDTSON, JOHN A. Principles of Irrigation Practice. Macmillan Company, New York.
- BROWN, HANBURG.—Irrigation, Its Principles and Practice. D. Van Nostrand Co., New York.
- FORTIER, SAMUEL. Use of Irrigation Water. McGraw-Hill Book Company, New York.
- CARPENTER, L. G. Duty of Water. Bulletin No. 22, State Agricultural College, Ft. Collins, Colorado.
- MEAD, ELWOOD, and Others. Use and Duty of Water in Irrigation. Bulletin No. 86, U. S. Office of Experiment Stations.
- U. S. Reclamation Service. Sixteenth Annual Report.
- WILSON, H. M. American Irrigation Engineering, Part II, 13th Annual Report, U. S. Geological Survey.
- MEAD, ELWOOD. Report on Irrigation on Investigations for 1904. Bulletin No. 158, U. S. Office of Experiment Stations.
- TEELE, R. P. Review of Ten Years of Irrigation Investigations. Annual Report of U. S. Office of Experiment Stations for 1908.
- NEWELL, F. H. Annual Reports on Operation and Maintenance of Reclamation Projects, 1910-11-12-13, U. S. Reclamation Service.
- BARK, DON H. Duty of Water Investigations in Idaho. Parts of 8th and 9th Biennial Reports of State Engineer of Idaho, for 1910-11-12.
- Inquiry of Am. Soc. of Agricultural Engineers. Reclamation Record, April, 1918.

CHAPTER XI

MEASUREMENT OF IRRIGATION WATER

WATER measurements in connection with an irrigation system are of two main classes.

First are those measurements of the stream and of the main canal and larger laterals which are of use in the operation of the system, and do not bear directly upon the amount of water delivered to the individual irrigator. The streams or canals measured are of considerable size and the methods employed in measurement are similar to those used in gaging rivers.

The second class of measurements are those designed to indicate the amount of water delivered to each irrigator. They are of relatively small amounts, and to obtain the necessary degree of precision, require the use of other means than those usually employed on large streams.

1. Gaging Streams.—The first step in the study of the water supply should be the establishment of systematic observations of stream flow at the various points where such data are required, and records of the daily flow should be kept. A gage should be provided by which to observe the height of the surface of the water in the river and should be observed daily or oftener so as to obtain correct results of the daily mean. The simplest form of gage is a wooden rod, graduated in feet and tenths so as to be easily read, with the graduation made permanent with nails or otherwise, so that the action of the water will not obliterate them. A position should be selected for the gage rod where it will be protected from driftwood, and yet be easily read, and show the true height of the water in the river. If no better plan presents itself, the rod may be laid on the ground sloping up from the river, and fastened firmly to stakes or posts. The graduations may then be located on it by means

of a Y level. Such a gage may be read twice a day, and this will give fair results on most streams.

Somewhat more reliable results may be obtained by providing a well near the river above high water, the bottom of which extends somewhat below low water, and connecting the bottom of the well with the river by a horizontal pipe, so that the water in the well will always stand at the level of the water in the river. By this arrangement difficulty with driftwood is avoided, and observations may be accurately taken with a hook gage. If greater accuracy is desirable, or if the river is subject to sudden fluctuation, it may be advisable to install a mechanical self-recording gage, of which several are on the market. They require frequent attention to keep them in order, but by making continuous record give much greater accuracy on a fluctuating stream than periodic observations of a gage. Measurements of the actual discharge of the stream should be made at frequent intervals, depending upon the character of the stream bed. If this is of permanent character, a complete series of measurements taken at high, low, and intermediate stages will serve to establish approximate values for the various gage heights, and permit the construction of a curve of discharge; and thereafter measurements need be made only sufficient to check the stability of the cross-section and to confirm the stability and reliability of the gage. There are few river channels, however, except those in solid rock, that are naturally so stable that they do not undergo material modification in times of flood, so that in practice it is usually necessary to take a series of measurements every year. Especially is it important to secure measurements of extreme high and low water, so as to control the extremities of the curve of discharge.

The discharge of the stream should be measured in the vicinity of the gage, so that no appreciable gain or loss can occur between.

The depth may be measured by a rod or sounding line at measured intervals across the stream, each sounding representing half the distance to the next sounding adjacent on each side. The frequency of the soundings should depend upon

the roughness of the channel, a few soundings being sufficient where the stream is of nearly uniform depth, and only roughly approximate results are required. For convenience, the soundings may be made equidistant, and each sounding should be multiplied by the width of the section which it represents. This will give the area of that cross-section, and the sum of all these cross-sections will give the cross-section of the stream, and this multiplied by the mean velocity of the water will give the total discharge

A rough preliminary measurement of velocity may be made by surface floats, timing their passage over a measured course. The mean velocity will be about nine-tenths of the average surface velocity in ordinary streams with smooth bottoms and

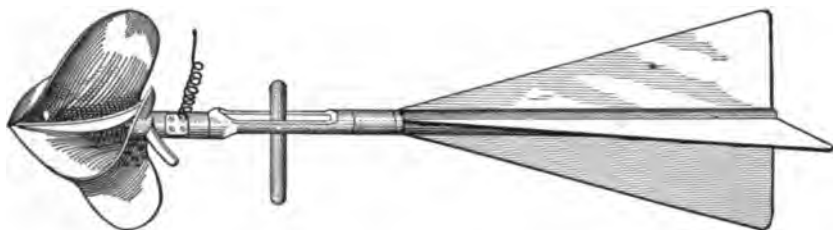

FIG. 48.—Haskell Current Meter.

somewhat less, for rough gravelly sections. A convenient form of surface float is a tall bottle, with just enough water in it to make it float upright, and a white rag attached to the cork to make it conspicuous. Several such floats should be passed over the course at different parts of the stream and the time carefully taken. A straight course should be selected free from eddies or material changes in section. More reliable and accurate measurements of velocity may be made with a current meter, of which several efficient types are obtainable. Those most used are the Price meter, Fig. 49, and the Haskell meter, Fig. 48.

The Haskell meter has a slight advantage in responding only to the component of water motion parallel to the axis of

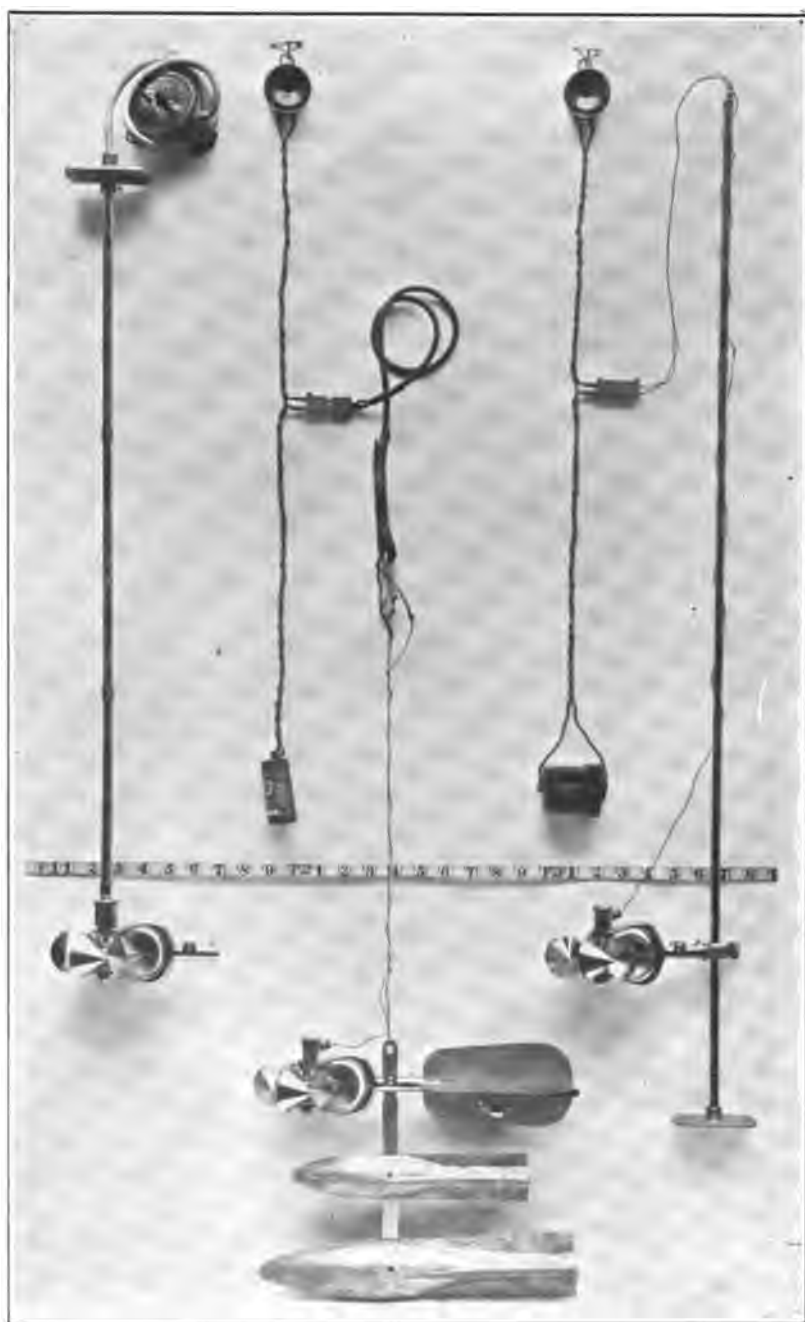

FIG. 40.—Price Electric and Acoustic Current Meters.

the meter, but will not register velocities as low nor as high as the Price meter, and if the shaft on which it revolves becomes slightly roughened by rust, or otherwise, it seriously affects the coefficient of friction, and hence the rating of the meter.

The electric meter which has been found to work most satisfactorily under nearly all the varying conditions of depth and velocity by the hydrographers of the U. S. Geological Survey and U. S. Engineer Corps is the small Price electric-current meter (Fig. 49). It is accurate for streams of nearly any velocity, and is practically standard with both organizations. Each revolution of the wheel is indicated by a sounder, consisting of a telephone receiver excited by a small battery cell. Two small insulated wires, attached to the stem and to the contact spring in the head, are connected with the sounder through the suspending cable.

The Price acoustic current meter is a modification of the Price electric meter. It is especially desirable for its portability and ease of handling as it weighs but little over a pound. In very shallow streams it gives the most accurate results of any meter, and is held at the proper depth by a metal rod in the hands of the observer. It is designed especially to stand hard knocks which may be received in turbid irrigation waters, and can be used in high velocities, as only each tenth revolution is counted. Its head, like that of the electric meter, consists (Fig. 49), of a strong wheel composed of six conical-shaped cups, which revolve in a horizontal plane; its bearings run in two cups holding air and oil in such manner as entirely to exclude water or gritty matter. Above the upper bearing is a small air-chamber, into which the shaft of the wheel extends. The water cannot rise into this air-chamber, and in it is a small worm-gear on the shaft, turning a wheel with twenty teeth. This wheel carries a pin which at every tenth revolution of the shaft trips a small hammer against the diaphragm forming the top of the air-chamber, and the sound produced by the striking hammer is transmitted by the hollow plunger-rod through a connecting rubber tube to the ear of the observer by an ear-piece. The plunger-rod is in 2-foot lengths, and is graduated to

feet and tenths of feet, thus rendering it serviceable as a sounding or gaging rod.

2. **Use of the Current Meter.**—A bridge spanning a stream without piers in the channel is the most convenient provision for using a current meter. Even one or two piers in the stream may be tolerated if they are not clogged with drift, and do not greatly interfere with the smooth flow of the water. If the stream is sufficiently shallow, a resort to wading may be practicable at time of low water, but obviously will not do at high water, nor at any time when the velocity is high, as the body of the observer will cause eddies and vitiate the results.

In the absence of a bridge without piers in the stream, the best provision for gaging is to stretch a cable across the stream, and from this suspend a small car in which the observer can ride, propelling the car by pulling on the cable, and stopping at certain points indicated by a tagged wire parallel to the cable. The diagram, Fig. 52, shows such a station. In the absence of the car a boat may be used, anchored to the cable, but this somewhat interferes with the current, and is apt to swing about during the observation and impair its accuracy.

In lowering a current meter into a deep stream in time of flood, the strong current tends to carry it downstream, and to prevent its reaching the bottom or any considerable depth. To remedy this tendency, a heavy wire may be stretched across the river 50 or 100 feet above the gaging section, and upon this wire a small pulley is carried from which a smaller wire extends to the meter line, to which it is attached just above the meter and prevents its deflection downstream.

A flowing stream has a sloping surface, and moves under the action of gravity, retarded by friction on the bottom, the banks, and in a small degree on the air. The lowest velocity is at and near the bottom and sides on account of their retarding effect. The maximum velocity is just below the surface, in the central portion of the channel, unless a deeper part exists, in which case the depth may vary that law. In order to find the mean velocity of the water in any vertical line, several methods are in use.

1. The integration method is the moving of the meter slowly and regularly from surface to bottom, and to surface again. This must be done so slowly that the vertical motion of the meter will be an insignificant fraction of the horizontal motion of the water, otherwise the correctness of the record may be affected especially with the cup type of meter such as the Price meter.

2. The measurement of velocity at six-tenths of the depth, has been found to generally give results approximating the mean velocity of the vertical line passing through the point measured.

3. In deep streams the mean of measurements of velocity at surface, mid-depth and bottom will give a close approximation to the mean velocity.

Good results from current meter measurements cannot be obtained except at reaches where the channel is fairly straight and regular, and practically free from whirlpools, eddies and back currents.

An overflow dam or weir furnishes an excellent opportunity for measuring the discharge of a stream, if it is fairly smooth and regular along its crest. If it has a large bay of nearly quiet water back of it, the discharge may be computed by one or other of the empirical formulæ, by measuring the height of the water above the crest of the weir at a point above the line of accelerated velocity, where the measurement gives the general height of the still bay.

If the pond above the dam has been filled with sediment, the various weir formulæ are not applicable, but the weir may be calibrated by measuring the stream with a current meter a short distance above or below the weir, and when once this is well done, for all stages from extreme low water to extreme flood stage, the stability of the weir, if it be of masonry, insures accurate results as long as no change occurs in the shape or elevation of the weir crest.

Where the section measured is sandy and constantly shifting, the gage readings cannot be depended upon as indications of discharge unless checked frequently by actual complete discharge

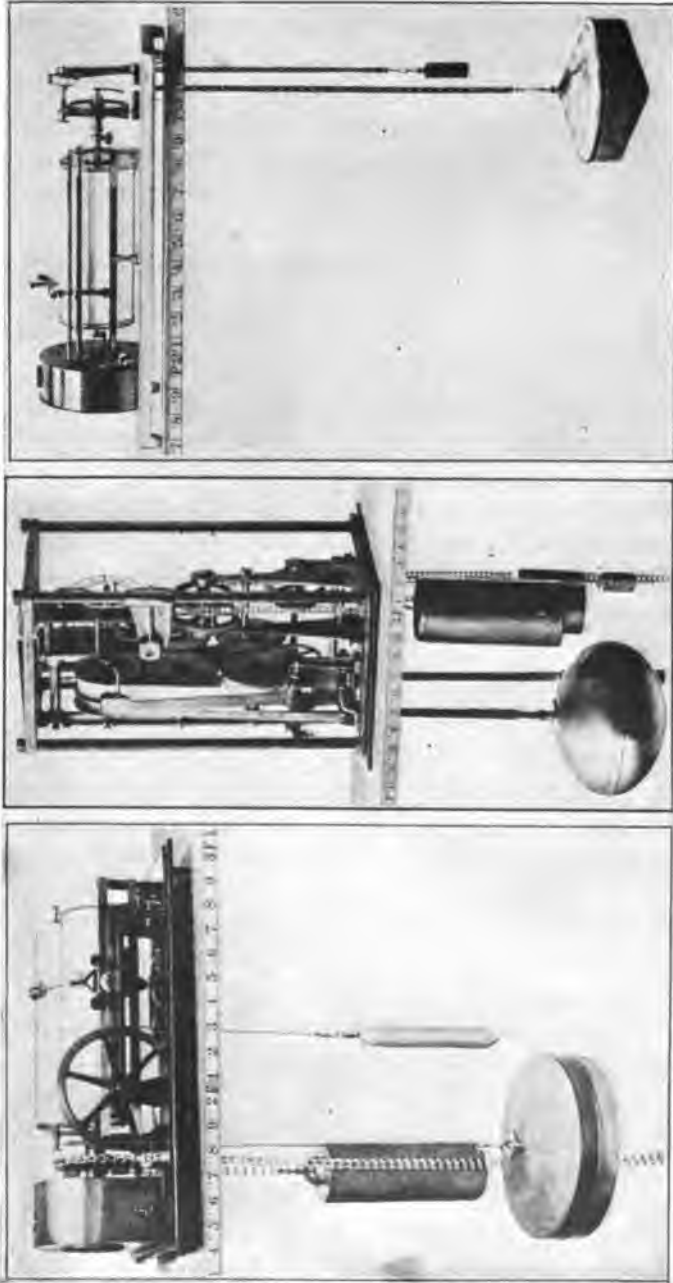

a. Stevens.

b. Gurley Printing.
FIG. 59.—Water Stage Recorders.

c. Friez.



FIG. 51.—Cable Gaging Station, with Automatic Continuous Recording Gage.



FIG. 52.—Cable and Car Gaging Station.

measurements. Such streams are the Colorado, Rio Grande, Arkansas and Platte after they leave the mountains.

These streams scour their channels at time of high water and fill them again at low stages, and at all times are building bars or cutting banks, and their channels are thus constantly shifting, so that unless a fixed weir can be used, it is necessary in order to get accurate results to make very frequent measurements, ranging from daily in times of high water, to semi-



FIG. 53.—Wire and Boat Gaging Station.

weekly or weekly at low stages. Even these results are not as accurate as less frequent measurements on streams with gravel channels.

Where the channel is of coarse gravel or boulders and hence relatively stable, the principal changes occur at times of flood and a measurement or two at or near the peak of the flood and at extreme low water, with a few at intermediate stages,

generally give a good rating curve to serve till the next flood stage. The rating curve at such places is often very stable, but should be checked carefully at and after each flood stage.

Streams through clay regions are apt to be more shifting than those with gravel sections, but are generally susceptible of fair determination by the methods just described, with somewhat more frequent measurements. No section is entirely free from change unless of rock, or of concrete or other artificial construction.

In cold countries like the Northern United States and Canada special problems and considerable difficulty are presented in measuring frozen streams. In the early winter needle and anchor ice are apt to form in rapids and flow in masses, sometimes even clogging the stream where frozen over, and causing back water. The surface of the stream may freeze at the edges, leaving the center of the channel open, thus complicating the work of measurement.

After the channel freezes over the discharge measurements are made through holes in the ice, large enough to allow the current meter to pass through freely. The depth of the stream is taken as the distance from the bottom of the ice to the bottom of the stream. The velocity is taken by the vertical velocity-curve method, which as adapted to winter use, may be described as follows:

The meter is held just below the lower surface of the ice, and the velocity at that point recorded. This is repeated at different depths throughout the vertical. These results are plotted with velocities in feet per second as abscissæ, and their corresponding depths in feet as ordinates, and a curve is drawn through the points. The mean velocity is obtained by dividing the area included between the curve and its axis, by the depth. This may be measured by planimeter, or estimated by squares. A close approximation may be more easily obtained by dividing the depth into a number of equal parts, taking corresponding velocities from the curve and averaging these. The mean velocity multiplied by the depth as measured will give the discharge.

3. Hydraulic Formulæ. In 1775, Chezy, a French engineer, developed a formula for computing the flow of water in conduits, either open or closed.

$$V = C\sqrt{RS}.$$

Where V = the mean velocity of the water;

R = The hydraulic radius of the stream obtained by dividing the area of cross-section of the stream by the wetted perimeter;

S = the tangent of the angle of slope;

C = a coefficient then supposed to be constant, but now known to vary with several factors, especially the friction of the channel.

The researches of Ganguillet and Kutter produced important modifications of the above formula, in which the factor C is replaced by an expression which takes into account the roughness of the channel, and certain functions of the slope and the hydraulic radius. The friction is represented by the variable " n ." This formula, which is in general use for open conduits, and also to some extent for closed conduits, is expressed thus:

$$V = \left\{ \frac{\frac{1.81}{n} + 41.6 + \frac{.0028}{s}}{1 + \left\{ 41.6 + \frac{.0028}{s} \right\} \frac{n}{\sqrt{r}}} \right\} \sqrt{rs}.$$

The value of the factor " n " is empirical and must be assumed largely upon judgment, owing to the difficulty of defining with accuracy the multitude of details which effect the retarding influence of the channel.

4. Measurement of Water to the User.—The accurate measurement of water to each irrigator is a prime necessity of every irrigation system. Where the water supply is limited, and the area of irrigation is thereby limited, as is generally the case, it is important that the most economical use of water be secured, in order that the largest area may be irrigated and the greatest production thereby secured. It is still more important

to prevent excessive application of water, because where permitted it is almost certain to cause an injurious rise in the water table and the resulting injuries from rise of alkali, water logging etc., which are more likely to occur where water is plentiful than where it is scarce. It is thus very important to limit the amount of water supplied to that actually required for plant consumption, as nearly as this can be attained in practice. This requires great care, both in preparation of the land and in the application of the water, and no measures have been found more efficient than those which engage the direct financial interest of the irrigator by charging for water service by the quantity of water used. To do this requires careful and systematic measurement of the water to each irrigator.

The standard unit for the measurement of flowing water in English-speaking countries is the cubic foot per second. This may be defined as a stream of such velocity and volume that one cubic foot of water passes a given point in a second of time. If the mean velocity of the stream is one foot per second, and the cross-section is one square foot, the flow is one cubic foot per second. For brevity the cubic foot per second is called a "cusec" in India, and in America it is called a "second-foot." American irrigators often use another unit having its origin in placer mining, called the "miner's inch," from the discharge of a square inch orifice under a given head. The varying values of this unit under the wide variety of conditions of flow created such confusion that legislative attempts have been made to define the miner's inch in terms of the standard unit, the second-foot. In Colorado the statutes provide that 38.4 miner's inches shall equal one second-foot. In Arizona, California, Montana and Oregon, a miner's inch is one-fortieth of a second-foot, while in Idaho, Kansas, Nebraska, New Mexico, North Dakota and South Dakota it is one-fiftieth of a second-foot, and in other States no definite values have been assigned.

This variation unfits the miner's inch for use as a common standard, and we are forced to adhere to the second-foot as the standard unit for expressing the volume of flowing streams.

Where volume is considered independent of the element of

time, the acre-foot has been generally adopted. It is the quantity of water that will cover an area of one acre to the depth of 1 foot, and is hence 43,560 cubic feet.

As a subdivision of the acre-foot, acre-inch is often used, being one-twelfth of the acre-foot, or 3630 cubic feet. The acre-foot is an especially convenient unit of volume from its ready applicability to land areas, and its simple relation to the second-foot. A stream flowing at the rate of 1 cubic foot per second will discharge about 2 acre-feet, or more exactly, 1.9835 acre-feet, in 1 day of 24 hours. In 1 hour it will discharge about 1 acre-inch.

5. Measuring Devices.—The devices most used for measuring irrigation water are weirs, submerged orifices, and current meters, all these being accompanied by gages showing the stage or head of the water in the stream measured. Where there is sufficient available fall the weir is the most convenient and almost universal measuring device. Where there is less fall, and the quantity of water to be measured is small, some form of orifice can be used and is less affected by temporary variations of head than the weir, but must be kept free from trash.

Where the quantity of water is too large or the available head is insufficient for the use of the weir, a current meter gaging station may be employed, as described on page 158.

a. Weirs.—A weir may be defined as a wall over which a stream of water flows. Experiments have shown that where the conditions are well defined the quantity of water discharged over a weir bears a definite relation to the depth of the flow, and by keeping this constant, or by noting its variations, the quantity of water passing in a given time may be accurately measured. This relation, however, varies with the length, shape and other conditions concerning the weir. Weirs are of two general types, namely, free weirs and submerged weirs.

A *free weir* is one where the downstream water elevation is lower than the crest of the weir.

A *submerged weir* is one where the downstream water elevation is higher than the crest of the weir. A free weir is some-

times converted into a submerged weir by increasing the discharge sufficiently or by obstructing the stream below sufficiently to cause the downstream water elevation to rise above the level of the weir crest.

Where the sides of the weir are placed so as to contract the channel in which the weir is situated, it is called a contracted weir, and where the sides of the weir are coincident with the stream it is called a suppressed weir, the contractions being in this case suppressed.

When the sides of a weir are perpendicular to the crest, it is called a rectangular weir. In a trapezoidal weir, the sides make obtuse angles with the crest. A common form of trapezoidal weir is called the Cippoletti weir in which the sides slope outward from the crest in the ratio of 1 horizontal to 4 vertical. It is so designed in order that the ratio of the end contractions of the sheet of water to its depth shall be constant.

For the accurate measurement of water, weirs should be constructed with the following characteristics:

1. The crest and sides of the weir should be sharp and smooth, and should be distant from the bottom and sides respectively, both above and below the weir, not less than three times the depth of water on the weir.
2. The crest should be level from end to end.
3. The upstream face of the weir should be vertical.
4. Air should circulate freely under the overflowing sheet.
5. The cross-sectional area of the stream above the weir should be not less than seven times that of the overflowing sheet of water.
6. The depth of water on the weir should be not more than one-third its length.

The measurement of the head on the weir should be the actual elevation of the water surface above the weir crest, from 5 to 10 feet upstream from the weir. Where the surface velocity of the stream is more than 3 feet per second at a point upstream from the weir a distance of ten times the depth on the weir, or where the area of its cross-section is less than six times that of the overflowing sheet, a correction must be made

for velocity of approach, which increases the discharge over the weir.

From experiments on rectangular weirs, Francis developed the formula:

$$Q = 3.33H^{3/2}(L - 0.2H)$$

In which Q = the quantity discharged in second-feet;

L = the length of weir in feet;

and H = the head on the weir in feet.

The Cippoletti weir permits a simpler formula for the reasons above given, and Cippoletti's experiments indicated a slightly higher coefficient, resulting in the following:

$$Q = 3.367LH^{3/2}$$

Where conditions encountered indicate a velocity of approach sufficient to affect the result, this may be computed from the following formula:

$$V = \frac{Q}{A}$$

In which V = the velocity of approach;

Q = the discharge in second-feet;

and A = the area of cross-section of the channel of approach.

To adapt this to the formulæ, V should be converted to terms of head by the following formula:

$$h = 0.0156v^2$$

In which h = the head due to velocity of approach.

Where this results in a considerable value for h , that value may be substituted for h in the following formula proposed by Francis for cases requiring correction for velocity of approach:

$$Q = 3.33L[(H + h)^{3/2} - h^{3/2}]$$

The corresponding formula for Cippoletti weirs is:

$$Q = 3.367L(H + 1.5h)^{3/2}$$

Measuring Orifices.—Where the amount of floating débris is negligible or can be thoroughly controlled and the quantity of water to be measured is not too great, some form of orifice is perhaps the best and most accurate of the cheaper forms of canal measurement. It can be used with smaller loss of head than required for a weir, and the results are less affected by errors in observing the head. It is worthless, however, whenever it is liable to be clogged in any degree.

An orifice, as the term is here used, is any form of opening in the wall of a channel entirely below the surface of the contained water. The wall may have any position from horizontal to vertical, and the water may discharge either into water or into the open air. If it discharges into air it is said to be free. When it discharges into water, it is called a submerged orifice.

A contracted orifice has its perimeter located far enough from the bounding surfaces of the containing channel, so that the filaments of water approaching the orifice are sharply deflected in passing out, and by their inertia contract the issuing stream to a smaller diameter than that of the orifice.

A suppressed orifice has its perimeter so nearly coincident with the bounding surfaces of the channel of approach, as to eliminate this contraction. Between these limits are many degrees of partial contraction.

If the opening is cut in a wall of considerable thickness, or if a discharge tube is attached, it requires entirely different coefficients from a simple orifice.

The most suitable orifice for measurement is the vertical sharp-edged rectangular, contracted, submerged orifice. This type can be accurately reproduced and its discharge coefficient has been carefully determined.

The thin, sharp edges which form the boundaries of the orifice, must be at sufficient distance from the boundaries of the containing water prism, so that the filaments of water in passing out will have the maximum deflection from a straight line, as they enter the orifice, and thus cause the maximum contraction of the issuing stream. To accomplish this, the orifice must be

at a distance from the bounding surfaces of the prism, at least twice the least dimension of the orifice. The upstream face of the orifice should be vertical, and the sides should be vertical. The top and bottom edges of the orifice should be parallel and horizontal. The cross-sectional area of the water prism for 25 feet on each side of the orifice, should be at least six times the area of the orifice. The head on the orifice to be used in computation is the actual difference in elevation between the upstream and downstream water surfaces.

As irrigation channels are usually much wider than their depth, it is convenient to make measuring orifices longer than their height. To simplify computations it is well, if practicable, to have the cross-sectional area of the orifice an even number of square feet. A length of 2 feet with a height of 6 inches, for example, gives an area of 1 square foot, which is the most convenient area of all.

The formula for computing the discharge of the standard rectangular submerged orifice follows:

$$Q = 0.61\sqrt{2gHA}.$$

It will be noted that the discharge of the orifice varies with the square-root of the head, while that of a weir varies as the cube of the square-root of the head. For this reason the former is more accurate, especially under conditions where the head may be subject to temporary unrecorded fluctuations. For the same reason it requires considerably more velocity of approach to sensibly affect the discharge of an orifice, but when this is considerable, it may be allowed for by the following formula:

$$Q = 0.61\sqrt{2g(H+h)}A,$$

the symbols having the same significance as heretofore. This need seldom be used where the conditions of accuracy are properly met.

When it is necessary to place the orifice at the bottom of the channel or otherwise to suppress a portion or all of the contrac-

tion of the orifice, the discharge may be approximately obtained by the following formula:

$$Q = 0.61(1 + 0.15r)\sqrt{2gHA},$$

where r = ratio of the suppressed portion of the perimeter to the whole perimeter of the orifice, and the other symbols have the same significance as heretofore given.

The coefficients in this formula are not well determined, and cannot be made as exact as those in the standard orifice, which is more accurately reproducible.

Notwithstanding its theoretical accuracy, the uses of the orifice are limited in practice by three important conditions:

1. It is adapted only to small quantities of water.
2. Unless very large it is often liable to be partially clogged with débris, thus vitiating the results.
3. The necessity of observing both the upstream and downstream head.

For the first two reasons the weir is generally preferred where sufficient head is available and for this reason the free orifice is seldom used as this requires as much head as a weir; it may be convenient, however, in some cases where it is desired to measure a small quantity of water without trash.

Where the available fall for measuring a canal is too small, or the amount of sediment too great to permit good results from the use of weirs or orifices, it may be necessary to establish a current-meter gaging station. This should be located in a straight uniform section of the canal with clean stable banks and bed, where velocities are unaffected by drops, checks and turnouts, or any other influence likely to affect the relation of gage height to discharge, upon the constancy of which relation the value of the results will largely depend.

The essential elements of the observations are frequent or continuous records of the gage height at the station, and careful measurements of discharge taken at various stages of canal height, to indicate points of control by which a curve may be plotted which shall show for all stages, the relation of gage height to discharge.

The best provision for current-meter measurements is a bridge spanning the canal without any disturbance of the flow by piers or abutments. This should be divided into permanently marked sections of 10 feet for large canals, and less intervals for small ones. At each station the depth and velocity are carefully measured, and an assumption made that each measured result is the mean for equal distances on each side thereof, so that each measurement represents one of the sections. The velocity in feet per second, multiplied by the depth in feet, multiplied by the width of the section, will give the discharge in second-feet of that section, and the sum of the discharges of all the sections will be the discharge of the canal.

As a temporary makeshift the velocity of the canal may be measured by means of floats, but where measurements are to be made frequently, both accuracy and economy require that the current meter should be employed. The meters and their use are described on page 157.

Whether measurements are made on weirs, orifices or with current meters, they require records of gage height in order to determine the discharge. In a canal wherein the discharge is kept practically constant, it is sufficient to read the gage twice a day, with additional readings whenever the quantity of water flowing is changed. Where changes are frequent, either from changing the position of the headgates or from changes in the quantities taken out by laterals, an automatic instrument should be employed to make a continuous record.

Various forms of water meters have been extensively used where greater accuracy is required than can be obtained with weirs and orifices, or where conditions make their use convenient. In general they are too expensive for practical application to the measurement of irrigation water, except where this is very valuable.

Where a small quantity of water is delivered through pipes, the ordinary water meter used for city supplies is the most convenient and suitable. It consists of a set of blades caused to revolve by the passing water, and an indicator recording the revolutions of the blades.

When mechanically perfect they are very accurate, but they are too complicated and expensive for irrigation use, and are not suitable for measurement of the large quantities of water required in irrigation.

The rate of discharge through the weirs and orifices described depends upon the head of water above, and in the cases of submerged weirs and orifices, the elevation of the water below must also be known. It thus becomes necessary to keep a record of these elevations, and this attention is the principal part of the cost of water measurement by these methods. If the gages are read only at intervals by an observer, no account is had of fluctuations between observations, and serious inaccuracies may be involved. Devices are therefore employed to make and keep a continuous automatic record of the gage

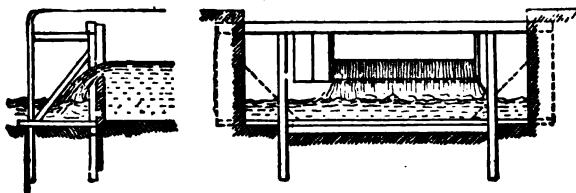

FIG. 54.—Rectangular Measuring Weir.

height, and these again involve expense, and complicated clockwork and recording apparatus liable to disarrangement, and requiring considerable skill for repair. Several recording devices of reasonable simplicity and efficiency are obtainable from instrument makers, all dependent upon the rise and fall of the water as indicated by a float controlling a pen on a dial or cylinder driven by weights and regulated by clockwork.

c. Hanna Meter.—F. W. Hanna has invented a recording device designed not only to record the height of the water but to translate this into discharge and to give the results in acre-feet, which it indicates on a counter. This machine is also controlled by a float, driven by weights and regulated by clockwork. Its advantage over the standard automatic gage is that it eliminates the need of using a table for interpreting the record. It is however, more complicated, of course.

To obviate the necessity of keeping and recording gage heights, and also to secure uniformity of flow, various devices have been proposed to keep the head constant over weirs or orifices, some of which are in limited use.

d. The Azusa hydrant is simply a series of submerged orifices of different sizes which may be opened or closed at will, in accordance with the quantity of water desired. To keep a

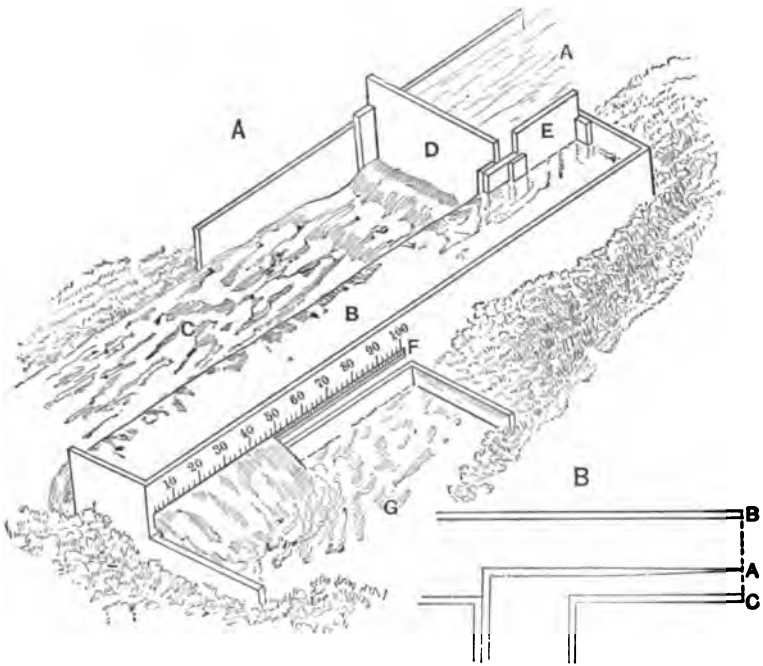

FIG. 55.—Foote's Measuring Weir, A. Water Divisor, B.

constant head, a weir is provided in the canal just below the hydrant, and an opening in this so adjusted as to keep the water in the canal just above the crest of the weir. If the weir is made with very long crest, any rise of water in the canal will mostly pass over the weir, but will also somewhat increase the discharge through the orifices.

e. The Foote Measuring box is a device adjustable to cause any desired quantity of water to flow nearly constantly, and so

arranged as to measure this in miner's inches. It consists of a box flume fitted into the ditch from which the water is to be measured. This flume is divided longitudinally into two compartments of unequal sizes, and the entrance of water into each is controlled by flash boards, so that in use, the water stands 3 or 4 inches higher in the small compartment than in the large one. The small compartment is closed at the lower end, and provided with a spillway into the large one, over which the water flows when it reaches a certain depth. On the opposite side of the small compartment is a long horizontal slot 4 inches high, the center of which is 4 inches below the crest of the spillway, and closed by a gate sliding horizontally, adjustable to a scale, so that the opening may be adjusted to any length from zero up to the entire length of the slot. The area of the opening in square inches is thus four times the length of the opening as adjusted, and when the water stands at the crest of the spillway, or 4 inches above the center of the slot, the area of the opening expresses the discharge in miner's inches. The successful use of this measuring device requires the loss of 4 or 5 inches of head in the supply lateral, and about a foot into the receiving lateral. It is therefore not adapted to use where such heads are not available, but is otherwise convenient and reasonably accurate.

Many similar devices have been proposed and used to some extent, which are merely more or less ingenious combinations of weirs and orifices, some of which are described in detail in Bulletin No. 247 of the Agricultural Experiment Station of Berkeley, California.

All such weirs and orifices require considerable loss of head and a great deal of attention to the stage of water, involving an automatic time register if any great accuracy is required. To avoid these objections, several devices have been invented to measure the quantity of water more directly, without so much loss of head, and with increase of simplicity of mechanism.

f. The Dethridge meter is a paddle wheel consisting of a drum on a horizontal axle, with projecting blades of metal attached at equal intervals to the periphery of the drum, revolving in a

box or flume, in which it fits closely without touching, so that very little water can pass without moving the blade and turning the wheel. The bottom of the box is curved to correspond to the circular path of the blades, so that in passing, a blade does not leave the proximity of the bottom until the next blade reaches it, and so that in use, the water always fills the box up to the bottom of the drum.

By recording the revolutions of the wheel, information is obtained which can be readily translated into terms of flow. The axis of the wheel can be attached directly to a counter by reading which the revolutions are obtained, and by multiplying the velocity thus obtained by the cross-section of the space through which the water passes under the drum, the discharge is obtained directly, affected, however, by the leakage past the vanes, which in turn is affected by the friction involved in turning the wheel. A well-made instrument of this kind is very accurate, and measures the water with a very slight fall, depending on the quantity passing. It will give satisfactory results with quantities varying between maxima and minima in the ratio of 5 to 1. In practice the box, if of wood, is liable to warp slightly, and thus vary the clearance around the blades, or the friction of turning, or both, which changes the coefficient of discharge. For this reason, the direct method of inferring the discharge from the cross-section and wheel readings is sometimes rather rough and it is better to have a rating for the coefficient of discharge by actually measuring the discharge at the various stages. This rating should be renewed whenever conditions change perceptibly. It is best to construct the box surrounding the wheel of rich concrete carefully smoothed, and if this be properly founded, little change need be expected. This meter can be built of any size desired. It is moderate in cost, is extremely simple in principle, in construction and in operation. It gives satisfactory results, with very small loss of head, but requires attention to prevent interruption if much floating drift is passing.

g. The Hill meter, devised by Louis C. Hill, consists of a short box or pipe in the form of an inverted siphon, through

which the water to be measured is made to pass, the issuing end being vertical and lower than the other and somewhat smaller. As the water rises through the issuing end of the siphon, it passes a set of inclined vanes attached to a central drum revolving on a pivot, and the flowing water striking the inclined vanes turns the drum, the axis of which drives a counter so arranged on a dial as to register the passing water directly in acre-feet. A single opening and meter can be used with an accuracy of about 2 per cent, over a range from 1 minimum to 5 maximum.

Unless the entrance of the siphon is well screened the meter is liable to be choked by floating weeds or other drift.

When kept free from drift and properly built, this meter is very accurate, reliable and simple. It requires very little loss of head in the measured water.

h. The Grant-Mitchell or Australian meter is used to some extent in Australia, and is similar in principle to the Hill meter. It is, however, more expensive, and seems to have no special advantages over that instrument, but is said to give good results. Both are patented.

i. The Venturi meter is a very simple and accurate device for measuring water, much used on city water supply, and recently introduced to some extent on irrigation works.

The water is conducted under pressure through a pipe which is gradually and gently contracted, and then still more gradually returns to its normal dimensions. In passing through the contracted throat, the velocity of the water is increased in the same ratio that the cross-section of the pipe is diminished. By this means a portion of the pressure head is converted into velocity head, and by measuring the pressure at a point before contraction begins,

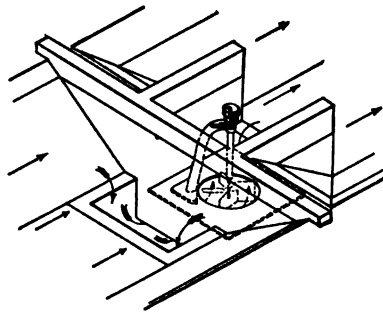

FIG. 56.—Australian Water Meter.

and also at the contracted throat, the quantity of water passing may be computed from the following formula:

$$Q = Ca \sqrt{\frac{2gh}{1 - \left(\frac{a}{A}\right)^2}}$$

in which a = the area at the throat;
 A = area of the pipe before contraction;
 h = pressure head at A – same at a ;
 C = a coefficient usually from .97 to .99, dependent on the perfection of the meter.

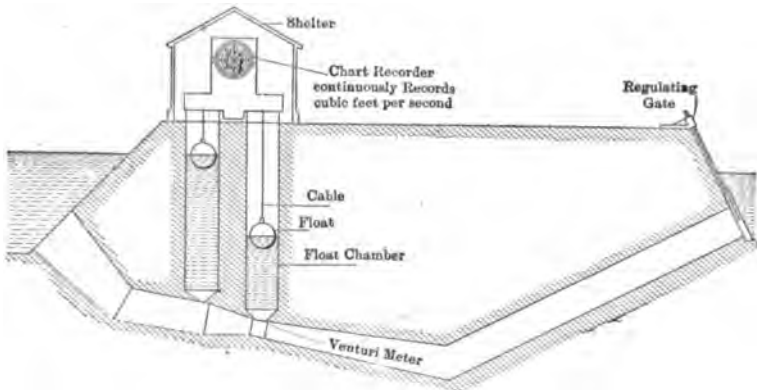

FIG. 57.—Venturi Meter and Recording Device on Lateral Head.

The only complication about this meter is the measurement and registration of the pressures, a and A . Elaborate electric devices are sometimes used for this, which are very accurate but too expensive for irrigation uses. Floats can be used in connection with the ordinary automatic gages, which will give approximate results if kept in order.

j. Venturi Flume.—Mr. D. C. Henny has proposed a simple and cheap modification of the Venturi meter, called the “Venturi Flume.” In this flume a contraction is effected by a curved metal or reinforced concrete sheet placed between the sides of the flume, depressing the surface of the water. At the point of greatest depression the sheet is for a few inches parallel

with the floor of the flume and is pierced by several holes allowing water to rise above the sheet. One gage is installed in the flume above the measuring device, and the second one in the still water pond formed by the curved sheet and the sides of the flume. From the reading of these two gages " H " is found, from which the flow may be calculated by the above formula.

The device was tested in 1915 in various forms on four projects of the Reclamation Service, the flow being checked by weir measurements. The quantity of water varied in these experiments between 1 second-foot and 7 second-feet, and the throat velocity from 1 to $8\frac{7}{8}$ feet per second. These showed deviations from correct results varying from about 1 to about 11 per cent of the quantity of water measured, the more accurate results being generally obtained with the larger quantities of water.

The loss of head through the throat varies between .03 foot and .05 foot, being greater for the higher velocities and for the smaller quantities of water. The loss varied from 13 per cent to 56 per cent of the velocity head.

Losses exceeding 40 per cent of the velocity head at the throat occur only for height of throat less than 3 inches. With a throat height of 4 inches or over the losses are from 24 per cent down, the tendency being to a reduction of percentage as the velocity increases, although the actual loss of head may be greater.

This measuring device, especially in the smaller sizes, is liable to clog with large weeds, but passes leaves and other small trash. It has not been commercially manufactured.

In 1915 Mr. V. M. Cone of the United States Department of Agriculture designed and experimented with another form of "Venturi Flume" in which contraction is effected by drawing in the sides of the flume, leaving the water surface free. Experiments on this type of flume were made in connection with some of those of the Henny flume above described. The experiment showed that below a flow of 2 second-feet the coefficient fluctuates erratically with unreliable results. Above this amount the

TABLE XXVII.—DISCHARGE OF STANDARD RECTANGULAR SUB-MERGED ORIFICES IN CUBIC FEET PER SECOND, COMPUTED FROM THE FORMULA $Q=0.61\sqrt{2gH} \cdot A$

Head <i>H</i> , Feet	Cross-sectional Area <i>A</i> of Orifice, Square Feet							
	0.25	0.5	0.75	1.0	1.25	1.5	1.75	2.0
0.01	0.122	0.245	0.367	0.489	0.611	0.734	0.856	0.978
0.02	0.173	0.346	0.518	0.691	0.864	1.037	1.210	1.382
0.03	0.212	0.424	0.635	0.847	1.059	1.271	1.483	1.694
0.04	0.245	0.489	0.734	0.978	1.223	1.468	1.712	1.957
0.05	0.273	0.547	0.820	1.093	1.367	1.640	1.913	2.186
0.06	0.300	0.599	0.899	1.198	1.497	1.797	2.097	2.396
0.07	0.324	0.647	0.971	1.294	1.617	1.941	2.265	2.588
0.08	0.346	0.691	1.037	1.383	1.729	2.074	2.420	2.766
0.09	0.367	0.734	1.101	1.468	1.835	2.201	2.638	2.935
0.10	0.387	0.773	1.160	1.557	1.933	2.320	2.707	3.094
0.11	0.406	0.811	1.217	1.622	2.027	2.433	2.839	3.244
0.12	0.424	0.847	1.271	1.694	2.118	2.542	2.965	3.389
0.13	0.441	0.882	1.323	1.764	2.205	2.645	3.086	3.527
0.14	0.458	0.915	1.373	1.830	2.287	2.745	3.203	3.660
0.15	0.474	0.947	1.421	1.895	2.369	2.842	3.316	3.790
0.16	0.489	0.978	1.467	1.956	2.445	2.934	3.423	3.912
0.17	0.504	1.008	1.512	2.016	2.520	3.024	3.528	4.032
0.18	0.519	1.037	1.556	2.075	2.593	3.112	3.631	4.150
0.19	0.533	1.066	1.599	2.132	2.665	3.198	3.731	4.264
0.20	0.547	1.094	1.641	2.188	2.735	3.282	3.829	4.376
0.21	0.561	1.120	1.681	2.241	2.801	3.361	3.921	4.482
0.22	0.574	1.148	1.722	2.296	2.870	3.464	4.018	4.592
0.23	0.587	1.172	1.759	2.345	2.931	3.517	4.103	4.690
0.24	0.600	1.198	1.797	2.396	2.995	3.599	4.193	4.792
0.25	0.612	1.223	1.834	2.446	3.057	3.668	4.280	4.891
0.26	0.624	1.247	1.871	2.494	3.117	3.741	4.365	4.988
0.27	0.636	1.270	1.906	2.541	3.176	3.811	4.446	5.082
0.28	0.646	1.294	1.942	2.580	3.236	3.883	4.530	5.178
0.29	0.659	1.319	1.978	2.638	3.297	3.956	4.616	5.276
0.30	0.670	1.339	2.009	2.678	3.347	4.017	4.687	5.356

TABLE XXVII.—Continued

Head <i>H</i> , Feet	Cross-sectional Area <i>A</i> of Orifice, Square Feet							
	0.25	0.5	0.75	1.0	1.25	1.5	1.75	2.0
0.31	0.681	1.363	2.045	2.726	3.407	4.089	4.771	5.452
0.32	0.692	1.382	2.073	2.764	3.455	4.146	4.837	5.528
0.33	0.703	1.405	2.107	2.810	3.513	4.215	4.917	5.620
0.34	0.713	1.426	2.139	2.852	3.565	4.278	4.991	5.704
0.35	0.724	1.446	2.169	2.892	3.615	4.338	5.061	5.784
0.36	0.734	1.467	2.201	2.934	3.667	4.401	5.135	5.868
0.37	0.745	1.488	2.232	2.976	3.720	4.464	5.208	5.952
0.38	0.754	1.508	2.262	3.016	3.770	4.524	5.278	6.032
0.39	0.764	1.527	2.291	3.054	3.818	4.582	5.345	6.109
0.40	0.774	1.547	2.321	3.094	3.867	4.641	5.415	6.188
0.41	0.783	1.567	2.350	3.133	3.917	4.700	5.483	6.266
0.42	0.792	1.585	2.377	3.170	3.962	4.754	5.547	6.339
0.43	0.802	1.604	2.406	3.208	4.010	4.812	5.614	6.416
0.44	0.811	1.622	2.433	3.244	4.055	4.866	5.677	6.488
0.45	0.820	1.640	2.461	3.281	4.101	4.921	5.741	6.562
0.46	0.829	1.659	2.489	3.318	4.147	4.977	5.807	6.636
0.47	0.839	1.678	2.517	3.356	4.195	5.035	5.874	6.713
0.48	0.847	1.695	2.542	3.389	4.237	5.084	5.931	6.778
0.49	0.856	1.712	2.568	3.424	4.280	5.136	5.992	6.848
0.50	0.865	1.729	2.594	3.458	4.323	5.188	6.052	6.917
0.52	0.882	1.763	2.645	3.527	4.409	5.290	6.172	7.054
0.54	0.898	1.797	2.695	3.593	4.491	5.390	6.288	7.186
0.56	0.915	1.830	2.745	3.660	4.575	5.490	6.405	7.320
0.58	0.931	1.862	2.794	3.725	4.656	5.587	6.518	7.450
0.60	0.947	1.895	2.842	3.790	4.737	5.684	6.632	7.579
0.62	0.963	1.925	2.887	3.850	4.812	5.775	6.737	7.700
0.64	0.978	1.956	2.934	3.912	4.890	5.868	6.846	7.824
0.66	0.993	1.987	2.980	3.974	4.967	5.960	6.954	7.947
0.68	1.008	2.016	3.024	4.032	5.040	6.048	7.056	8.064
0.70	1.023	2.046	3.069	4.092	5.115	6.138	7.161	8.184
0.72	1.038	2.076	3.114	4.152	5.190	6.228	7.266	8.304
0.74	1.052	2.104	3.158	4.210	5.260	6.311	7.369	8.421
0.76	1.066	2.132	3.198	4.264	5.330	6.396	7.462	8.528
0.78	1.080	2.160	3.240	4.320	5.400	6.480	7.560	8.640
0.80	1.094	2.188	3.282	4.376	5.470	6.564	7.658	8.752

accuracy is about the same as that for the Henny flume. It has the disadvantage that the formula by which the flow is to be calculated must take into account not only " H " but also separately the depth at either of the two gages. Stilling boxes are necessary with high velocities to permit accurate observations of the surface of the swiftly flowing water. It has the advantage, however, of being less easily clogged with drift, as the upper surface is free from obstruction.

The successful and practical meter for measuring water to each farm must be both simple and cheap. It is used so frequently that any complication or trouble with each one aggregates a large amount and hence the importance of simplicity and reliability. This extends also to the formula for computing results. It is important to have these computations worked out and tabulated for all possible cases, not only for convenience and economy of time, but also to eliminate liability to errors.

One of the greatest economies possible in the measurement of water is the use of the rotation system, by which each irrigator takes a much larger quantity of water than he would be entitled to continuously, and shortens the time of use proportionately, allowing his neighbors to do the same. By this means it is necessary to measure the quantity used by all those who rotate together, and the length of time this volume is received by each indicates the total quantity each receives. This reduces the number of measurements to be made by meter, and is more accurate than meter measurements to individuals, as the time of delivery to each user can be easily determined to a second if desired, which is a much closer measurement than any meter measurement. This is one of the minor advantages of the rotation system.

In the present state of the art, the weir, either rectangular or Cipolletti, is the most practicable meter for irrigation purposes. If great accuracy is required, the mechanical register is employed to record the head, and if the forebay is kept clean good results are obtained.

REFERENCES FOR CHAPTER XI

- CARPENTER, L. G. Measurement and Division of Water. Bulletin No. 27, State Agricultural College. Fort Collins, Col., 1894.
- CHURCH, IRVING P. Mechanics of Engineering: Fluids. John Wiley & Sons, New York.
- FANNING, J. T. Hydraulic and Water-supply Engineering. D. Van Nostrand & Co., New York, 1890.
- FLINN, A. D., and DYER, C. W. D. The Cippoletti Trapezoidal Weir. Trans. Am. Soc. C. E., Vol. XXXII. New York, July, 1894.
- FLYNN, P. J. Irrigation Canals and Other Irrigation Works, and Flow of Water in Irrigation Canals. Denver, Col., 1892.
- GREEN, J. S. Fourth Biennial Report State Engineer of Colorado. Denver, Col., 1889.
- HORTON, ROBERT E. Weir Experiments, Coefficients and Formulas. U. S. Geological Survey, Water Supply Paper No. 200. Washington, D. C., 1907.
- HOYT, J. C., and GROVER, N. C. River Discharge. John Wiley & Sons. New York, 1907.
- MULINS, Lieut.-Gen. J. Irrigation Manual. E. & F. N. Spon, New York, 1890.
- MURPHY, E. C. Accuracy of Stream Measurements. U. S. Geological Survey, Water Supply Paper No. 94. Washington, D. C., 1904.
- MURPHY, E. C., HOYT, J. C., and HOLLISTER, G. B. Hydrographic Manual, U. S. Geological Survey, Washington, D. C., 1904.
- NEWELL, F. H. Part II, 11th and 13th Annual Reports U. S. Geological Survey, Washington, D. C., 1890 and 1892.
- WEISBACH, P. J. Hydraulics and Hydraulic Motors. Translated and Edited by A. Jay Du Bois. John Wiley & Sons, New York, 1891.
- HANNA, F. W. Measurement of Water for Irrigation, U. S. R. S. Handbook.
- DRAKE, E. F. Report of Hydrometric Surveys for 1916, Dept. of Interior, Ottawa, Canada.
- SCOBAY, F. C. Flow of Water in Irrigation Channels. Bulletin 194, U. S. Office of Experiment Stations.
- CONE, V. M. The Venturi Flume. Journal of Agricultural Research, Vol. IX, No. 4. Washington, D. C.
- MEAD, DANIEL W. Water Power Engineering. McGraw-Hill Book Co., New York.
- BARK, DON H. Experiments on the Economical use of Water in Idaho. Bulletin 339, U. S. Office of Public Roads and Rural Engineering.
- Some Measuring Devices used in the Delivery of Irrigation Water. Bulletin 247, Agr. Exp. Sta., University of California, Berkeley, Cal.
- MORITZ, E. A. Flow of Water in Pipes. Eng. Record, Vol. LXVIII, page 667.

CHAPTER XII

DRAINAGE

FOR the health and vigor of the most useful plants, the roots require air just as certainly as they require water. If the soil in the root zone is saturated with water this excludes the air, and if this continues for any considerable length of time the plant suffers and eventually, unless this is corrected, it dies. There is much difference in the rapidity with which various plants are so affected, and a few water-loving plants require their roots to be in saturated soils for the best results. The tules, rushes, water grasses and willows are the commonest spontaneous growths of this kind, and several varieties of coarse grasses also thrive in wet places. The principal useful plants which grow best in saturated ground are rice, cranberries, and some varieties of dates.

It is difficult in most localities to apply to the surface of the land in irrigation, sufficient water for the maximum crop production, without allowing a considerable quantity of the water applied to escape to the underlying water table. In addition to this, every irrigated region is traversed by numerous canals and laterals, continually wet during the irrigation season, from which water steadily percolates downward to the water table in considerable quantity unless the canals are well lined with concrete.

For these reasons it generally occurs that after a large valley has been irrigated for a few years, the ground water begins to rise, and unless there is free escape through coarse subsoils to deep drainage lines, the water table rises to a point where it injures vegetation, and wherever it continues to rise, it eventually kills all vegetation except aquatic, or water-loving plants. This generally occurs first in low places, and ponds and marshes

are apt to form which gradually increase in area unless means are taken to prevent or cure the trouble. This result is so universal that there is scarcely a large valley in the world that has been irrigated for several years that does not have trouble with seepage, and a problem of drainage. In many places this result is wide-spread and disastrous.

It is said that large areas in India, formerly subject to occasional famines caused by failure of crops on account of drouth were relieved by irrigation works to counteract the drouths only to find that the mortality from malaria induced by the marshes resulting from irrigation was greater than that formerly due to famine. Large areas in Egypt have been abandoned on account of the rise of ground water and accompanying alkaline conditions.

In the Murgab Valley in Turkestan the irrigated lands have been largely abandoned on account of the rise of water and alkali, and the canals built to new lands.

Large areas in the Valley of California have had their fertility reduced or destroyed from the same cause.

In the San Luis Valley of Southern Colorado, where irrigation has been widely practiced, nearly 400,000 acres of land have been waterlogged.

The Rio Grande Valley in New Mexico and Texas shows extensive results of high water table and alkali.

Many of the projects recently built by the U. S. Reclamation Service already show similar problems which have been or are being met by the construction of drainage works.

It is thus evident that the subject of drainage and swamp reclamation is a necessary branch of irrigation engineering and should be studied as such.

1. Signs of Seepage.—No definite rules can be formulated to indicate where seepage is likely first to appear or to develop as irrigation proceeds. A careful study of soil and topographic conditions may furnish evidence to indicate whether seepage is likely to occur, but it is seldom that the movements of ground water can be foretold with any certainty, and trouble is often experienced where least expected. For this reason it is impracti-

cable to wisely plan and construct drainage works for irrigated lands in advance of their actual irrigation.

It is nevertheless very important that the rise and movement of the ground water be closely observed from the time that irrigation begins, for the rising water will bring alkali to the surface if any is available in the soil, and the longer this accumulates, the longer it will require to reclaim the lands and the greater will be the expense thereof. The first surface evidence of a dangerous rise of ground water may be a temporary increase in crop production induced by the abundant and constant water supply not yet excessive. Numerous cases have occurred where the rising water table has produced large crops, and the continuing rise as the crops matured has so softened the ground as to render it too boggy to permit machinery to harvest the crop. Usually, however, the progress is much slower than this. In order to have proper warning of the approach of dangerous seepage, it is necessary to keep close observation on the position of the ground water by means of wells located at suitable intervals over the irrigated tract. It is usually found that there is an annual oscillation of the water level, which rises during the irrigation season and begins to decline slowly soon after the water is shut out of the canals. If this decline is each year back to the level at which it began the irrigation season, and this level is not too high, it may be that the ground water has ample escape to neighboring drainage lines through the subsoil. Its movements should be carefully watched, however.

Fig. 58 shows the fluctuation of ground water in the Rio Grande Valley, New Mexico, and its relation to the application of water in irrigation. The ground-water curve is a composite showing averages in twenty representative wells scattered over an area of 8500 acres. The net irrigated area was 5300 acres, on which the average seasonal application was 4.3 feet in depth, which would cover the gross area of 8500 acres to a depth of 2.7 feet.

Fig. 59 shows the seasonal fluctuation and continual yearly rise of ground water in an irrigated section of the Boise Valley, Idaho. Fig. 60 shows for another portion of the Boise Valley, the fluctuation of the water table before and after drainage.

Moisture rises above the water table by capillary attraction, the height to which it will thus rise varying from a foot in sandy soil, to a maximum of 8 feet in clay. When the capillary water

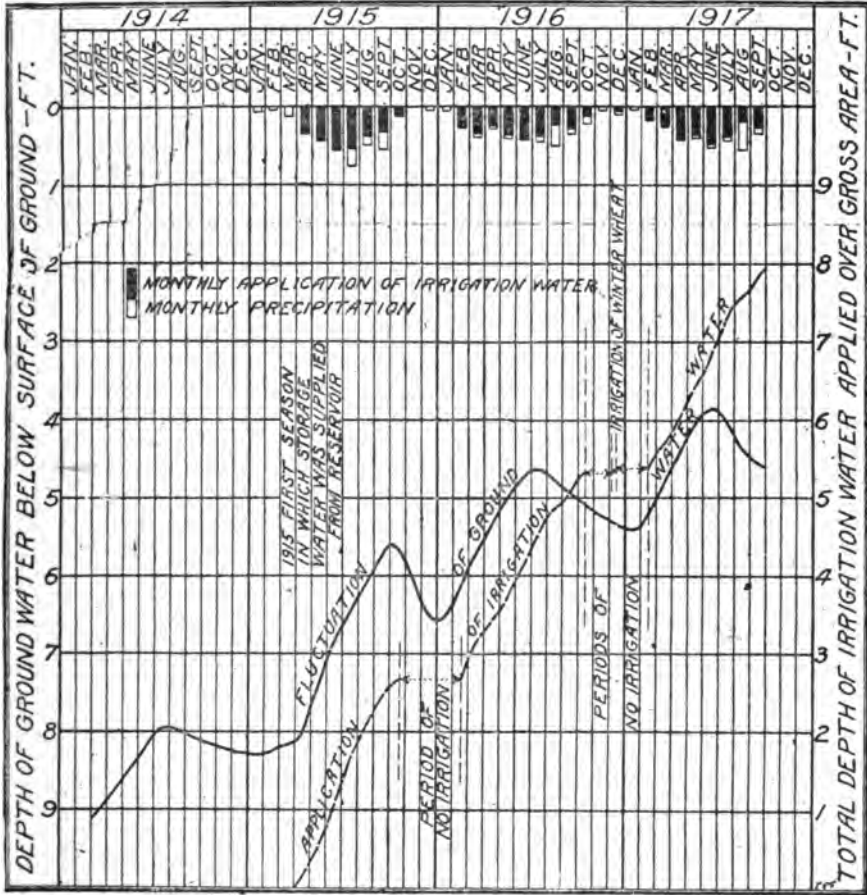

FIG. 58.—Curve Showing Fluctuation of Ground Water and Application of Irrigation Water in the Rio Grande Valley. After Burkholder.

approaches the surface, evaporation takes place, and in coarse soil this may prevent moisture from showing on the ground until the water table actually reaches the surface. When this happens free water will appear in pools, unless the rate of seepage

is less than the evaporation, in which case the free water does not appear although the water table may be practically at the surface.

By taking frequent and careful observations of the position of ground water it is possible, in most cases, to predict the injury of the land. These observations also serve another useful purpose. An accurate knowledge of the ground-water level

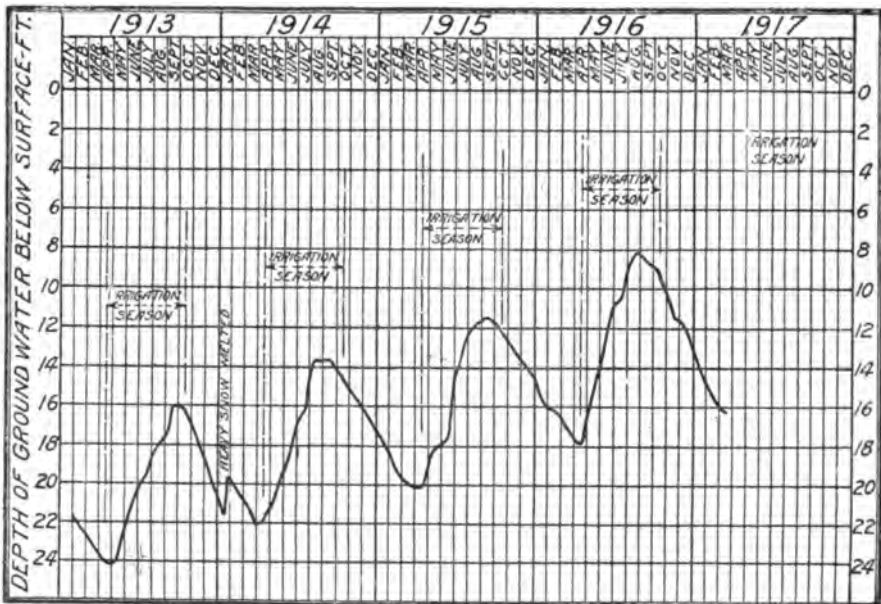

FIG. 59.—Curve Showing the Seasonal Fluctuation and Rise of Ground Water in Boise Valley, Idaho. After Burkholder.

over a considerable tract may indicate the movements of the water, by applying the simple rule that water tends to flow down hill, the slope of its surface showing the direction of flow. This knowledge will often show the origin of much of the seepage, and suggest means of cutting off the supply by providing intercepting drains. Alluvial streams with shallow channels often feed the water table as shown by its response to the rise and fall of the stream. If the subsoil be coarse, this response may be quick and complete, but there is always a lag

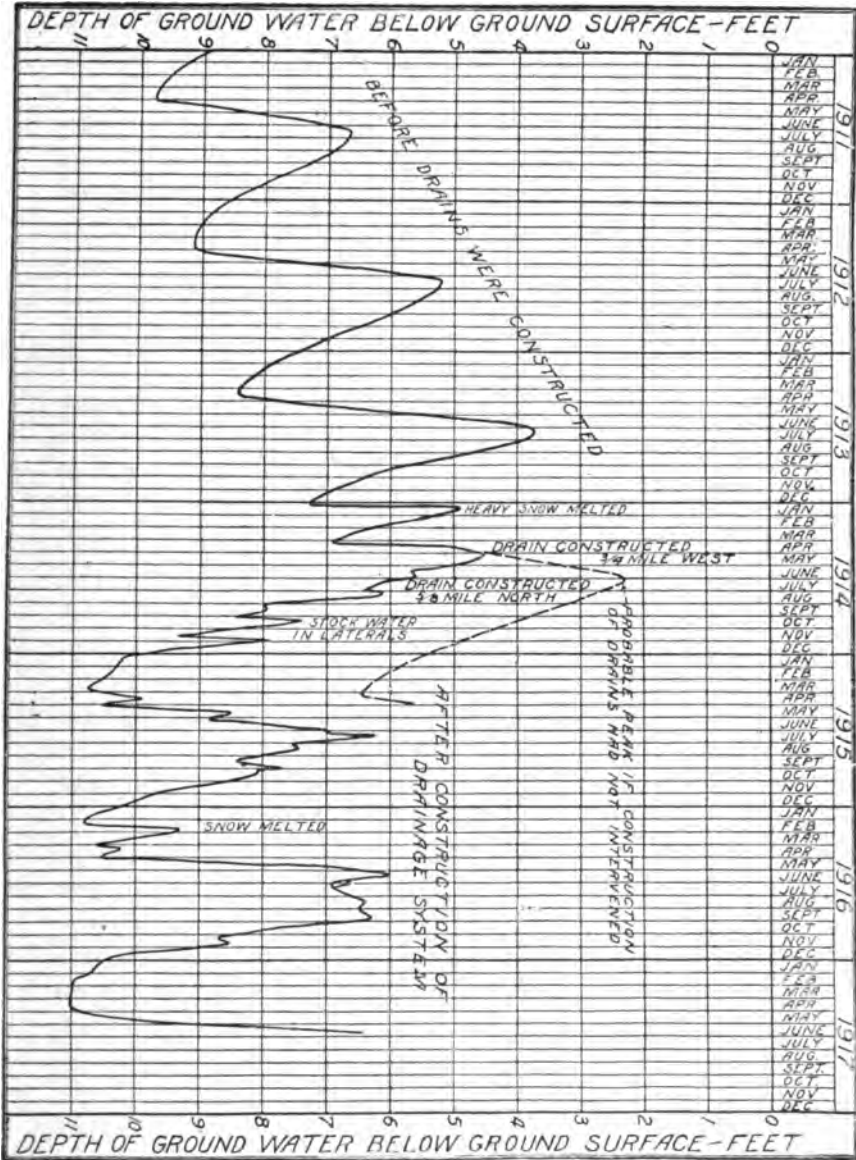

FIG. 60.—Curve Showing Rise of Ground Water before Construction of Drains and Effect of Drains at Considerable Distance in Lowering and Keeping it Below the Danger Point. Record from a well in a drained district of the Boise Valley, Idaho.

in time and elevation. That is, a water table controlled by a stream never reaches so high a maximum elevation as the stream, and reaches its culmination at a later date than that of the stream. Where this maximum is so high as to injure vegetation, it may be necessary to install an intercepting drain near and parallel to the river. The same conditions are sometimes fulfilled by a canal. In fact the canals and laterals always contribute a considerable portion of the seepage water unless they are lined with concrete, and where water users are reasonably careful in the application of the water in irrigation, the canals and laterals in open soils may contribute the major part of the seepage water. On the other hand, if water is lavishly applied in irrigation, its contribution to the ground water may greatly exceed the seepage from canals. It is important to ascertain the source of seepage water.

Where the soil is fine-grained and the water table remains permanently 4 to 6 feet below the surface, the capillary action may keep the soil moist in the root zone, and good crops may be produced by means of the ground moisture without surface irrigation. If the soil contains injurious salts, however, the constant rise of water from below and its evaporation from the surface will accumulate those salts at or near the surface in the soil occupied by plant roots, gradually injure the soil, and eventually make it perhaps entirely barren.

The rise of alkali is sometimes the most serious phase of the seepage problem. In an arid region nearly all except very coarse soils contain alkaline salts and a high water table is sure to bring these toward the surface. If the salts are abundant the destruction of fertility may follow closely after the rise of the seepage, and accumulate in the upper strata of soil in such quantity as to make the reclamation of the land a long and expensive process.

The remedy is to provide drainage followed by irrigation. By the former the water table is lowered, and the irrigation water applied to the surface and descending to the water table is carried off through the drains. In this journey downward through the soil it carries the alkali in solution, and it is dis-

charged through the drains. The effort, therefore, must be to reverse the upward movement of water, and produce conditions by which it will move from the surface downward, carrying the salts with it.

2. Classification of Drains.—With respect to their functions, drains may be divided into two classes:

1. Relief drains, or those furnishing ready escape for ground water to the most available natural drainage line, in order to lower the water table. They are generally built on the lowest available ground.

2. Intercepting drains, or those designed to intercept seepage waters between their source and the lands to be protected. They are often built on higher ground than the land they are designed to protect, but may also serve as relief drains for the lands above them.

These two classes of drains are by no means distinct, and the two functions are often combined to some extent in both.

With respect to their form, drains are of two classes:

1. Open drains are those designed to act as open channels, to traverse the water table and conduct the surplus water away.

2. Closed drains consist of tiles laid end to end in a channel in the water table and covered with earth, so that farming or other operations can proceed over the ground without disturbing the action of the drains.

Where they will answer the purpose, closed drains are of course preferable, but their use is restricted by their limited capacity and their cost. Where the slope of the country limits the grade available for the drain to a very moderate amount, the tile drain, restricted by the size of the tile, carries only a small amount of water, unless the tile be made very large. The sizes most commonly used as main drains are 10 inches and 12 inches in diameter, but larger sizes up to 18 inches in diameter are sometimes employed. Above 18 inches in diameter the standard tile sometimes fails under the overburden of 10 or 12 feet of soil, and larger sizes than 18 inches are seldom used except when made extra heavy for this purpose, in which case they are very expensive. Where the capacity of an 18-inch



FIG. 61.—Excavating Trench for Tile Drain, Montana.



FIG. 62.—Dragline Excavator on Drainage Work, Idaho.

tile is insufficient, it is generally best to build an open drain, if practicable.

3. Design of a Drainage System.—The work of designing such a system of drains as to remove the menace of a high water table and of rising alkali, and to leach from the upper strata of soil the accumulations of alkali, in the most effective and economical manner, is generally complicated, and requires long and close study of the positions and movements of both surface and ground water over several years. Moreover, this study must continue until the construction of the drainage system has been practically completed, so as to note the effect of drains after they are in service, and correct any errors of assumption that may have been involved in the original plan. Every such plan should therefore be considered tentative, and subject to modifications as the work progresses.

4. Location of Drains.—To decide the position and direction of the drains to be built, it is important to know the various sources of the seepage water, and also to know the surface topography and underground structure of the land to be drained.

In the treatment of underground waters, page 45, it is shown that the flow of percolating water varies with the slope of its surface. Also that the movement of water on a given grade is many times more rapid through sand and gravel than through clay or loam having smaller openings between the particles. Hence, if a drain be located entirely in a fine-grained soil like clay, it can lower the ground water only a very short distance back from the drain; for no considerable quantity of water can travel through the clay soil except on a steep grade, and this brings the gradient quickly to the level of the water table.

Therefore, if a drain is to be effective, it is necessary that it shall tap a stratum of sand or gravel, or at least some medium through which water can travel with reasonable velocity on a slight gradient. It frequently happens that a clay or loam soil needing drainage extends to a depth too great for a drainage ditch, and although the water table may stand several feet above the bottom of the ditch, it will drain only a few rods

on each side owing to the steep gradient maintained by the percolating waters in the tight soil.

In such case, relief is often found by boring wells at frequent intervals in the bottom of the drain until a coarser stratum is tapped, and in these wells the water rises from the open stratum into the drain and flows away. This draws on the ground water from a distance, and lowers the water table accordingly. Whenever such an open stratum is situated under an irrigated region, it receives the gravity water from the soil above, and conducts it down the slope frequently under tighter soils, and having insufficient outlet for all the water it can carry, accumulates pressure equal to the hydrostatic head of its source of supply minus the loss of head due to friction. Acting under this head, it percolates upward through the overlying clay and loam and waterlogs the land, which may not have been irrigated at all.

This roughly describes many artesian basins, which are located in "cieneegas," or swamps formed in this manner. The hydrostatic head may be insufficient to bring the water to the surface of the ground but ample to cause it to flow into the bottom of a drain if a well be provided as an outlet.

The foregoing illustrates the need of a thorough knowledge of the subterranean structure of the country to be drained, in order that the drains may be so located as to take advantage of water-bearing materials that may be available to a properly located drain.

It is important to build closed drains on as steep a grade as possible in order to increase their discharge capacity and to keep them clear of detritus. Whether a drain be open or closed it is usually desirable to give it all the grade available. In the case of the open drain, a good velocity tends to keep it scoured out, and to prevent the growth of aquatic plants which are the bane of drainage ditches. A sluggish velocity not only encourages aquatic growth, but it promotes clogging by other means. Tumble weeds often blow into the ditches, forming shoals where weeds can start, and sand or silt, either from dust storms or caving banks, accumulate in the ditches if the velocity be low, whereas a swifter current would carry out both weeds and silt.

The small quantity of water usually carried by a drain and its rough perimeter make it seldom possible to give it grade enough to permit destructive erosion, and for these reasons it should generally be given all the grade available.

For the same reasons it is desirable to avoid abrupt turns in the alignment of the ditch, and to avoid inverted siphons, and to give necessary culverts liberal openings, and in all respects to avoid sacrificing grade, or introducing structures which may promote obstruction by sand or floating débris.

To obtain the requisite grade for the ditches it is generally necessary to build them in the direction of the greatest slope of the country.

5. Depth.—The ground water on irrigated land should be kept 5 feet or more below the surface of the ground. To accomplish this the bottoms of drainage ditches must be considerably lower, in order to make allowance for three principal factors:

1. The depth of water in the ditch when in service, which deducts that much from its drawing depth.
2. The gradient which the water table must assume to discharge its surplus water.
3. The inevitable decrease in depth of the ditch due to sloughing and accumulation of detritus.

It often occurs that in excavating a drain sand is encountered below the water table, which under the influence of inflowing water oozes into the ditch, and it becomes impossible to excavate to the required depth without holding the banks by artificial means. This is the only remedy where tile drains are being placed, and greatly retards the work and increases the expense.

Where such material is encountered in constructing an open drain, the best plan is to make the ditch as deep as practicable, and to go over it again a few weeks or months later. In the meantime the water table will have been lowered by the drain, and it becomes possible to make the drain considerably deeper, and perhaps deep enough, although sometimes a third effort may be necessary.

6. Capacity.—One of the most difficult problems to be solved in designing a drain is to determine the necessary capac-

ity which depends of course on the amount of water to be removed. No general rule can be given as a safe guide to the solution of this question. Some waterlogged lands yield very little water to drainage works. In other cases, where the soil is open where seepage from canals is large, and water is lavishly applied in irrigation, leading to heavy accretions to ground water, the land may discharge into the drains more than half of the water brought to it by canals. These conditions, moreover, may not be permanent. Canals which at first lose heavily by seepage may and often do improve with age by silting their channels, or they may be lined in the worst places to save water. Irrigators who apply water lavishly at first may learn the folly of this practice and use water more sparingly.

All these conditions and possibilities must be taken into account in estimating the capacity of the drains. In the case of the open drain, which is sure to deteriorate, it is safe to make its capacity liberal and let it suffer deterioration to the necessary capacity, thus saving in maintenance costs. If provision is made in advance for future enlargement this is easily accomplished with open drains, so that foreknowledge is not absolutely essential.

Not so with closed drains. If the tile is not large enough to discharge the necessary water, it cannot be enlarged without entirely rebuilding the drain. If it is too large considerable extra expense is wasted, but as this is much less serious than if too small, it is best to make the capacity liberal.

The bottom width of an open drain should be fixed according to the required capacity with due allowance to rough construction by machinery so that its coefficient of friction is large. A factor of roughness in the Kutter formula, $n = .03$, is about an average for new ditches, but to preserve such a factor the maintenance must be fairly well cared for.

7. Form of Tile.—The best form of tile used for drainage purposes is the vitrified clay tile, cylindrical, without the bell mouth employed for sewers. These tiles are laid end to end as close as possible, and a strip of tar paper 3 inches wide, with a length one-half the circumference of the pipe, is laid over each

joint to prevent the entrance of sand which might clog the tile. The water can then enter the joints below the horizontal diameter.

A board of a width nearly or quite as great as the diameter of the tile should be laid in the bottom of the trench to keep the tiles from settling out of line. As the tiles are laid, it is well to pack some earth against them to hold them in line horizontally until the trench is backfilled.

If the drain is laid in quicksand it is best to use a better foundation than the board above described. This may consist of two pieces of 2 inch by 4 inch lumber spaced parallel with a space between about half the diameter of the tile, and nailed together by three or four cross-pieces, forming a ladder. This is laid in the trench with the cross-pieces underneath, and the tiles are fitted into the space between the sides of the ladder which holds them in place both horizontally and vertically.

When convenient it is best to allow the tiles to remain in place a few days before backfilling, and to inspect them to see that they have not become displaced.

The backfilling should be performed carefully so as not to displace the tiles, and where a choice is possible, it is well to place the coarsest material available next to the tiles. Any tile drain is improved by placing gravel next to the tile before backfilling.

8. Manholes.—At intervals of about 100 feet it is advisable to provide an open well to serve as a manhole. This can be lined with lumber, and the drain from above can discharge into the well, and the lower drain carry the water away. These wells have several uses. They may serve as sand traps, to catch any sand that may be traveling down the drain which might clog it. For this purpose, the bottom of the well should be 2 or 3 feet below the grade of the drain, and should be kept cleaned out. The well should be at least 3 feet in diameter so as to permit a man to work in it. Such wells serve to show whether the drain is operating under a hydrostatic head, in which case the water will stand in the well higher than the top of the tile. Such a well should be placed at any point where

the grade of a drain changes in such a way as to check the velocity of the drainage water, for at and below such critical points there is a tendency to deposit sand, and it is desirable to remove this by means of the well.

In case of a broken tile or other derangement of the drain, frequent manholes assist in locating the trouble. Where the slope of the ground changes, making it necessary to reduce the slope on which the drain is laid, the size of the tile should be increased so as to give it at least a greater capacity than the portion of the drain above. Such a change is most conveniently made at a manhole. The manhole or well is a convenient location for a weir to measure the discharge of the drain, a record of which should be carefully kept, as it is of great value in denoting the action of the drain, and its effect on the ground water.

9. Wooden Drains.—Where earthen drain pipe is very expensive on account of freight charges, and lumber can be cheaply obtained locally, wood has been used instead of clay tile. The economy of this is generally doubtful, unless it is certain that the wood will be continuously saturated. Otherwise, its early decay will require its replacement so soon as nearly or quite to neutralize its advantage in low first cost. Where wood is used, it may be formed into a square box, of such length as convenient, and if the box is large, the top should be laid with the grain transverse to the length of the drain, to give it the required strength. Each board forming the top should be slightly gained at each end, so that it will fit to the sides, and prevent their collapse from lateral pressure. A similar precaution may be taken with the bottom, so that little dependence need be placed upon nails to hold the parts of the box in place. The bottom should break joints with the sides, to preserve the alignment.

10. Cement Drains.—In some cases cement pipe may be cheaper than clay tile, and it answers the purpose well unless alkali is present. If the soil contains much alkali, especially sulphates, there is danger of the cement pipe disintegrating especially if not running full continuously.

The U. S. Bureau of Standards in cooperation with the Reclamation Service has made a series of tests on the use of cement pipe as drain tile, exposed to soils containing alkaline salts, and draws these conclusions:

1. The use of cement tile in soils containing alkali salts in large quantities is experimental.
2. Porous tile due to the use of lean mixtures or relatively dry consistencies are subject to disintegration.
3. Some dense tile are under certain conditions subject to surface disintegration.
4. Disintegration is manifested by physical disruption caused by the expansion resulting from the crystallization of salts in the pores and by softening, resulting from chemical action of the solutions with the constituents of the cement.
5. While results obtained will not permit of a definite statement as to the relative effect of the various constituents of the salts, indications are that the greater the quantity of sulphate and magnesium present and the greater the total concentration of salts the greater will be the disintegrating effect.
6. Tile made by the process commonly used, which allows the removal of forms immediately after casting, are subject to disintegration where exposed to soils or waters containing $\frac{1}{10}$ per cent or more alkali salts similar in composition to those encountered in this investigation.
7. The hand-tamped tile of plastic consistency as made in this investigation are not equal in quality to machine-made tile of the same mixture, and they do not resist alkali action as well.
8. Steam-cured tile show no greater resistance to alkali action than tile which are cured by systematic sprinkling with water.
9. Tile made of sand cement have less resistance to alkali action than the tile made of Portland cement of the same proportions.
10. The tar coating as used is not effective in preventing the absorption of alkali salts from the soil.
12. No advantage is found in introducing ferrous sulphate into the cement mixture.

If cement drain tile are to be used in alkali soils or waters containing 0.1 per cent or more of salts they should be made of good quality aggregate in proportions of not less than one part Portland cement to three parts aggregate. The consistency should preferably be quaking, which has proved the most resistant of all mixtures used.

11. Drainage Works of the U. S. Reclamation Service.

TABLE XXVIII.—OPEN DRAINS

Project	Length, Miles	Excavation, Cu. Yds.	Drained Acres	Cost		
				Per Mile	Per Cu. Yd.	Per Acre
Boise	130.0	5,533,002	64,680	\$5281	\$.067	\$10.58
Minidoka	108.0	3,367,518	72,000	6143	.111	9.22
Yuma	16.8	375,000	8,000	7650	.250	14.00
North Platte	23.5	410,640	2,900	4000	.140	30.00
Carlsbad	11.7	292,248	4,320	6336	.255	17.25
Rio Grande	22.8	865,300	6,000	8815	.115	16.00
Umatilla	10.0	225,000	2,000	5481	.244	27.40
Klamath	77.5	972,000	17,400	3718	.200	16.50
Shoshone	13.5	486,500	2,000	7200	.174	26.50
Huntley	13.2	504,150	19,400	7630	.150	16.25

TABLE XXIX.—CLOSED DRAINS

Project	8 INCHES		10 INCHES		12 INCHES	
	Length, Feet	Unit Cost	Length, Feet	Unit Cost	Length, Feet	Unit Cost
Yuma						
Huntley	11,470	\$0.97	22,089	\$1.37	99,217	\$1.44
North Platte			3,550	1.39	39,838	1.39
Carlsbad			15,250	1.46	4,445	1.62
Klamath			17,107	0.98	25,661	1.04
Shoshone			89,334	1.14	151,428	1.20
Total	11,470	\$0.97	147,330	\$1.27	320,589	\$1.34

TABLE XXIX.—CLOSED DRAINS—*Continued*

Project	15 INCHES		18 AND 20 INCHES		Total Cost.
	Length, Feet	Unit Cost	Length, Feet	Unit Cost	
Yuma.....	5,525	\$1.50	15,400	\$1.71	\$34,597
Huntley.....	101,935	1.46	13,635	1.37	358,893
North Platte.....	31,102	1.39	126,104
Carlsbad.....	44,013
Klamath.....	43,452
Shoshone.....	90,275	1.31	60,586	1.44	460,940
Total.....	228,837	\$1.45	89,621	\$1.50	

Remark: Average cost of closed drains in table \$1.35 per foot.

REFERENCES FOR CHAPTER XII

- KING, F. H. Irrigation and Drainage. The Macmillan Company, New York.
- DAVIS, ARTHUR P. Irrigation Works Constructed by the United States. John Wiley & Sons, New York.
- HART, R. A. Drainage of Irrigated Land. Bulletin No. 190, Office of Experiment Stations.
- TANNATT AND KNEALE. Seepage and Drainage. Bulletin No. 76, Montana Agricultural College, Bozeman, Montana.
- Engineering Record. Cost of Excavating Drainage Ditches with Steam and Electric Machines. Vol. LXX, No. 26.
- YARNELL, D. L. Trenching Machinery used for Construction of Trenches for Tile Drains.
- ELLIOTT, C. G. Drainage of Farm Lands. Farmers' Bulletin No. 187, U. S. Office of Experiment Stations.
- CRONHOLM, F. N. Drainage System for North Side Minidoka Irrigation Project. Engineering Record, April 15, 1914.
- MURPHY, D. W. Drainage of Shoshone Irrigation Project. Engineering Record, June 6, 1914.
- BURKHOLDER, J. L. Conserve your Little Drop of Water and Help Keep Down the Peak. Reclamation Record, December, 1917.

CHAPTER XIII

CANALS AND LATERALS

1. **Capacity.**—To decide upon the necessary capacity of an irrigation canal, it is necessary to know approximately the three main factors which control:

1. The acreage of land to be served.
2. The duty of water.
3. Seepage losses to be expected.

Unless great care is exercised in considering each of these factors and conservative estimates are made, much danger exists of serious error in the determination of each one. The principles upon which decisions must be based are given in the preceding pages.

The data for such decisions are not accurately determinable in advance, and careful consideration must be given to the margin of safety to be allowed to guard against unavoidable errors both in the data and the conclusions drawn from them.

Having determined the three factors above listed, the capacity of the canal may be conveniently found by the following formula:

Let c = capacity required in cubic feet per second;

a = area to be irrigated in acres;

d = average depth of water in feet required on the land in the 15 days period of maximum use;

p = percentage of loss by seepage and evaporation.

Remembering that a stream flowing at the rate of 1 cubic foot per second carries 29.7 acre-feet of water in 15 days, we have

$$c = \frac{ad}{29.7} \left(1 - \frac{p}{100} \right). \quad \dots \dots \dots (1)$$

Example: Required the capacity at head of main canal, necessary to serve 10,000 acres of land, where the maximum requirement

of crops for a 15-day period is an average depth over the irrigable area of .3 foot, and the losses in canals when operating at full capacity will be 20 per cent of the water diverted, or

$$a = 10,000,$$

$$d = .3,$$

$$p = 20.$$

Then by (1)

$$\frac{.3 \times 10,000}{29.7 \times 80} = \frac{3,000}{23.76} = 126.26.$$

In the design of the canal some excess capacity should be provided to allow for possible errors in the assumptions which must be made from uncertain data. Excess capacity is not wasted, for a canal begins to deteriorate as soon as built. Wind, rain, frost and the trampling of animals work the banks down and tend to fill the canal with dirt and trash, and the capacity thus gradually diminishes unless restored by annual repairs. This is especially true where the water contains much silt. In such cases it is always best to provide considerable excess capacity so that a substantial lining of silt may be allowed to remain in the canal, as this not only saves the cost of removing the same, but improves the canal by rendering it less pervious and decreasing its coefficient of friction. Unless such excess is allowed, especially in laterals, the silting may so decrease the capacity as to make it impossible to deliver sufficient water for the needs of the crops while it may be impossible to close the canal for cleaning without heavy loss to the farmers requiring the water. The requirement for a large excess capacity is most advisable on the small laterals, where the tendency to deposit silt is often great, and where the cost of constructing such excess is generally small. It may sometimes even be advisable where water is very silty to build the laterals of two or three times the capacity absolutely necessary for service, and allow them to accumulate silt until the capacity diminishes to that required, as this is both better and cheaper than frequent removal of small quantities of silt. Larger quantities can be removed at a lower unit cost.

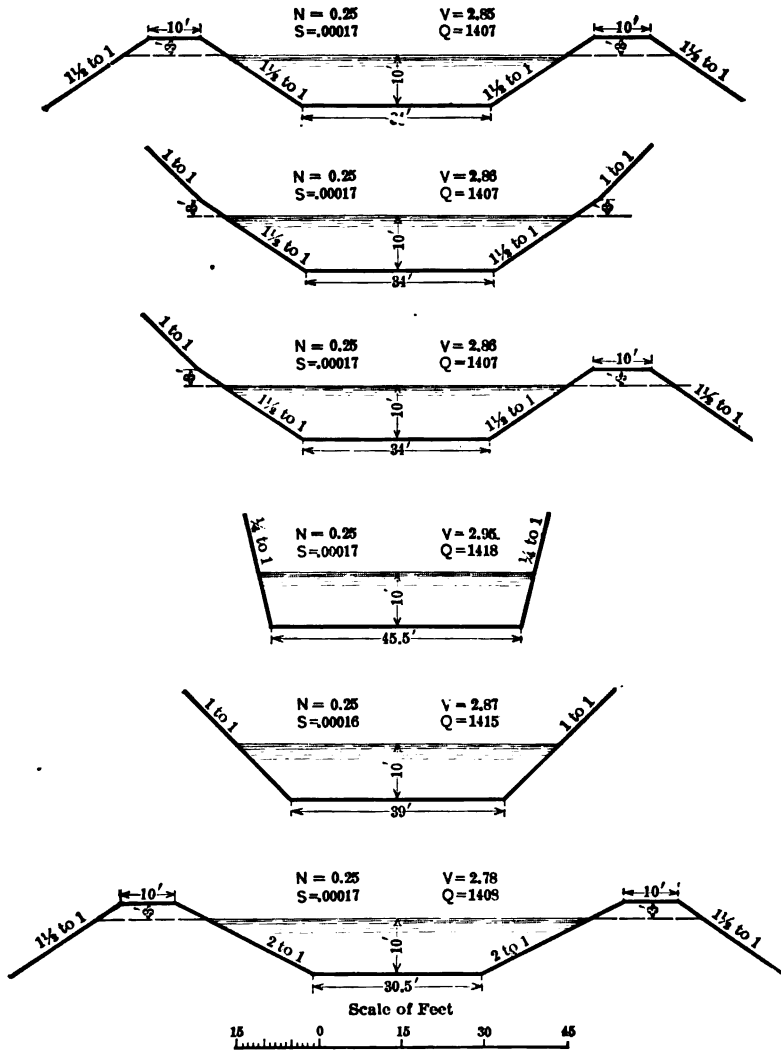

FIG. 63.—Cross-sections of Interstate Canal, North Platte Valley, Nebraska.

2. Design.—The problems of canal design and location may be divided into two general cases:

1. Cases in which the water supply is greater than the available land, making it necessary to give the canal the least practicable grade, in order to command by gravity canal the maximum area of land, or to reach a sufficient area without undue length of canal.

2. Cases in which the area of good land readily commanded by the canal is in excess of the available water supply, or the configuration of the country is such that abundant fall is available.

Where it is very desirable to save grade, as in case 1, the canal should be given a section such that it will have a large hydraulic radius, and hence have a reasonably high velocity on the gentle grade given. In a rectangular channel, the hydraulic radius, and consequently the velocity, is a maximum when the depth of water is one-half the width. A rough rule for trapezoidal channels is that the depth should be about half the bottom width, to give maximum capacity, but this rule is generally modified by considerations of economy of construction and operation, which require less depth and greater width, except on side hills; especially is this true of large canals. The advisable section lies somewhere between the cheapest section and the one affording the highest velocity. It must be determined in each individual case by a consideration of all details affecting the problem, such as the value of the land to be gained, and whether the water carries silt, making a good velocity necessary to prevent silting of canals.

In the second case cited where ample grade is available, it is generally desirable to give the canal as much velocity as the earth will stand without erosion, and where rock, gravel, or hardpan must be excavated economy may often be promoted by increasing the grade and velocity of the canal so as to reduce the cross-section and thus save excavation. It should be remembered, however, that in such places there is often danger of seepage through the seams of the rock or gravel, and where velocities are high it becomes impossible to close such crevices

by the process of silting, and it may be necessary to line the section with concrete, in which case a further increase of velocity due to the greater smoothness is secured, and the cross-section may then be further reduced. In fact where it is necessary

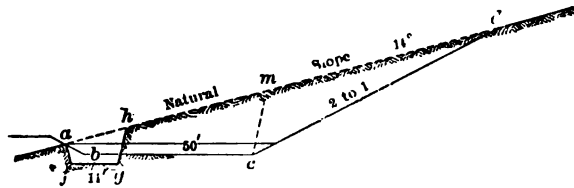

FIG. 64.—Canal Cross-sections for Varying Bed-widths.

to cut through rock for any great distance the cost may often be reduced by lining the cut with concrete, which so reduces the friction that the higher velocity permits a reduction in cross-section sufficient to save the cost of lining. This is especially the case with deep cuts or side hill location.

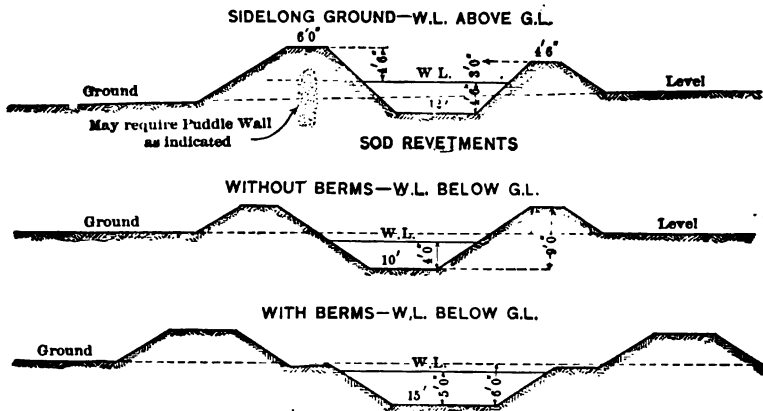

FIG. 65.—Various Canal Cross-sections.

In the construction of earthen canals, economy requires that embankments be utilized to assist in forming the waterway, and the most economical form is that in which the excavation is sufficient to form the embankment with a small allowance for wastage and shrinkage, usually assumed about 10 per cent for small canals, and 5 per cent for large ones. On level or gently

sloping ground, a wide and shallow canal in which excavation equals embankment is, for a given cross-section cheaper than a narrower and deeper one. It has a greater perimeter and less hydraulic radius, and hence requires more grade for a given velocity, but if this is available a wide canal may be advisable. This, however, introduces another element that must be studied.

In general the seepage from a canal is roughly proportional to the wetted area, and therefore in uniform material more seepage may be expected from a wide than from a narrow canal. If the material is naturally porous, this result may be emphasized,

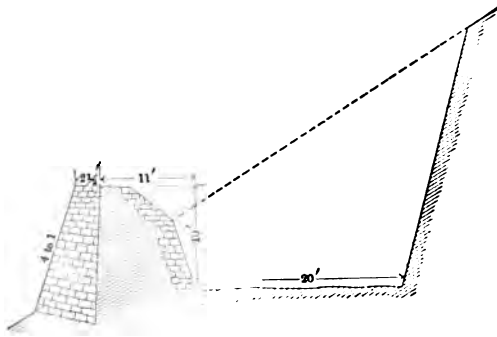

FIG. 66.—Rock Cross-section, Turlock Canal.

for in such cases, an artificial bank can often be made tighter than the natural material, and the narrow canal with its greater proportion of embankment may be tighter than the wide one. Local conditions, however, may greatly modify this result. It often happens that the upper soil which contains loam is better adapted for making a tight waterway than that which underlies it, and the narrow canal with its deeper cut may expose a coarse gravelly subsoil, into which seepage may be so rapid as to overbalance the decreased surface of percolation. For these reasons it may be advisable to adopt varying types of cross-section on different parts of the same canal in accordance with the soil and subsoil conditions.

On nearly level ground a given canal cross-section requires less excavation if wide and shallow than if narrow and deep.

A given amount of material is required for the formation of banks of a certain height, and the wider apart these are placed the greater the cross-section of the waterway. Where the location is on a side-hill slope, this rule does not obtain, as the difference in elevation between the two sides of the canal requires a high bank on one side and none on the other. Further widening requires a still higher bank on the lower side, and a heavier cut on the upper side, so that on hillsides, the narrow, deep section is generally cheaper, and this is the more emphatic as the hillside becomes steeper. Where the side hillside slope is very steep, the slope of the canal section will intercept the surface

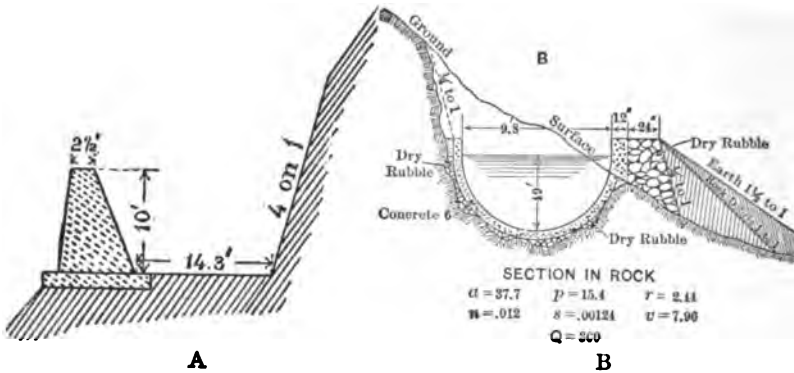

FIG. 67.—Rock Cross-section; Umatilla Canal.

slope of the ground at some distance above the canal, and to prevent excessive cost it becomes necessary to make the canal slopes as steep as possible and in extreme cases to make them of the character of a masonry retaining wall. At the same time it may be advisable to make the lower bank of earth on the usual slopes, giving rise to cases where the two sides of the waterway have different slopes. The economic section will depend also, to some extent, on the character of the material to be excavated. In hard rock the cost of excavation makes yardage predominant, and a lined channel is generally economical. In open or porous material, the area exposed to seepage is important, and may require the minimum attainable wetted perimeter.

Where the water to be carried is clear, and growth of aquatic plants is to be anticipated, the deeper canal has advantages, because less likely to permit the growth of such plants. They require bright sunlight, and deep waters shade the bottom of the canal too much for their fullest development.

Large canals on nearly level ground are sometimes constructed with a berm, or level width of natural ground between the excavated channel and the banks. This has the advantage of affording a shallow section and therefore low velocity next to the banks and less tendency to erode them, but this also encourages the growth of weeds and aquatic plants, and the provision of berms is not usually advisable practice.

The side slopes of canals in earth should be made somewhat flatter than the natural slope of repose of the material, in order to add to their stability and diminish their tendency to slough and to work down the slope. Slopes of two horizontal to one vertical are common, and are good practice in average ground. Banks of sandy soils are sometimes made flatter, and very firm soils may be left steeper, especially in cut, which may sometimes retain stability on steeper slopes than the same material requires in embankment. In deep cuts economy demands that the banks be left as steep as safety will permit. In loose sand and gravel this is about $1\frac{1}{2}$ horizontal to 1 vertical, being very little flatter than the angle of repose. Firm clay may stand much steeper than this, as may also indurated material of all kinds. Fairly firm rock will stand practically vertical, except in very deep cuts, and between this limit and the slope given for sand, all other materials find their safe slopes.

The top width of canal banks should vary with the size of the canal. Where large canals follow nearly on contours, with higher ground on one side, and lower ground on the other, the upper bank may be rather light, as its rupture will not threaten serious damage, while the lower bank must be made much heavier to give necessary security against disastrous breaks. It is generally advisable to make the lower bank of a large canal wide enough to form a wagon road. This facilitates the patrol of the canal, saves other land necessary for such a road, and

adds stability and security to the canal. Such a road should not be less than 10 feet in width, and a greater width is better, especially in light sandy soil. Turnouts for passing teams should be provided, which can be done without extra expense at points where excess cut furnishes considerable surplus material. The lower or main bank should be at least 3 feet above the water level of the canal in large canals, but may be less in small canals.

The lower bank of the canal must be carefully built, and if the excavated material available for canal building is coarse, care must be taken to place such fine material as it contains on the water slope, and the coarser material on the outside. If not enough fine material is found in the canal prism for this purpose, it may be necessary to haul clay or loam from a distance for this purpose, or in some cases it may be advisable to line with concrete. A bank of coarse gravel or broken rock on a good foundation is an ideal bank, provided the water slope is made practically impervious with clay or otherwise.

Cross-section with Subgrade.—In light soils it has been found advantageous to dig a subgrade 1 to 2 feet below the original canal bed. The cross-section gradually approaches that of the ellipse and tends to keep the current in the center of the channel and to keep up its flow with the least exposure to friction and seepage when the volume of water in the canal is low. The subgrade (Fig. 68) is given by practically designing the canal as if it were to have a trapezoidal cross-section with berm, and then evening off the slope by removing the berm and continuing the slope from the bottom of the canal toward the center.

It is sometimes necessary to locate a conduit, along a steep hillside, where the material naturally lies about the angle of repose, so that the excavation of a canal would so weaken its support as to cause such a tendency to slide that the canal would be unsafe. Several alternatives are then presented.

1. To excavate a bench and build a flume upon it. It may be that this will too greatly weaken the hillside, and invite sliding, especially in the presence of the water of the canal.

2. Without disturbing the natural material, build a flume

on a trestle, elevated sufficiently to permit rolling rocks to pass under. If this flume is to be of concrete, it would be expensive. If of wood or steel, it would be rather short lived.

3. A pipe may be built and buried, leaving the slope in its original condition. This would be the safest, but most expensive of the solutions, and might be prohibitive.



FIG. 68.—Cross-section of Calloway Canal in Sand, showing Subgrade.

4. A compromise among the above alternatives sometimes adopted is to excavate a bench and build thereon a concrete flume with sufficient strength to support the upper bank like a retaining wall, and thus restore the support to the slope, without involving as heavy expense as the pipe in solution 3.

The lined canal or flume in the Tieton Canyon of Washington may be classed as a case of this kind. Fig. 70. This flume

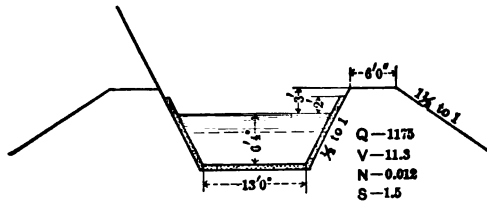

FIG. 69.—Typical Section of Lined Canal.

is of circular section, with a segment cut off the upper part, and concrete chords provided to restore its rigidity. The circular section and the chords were both reinforced. They were manufactured in 2-foot sections in the bottom of the canyon, where ample room and materials were available, and were hoisted to place and joined in a continuous flume in place by cement joints.

Where stretches of lined canal are on a very steep grade the water assumes a correspondingly high velocity, and measures to destroy this velocity may be necessary at the foot of the steep grade, and it may also be necessary to provide a regulator

at the upper end, to shut out the water at times. Such a combination is called an inclined drop, or chute. It is, of course, located at the point where the necessary fall can be compressed into the shortest practicable distance. It consists essentially of an inlet structure, a trough to conduct the water down the hill, and a pool at the bottom to receive the water and destroy its accumulated energy. The inlet structure forming the transition is provided with splayed wing walls, and well equipped with cut-off walls for the wing walls, floor and sides, to prevent percolation of water along the structure. At the lower end, where the water enters the trough, it is provided with control gates. The trough converges to a narrow channel a short distance below the gates, to correspond to the increased velocity, which may reach about 40 or 50 feet per second, the section again increasing as it approaches the pool at the bottom. Cut-off walls are provided under the trough at frequent intervals to prevent erosion by leakage or rain water. These are generally 1 foot deep, except at expansion joints, where they are deeper.

3. **Alinement.**—Owing to its moderate velocity, the alinement requirements of canal location are not so rigid as in railroad work. Location upon the contour that will keep the cut and fill in approximate balance is generally the cheapest per foot, but on rolling ground this may make the line so crooked as to introduce excessive curvature and to increase the length to such an extent as to actually increase the yardage excavated, over a less tortuous location. On curves there is always a tendency to erode the bank on the convex side of the canal and unless the velocity is very low this must be carefully provided for. Where the convex side is an embankment, as when passing around the end of a ridge, it is generally best to throw the location into cut in order to resist the tendency to erode, and this will also eliminate part of the curvature. This will shorten the line, improve the alinement and make a safer location, and accordingly some increase of cost can be justified. A great variety of rules have been suggested concerning curvature limits, but these are of little value, as the limits must be determined by circumstances above discussed. A straight alinement is best, but curvatures

can be introduced to almost any extent demanded by economy, and not prohibited by safety.

Various rules have been proposed, limiting the curvature to certain relations to the width or depth of the canal, but these

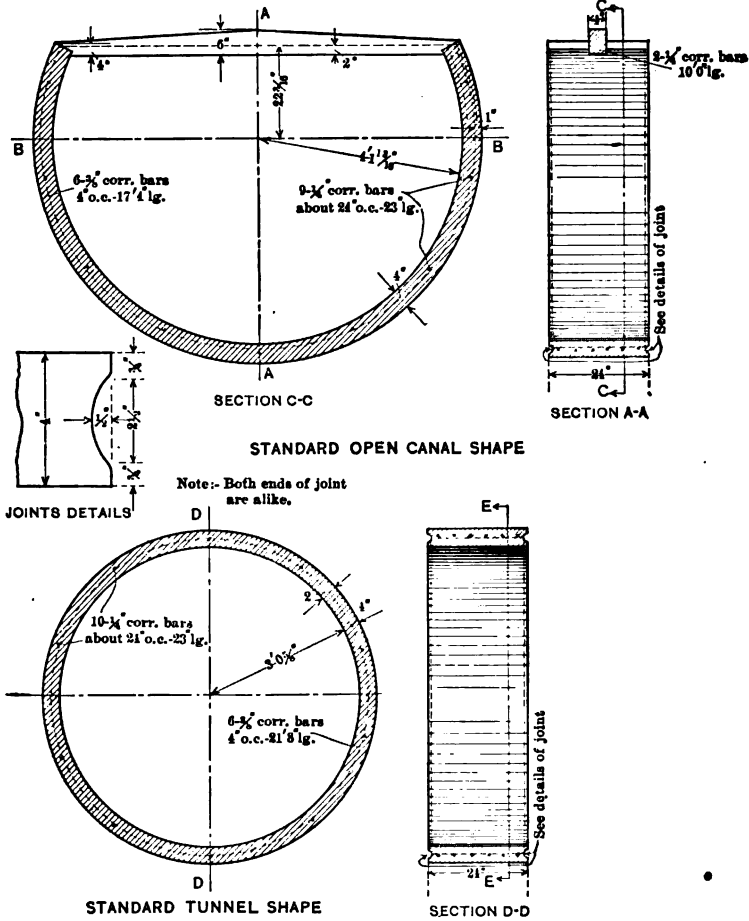

FIG. 70.—Tunnel and Canal Sections, Tieton Main Canal.

appear illogical as the erosion will depend not so much upon the width nor the depth, as upon the velocity of the water, next to the bank. It is true that the larger the volume of the flowing water, the greater the difference between the maximum and min-

imum velocities, and on curves the maximum tends to approach the bank on the outside of the curve, and in this way to increase the liability to erosion. This tendency increases as the curvature increases, and also as the velocity increases. Any rule for curvature must, therefore, recognize all these influences, the greatest of which is the velocity. Different materials resist erosion in differing degrees, and any rule fitting average earth must be modified for lighter or heavier soils.

For average loam soils, the following is a safe formula:

$$R = V^2\sqrt{A} + 40.$$

In the above equation

R = Smallest permissible radius of curvature of the center line of canal on exterior curves, expressed in feet;

V = The mean velocity of the stream, in feet per second;

A = The cross-sectional area of the stream in square feet.

The constant, 40, insures a radius exceeding 40 feet under all circumstances, however small or sluggish the canal.

A canal having a mean velocity of 2 feet per second may have a curvature radius one-half that of one with a mean velocity of 2.83, since the squares of these velocities are 4 and 8 respectively.

Shorter radii may be used on interior curves, and in firmer material, but the radius should be made longer in very light soils easily eroded, and where a break in the canal would be especially disastrous, as on steep side hills.

The tendency to erode the bank on the outer side can be counteracted to some extent by a superelevation of the bottom of the canal, or in other words, deepening the canal on the inner side of the curve and making it shallow on the outer side. This tends to keep the thread of maximum velocity from the outer bank. If very sharp curvature is necessary, the outer bank can be protected by a blanket of gravel, or in extreme cases by rip-rap of brush or rock. Very sharp curvature increases the friction on the banks, and may require a slight increase of grade to compensate, but the amount of this is not accurately known, and for moderate or low velocities is practically negligible.

For high velocities some compensation for sharp curvature must be made, varying with the roughness of the channel.

Where the rolling character of the country requires heavy cuts through ridges to prevent an excess of curvature, the same reason suggests fills across low places to utilize the excavated material, and further straighten the alinement. But while cutting the ridges increases the safety of the canal and reduces maintenance charges, the construction of high fills has the opposite effect, and may be a serious matter in countries where the banks are attacked by burrowing animals. In such cases, therefore, there may be an excess of excavated material which cannot be utilized, both for the above reason and the long hauls that its utilization may involve.

Where the above circumstances afford a latitude of choice, it is generally advisable to make two or more preliminary locations and compare their estimates of cost, considering at the same time the relative safety and alinement of the several locations. Where one location is undoubtedly safer than another, considerable expense may be justified to secure such safety, especially on large canals, not only on account of the cost of maintenance, but also the security of the water supply where a break in a large canal may do great damage directly, and indirectly involve loss of crops.

4. Velocity.—The velocity given a canal must not be so great as to involve destructive erosion to the channel, as this will increase the difficulty of diverting the water into laterals for use, endanger the foundations of bridges and other structures, and sometimes by progressive cutting of banks destroy fertile lands. The eroded material will be largely deposited at points where the velocity slackens, and the regimen of the canal will be thus deteriorated.

It is, however, desirable for many reasons to give the canal as high a velocity as possible without destructive erosion, if the necessary grade is available. Such a velocity will tend to prevent the growth of aquatic plants, and the deposit of silt and trash in the canal, and the necessary water can be carried in a smaller canal if the velocity is high than if it is low.

The maximum permissible velocity depends on the resistance to erosion of the banks of the canal, which varies widely with different materials. Where these are composed largely of clay, they may have a considerable adhesion and consequent resistance to erosion, and any loosened particles in suspension are easily transported by a velocity that will not attack the mass of clay in the bank. With fine sand or silt the margin is not so great, and it becomes a problem of some difficulty to select and attain the velocity which will transport all the silt in suspension without cutting the banks. When such a velocity is found for the canal running at full capacity, trouble may be encountered when the canal is operated at part capacity, when of course the velocity is diminished, and the tendencies characteristic of low velocities are all increased. For this reason it is important to secure the highest velocity that will not erode the banks, and even to provide considerable protection at curves to prevent destruction of banks by erosion. The reduced velocity at part capacity causes canals carrying silt-laden water to deposit silt when running part full, and as this may be of frequent occurrence such canals are often badly silted and require much cleaning. For this reason a canal which is to carry muddy water should generally be constructed with considerable excess capacity, so that a moderate amount of silting may be endured without embarrassment, and the cleaning postponed till the winter season. It is well, also, to permit some silt to remain permanently in the canal because of its tendency to close the crevices and pores of the soil and reduce seepage losses from the canals and laterals. A thin lining of silt also increases the discharge of a canal by forming a surface smoother than the original, and decreasing the friction of the water upon its conduit.

Very few soils, unless indurated or gravelly, will resist a higher mean velocity than 3 feet per second, and it is ordinarily necessary to keep the velocity considerably below this. Most soils will safely stand a mean velocity of 2 feet per second, and a general rule is that velocities in earth should be somewhere between these extremes, varying with the character of the soil and the requirements for grade, and also with the depth of the canal.

The erosive power of a current depends not upon the mean velocity of the stream, but upon the velocity of the film of water around the perimeter of the prism. This is greater in proportion to the mean velocity in shallow than in deep canals. It follows that deep canals will stand a higher mean velocity than shallow canals in the same material.

5. **Lateral Systems.**—Every large canal system ramifies throughout the land to be irrigated somewhat like the branches of a tree. Beginning with the main canal, this follows the upper edge of the land to be irrigated, except in cases where the water is to be pumped to still higher tracts. It may proceed some distance before it reaches any irrigable land. When it does, the land may be in a narrow strip which can be irrigated from a single tap box or two in the side of the main canal, but eventually a wide tract is reached which requires the diversion of a large lateral, to carry a considerable body of water to a large area reaching some distance from the main canal. Such a lateral must also be located on high ground with reference to the land which it will serve, and must send off branches located also on relatively high ground.

On typical rolling ground where the normal system of natural drainage depressions occur, the lateral system follows a rule generally the reverse of the general drainage system. That is, the main canal cutting across the country drainage sends out a main lateral down each main ridge, and this lateral sends out smaller laterals down the subordinate ridges, from which sub-laterals diverge on each side. Thus, every ridge is crowned by a lateral and bounded on each side by a ravine, or depression.

The rules for locating a lateral system on such land are relatively simple as above indicated, but the system itself may be complicated and difficult to design, construct, maintain and operate. The topography may require a large number of sub-laterals to follow each ridge, with a corresponding number of turnouts and tap boxes. Each farm must have at least one tap-box to deliver water at the highest point of irrigable land, from which it can be led by gravity to lower ground. If the individual farm is cut by a ravine a second turnout may be needed, on the

opposite side of the depression, and conditions may be such that several of these may be required on a farm of moderate size. The slopes also may be so great as to induce destructive velocities unless drops are introduced, and in some systems hundreds of these are required. Such a system will also have numerous drainage crossings of various forms. All these add to the complication and expense in design, construction, maintenance and operation, and demand immense and intense preliminary study of the numerous alternatives which will present themselves. These can be made most efficiently and economically

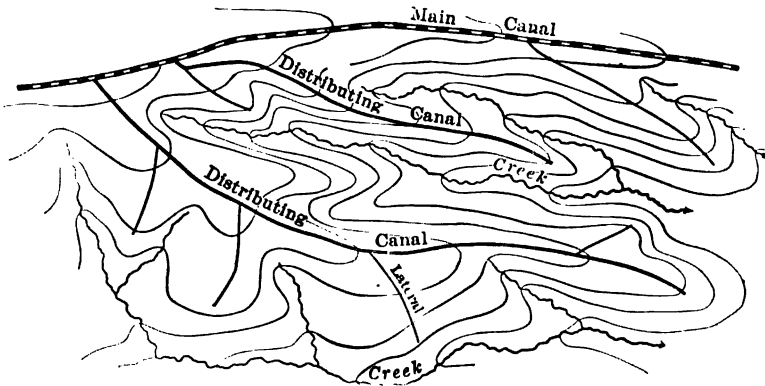

FIG. 71.—Diagram Illustrating Distributary System.

on an accurate topographic map of the entire irrigable area of suitable scale and contour interval.

From this conventional topographic condition, with a definitely marked system of natural drainage, we have all shades of variation to the smooth alluvial valley with two main slopes, one down the valley, and one normal to this, toward the stream. With such smooth topography, on moderate slopes, the distribution system is greatly simplified and cheapened as compared with that on more rolling country. In rare cases the slope may be insufficient to furnish the necessary fall for economical gravity irrigation. An illustration of such a case is the Minidoka Project of the U. S. Reclamation Service, where in order to obtain and keep the requisite slopes for the gravity canals, it was necessary to build a diversion dam 46 feet high, and to build most of

the canals and laterals between high banks constructed from borrow pits, so that the water surface is held high above the adjacent country, thus giving slope to make the water run over the surface of the fields. Such instances, however, are rare, as most irrigable tracts have ample slopes, and excess slope is far more common than deficiency. The smoothest valley, appearing to the eye to be absolutely level, generally has slope enough for gravity irrigation, and may even have an excess.

Perhaps the most difficult type of land surface to supply with a distribution system is that of eolian origin, where the surface, originally a series of sand dunes and depressions, may be modified by time but still maintains the character, and is underlain with a subsoil coarse enough to absorb the meager rainfall promptly, and no surface drainage system is formed. Such a topography, with its low hills and hollows without law or system, presents peculiar difficulties to the topographer, and especially to the engineer designing a distribution system. Many of the shallow depressions are bowls or sinks without surface outlet, and many of the low mounds are isolated and can be reached by the laterals, if at all, only by means of high fills, or by pressure pipes to carry the water across low ground. The studies necessary for planning a system for such lands require a good topographic map with less vertical interval between contours than most other classes of topography require, and such a map, though expensive, is imperatively necessary.

The shallow depressions in this class of land, having no outlet, may become swamps or ponds from the accumulations of surface drainage or the rise of ground water, or both, and the lowest parts of such bowls should generally be excluded from the area classed as irrigable.

Many of the isolated elevations will be too expensive to reach, or the long fills necessary may be too burdensome in maintenance, and it is then best to eliminate them, or to postpone their development until land values have increased enough to justify their reclamation. It should never be forgotten that canals running on high fills present especial hazard and expense in maintenance. Not only may they be subject to slides, especially if

of clayey material, but they are the favorite haunts of burrowing animals, and incipient breaks have such head of water that they rapidly enlarge, and become disastrous.

6. Design of Laterals.—In cross-section, laterals should usually have a greater depth in proportion to width than larger canals. This reduces the area exposed to seepage and evaporation and economizes in drops, bridges and other structures. It gives better hydraulic conditions for economizing grade, which may be important in level country. It also gives less encouragement to the growth of weeds on the margin and of aquatic plants on the bed of the lateral. In any canal through arable soil, vegetation is sure to grow along the margin of the water, and this gradually encroaches on the waterway, affording a lodgment for sand and silt that may roll down the bank or be carried there by the water or the wind. Thus, gradually a turf is formed, building farther out into the canal, protected by the roots of the grass and weeds growing upon it and forming a new bank steeper than the original below the water surface with a berm just above. Where ample capacity has been provided, this may be a desirable development, as it furnishes a berm to catch the material that may ravel from the bank, and has no injurious effects on the waterway if not carried too far, and if care is taken to prevent the development of noxious weeds thereon. This tendency to steeper banks shows the fallacy of giving lateral sides especially flat slopes for the sake of stability. Such slopes are often made as steep as 45 degrees or steeper, and it may be difficult to maintain them much flatter, even if this were desirable.

For the sake of stability previous to the development above described, it is necessary to provide side slopes not steeper than $1\frac{1}{2}$ to 1 or about 38 degrees from the horizontal, and not flatter than 2 to 1, or 30 degrees from the horizontal.

The height of banks above the surface of the water in the lateral will vary with conditions. Where the lateral is in fill, the freeboard must be greater than in cut, and where banks are of light, loose material, liable to wind erosion, they must be higher than in clay or gravel. A high freeboard is not so impor-

tant where the banks are thick and heavy as where they are thin. In any case they should have some allowance for shrinkage and wear down, and still be high enough to be safe against overtopping with the most extreme use to which the lateral can be subjected.

The top width of banks of laterals, should vary from about 3 feet for small laterals, to 5 or 6 feet for the large ones. Above this, it is generally best to make at least one bank wide enough for a roadway, at least 10 or 12 feet, but this is advisable only for the largest laterals or main canal.

As the science of irrigation develops, and as the value of water advances, it is becoming more and more common to line lateral systems, especially when located in porous soil such as sand or gravel where seepage losses would be heavy without such lining. In such cases, pipes may be freely used where the grade is abundant without excessive cost, and with important saving in maintenance. Lined canals may and should have greater depth, less bottom width, and steeper side slopes than unlined, as these differences are necessary to economize in the labor and material of the lining, and also increase the velocity obtained which is generally desirable in a lined canal, as tending to keep it clear of sediment and vegetation.

7. **Capacity of Laterals.**—The capacity of laterals is affected by several considerations, the main one being the acreage to be served. Of course the larger the tract, the larger the lateral necessary to serve it, but the ratio is not constant. A small tract is more likely than a large tract to require irrigation all at once, and hence requires a relatively larger lateral. Laterals should in general have a capacity not less than 10 second-feet, as such a quantity may be necessary for economical irrigation at one time for a single irrigator. Lateral capacity should never be less than 1 second-foot to every 60 acres served, nor less than 10 second-feet. Between these limits a rough rule is:

$$c = \sqrt{a},$$

where c = capacity of lateral in second-feet, and a = area to be irrigated in acres.

Where irrigation water carries much sediment likely to settle in laterals, it is necessary to allow a large margin to permit the use of the lateral throughout the season without shutting off the water for cleaning it. This margin is not included in the above rule, but must be added to the value of c , obtained from the formula.

In the case of the Imperial Valley, California, where irrigation is required twelve months in the year, and the irrigation water is loaded with silt, an irrigation engineer experienced in its management advocates building the lateral system in duplicate, so that one system can be used while the other is being cleaned, and irrigation water can be delivered without interruption. This, however, would require some provision for carrying water from one lateral across its duplicate, and the complications involved would hardly be justified. It is generally possible to close a lateral for a time in the slack season, which varies somewhat with the crop, but generally occurs in winter, so that cleaning may be accomplished without detriment to the crops. Various mechanical devices have also been invented by which laterals may be economically cleaned without turning out the water, and this subject will be more fully treated under the head of "Maintenance," page 518. What has been said, however, clearly shows that considerable excess capacity of laterals is a great advantage, and is never a bad investment where sediment is carried in the irrigation water.

8. Location of Laterals.—Laterals must be so located as to deliver water to the highest point of irrigable land on each farm unit, and their number and distribution will hence depend in some degree upon the probable size of farms. Where the topography will permit, they should follow property lines so far as possible, for thus they cause the least inconvenience, and give the greatest service, by reaching the maximum number of holdings. In smooth valleys it may be possible to run a lateral down each section line, thus conforming to legal subdivisions of the land, and probably farm units. It is not always desirable, however, to place lateral headings in the main canal at such frequent intervals as one mile, as such structures increase the costs of

construction, maintenance and operation, and are in some degree a menace to the continuity of service, as they usually constitute points of weakness in the canal banks. In some cases where conditions of topography or land ownership require laterals at frequent intervals, one turnout is made to serve two or more laterals, by carrying the water parallel to the main canal for the distance necessary. The objections to this are the increased seepage losses from the parallel canal and the land it occupies. These are in some cases unimportant, and in other cases may more than offset the disadvantages of additional turnouts.

The bottom of each lateral at its head should be a foot or two higher than the bottom of the main canal, so that sand moving along the bottom may be kept out of the lateral, but more than this should be avoided when possible, as any greater elevation may require the provision of a check in the main canal to permit the diversion of water into the lateral when only part capacity is being run, and checks are to be avoided when possible, especially in silt-bearing canals.

Where the slope of the country is very slight, and the grade and velocity of laterals are necessarily low, it is generally best to make each lateral serve the greatest possible area, as the larger lateral on a given grade will have a greater velocity, and the disadvantages of low velocities may be partly avoided.

Laterals are commonly located on fairly level ground, and can and should in that case be so located when feasible, that the material excavated for the channel will be just sufficient to form the banks, and the channel and banks together, form the waterway of the required dimensions and capacity. Where the ground is very broken, however, this rule, if strictly followed, may introduce too much curvature, and to secure better alinement it may be advisable to locate partly in cut and partly in fill, in which case it is often possible to balance the cut and fill so that by a moderate longitudinal haulage of material the fills may be built of the materials taken from the cuts near enough so that excessive haulage is not required. In making such location, it is always best to make the cut somewhat in

excess of the fill, rather than run any risk of having a balance the other way.

9. Abnormal Leakage from Canals.—In numerous cases serious trouble has been caused and some canals have been rendered useless, by subterranean cavities not previously observed, which are developed by the introduction of water into the canals.

On the Flathead Project of the U. S. Indian Service, a series of systems of small canals has been constructed, on which bad sink holes and cavities have appeared without any previous surface indications. On one system there is an average of twelve such holes to the mile, and these average from 12 to 15 feet deep and 200 feet long. On another small system there are about four holes to the mile, which average 6 feet deep and 100 feet long. When these canals were constructed, the ground was in apparently satisfactory condition for carrying water, being of stratified clay. In a few places minute cracks occurred in cuts about 3 feet below the surface, being so small, however, as to be hardly noticeable. When water was turned in, these cracks enlarged, and in a short time the substrata seemed to melt away, and great cavities appeared, absorbing the entire flow of the canal, which disappeared entirely. Sometimes by letting the water flow into the holes for a time they would puddle themselves, fill with water, and some repair would restore the canal. In the greater number of cases, however, no such result followed, and after developing the holes thoroughly the water was turned out, the sides of the holes blasted in, and the canal restored by careful puddling, after which no trouble was experienced.

Many sink holes occurred at the structures along the canal, where the water followed down the cutoff trenches, and thus reached the substrata. They are more numerous in cuts that reach the substrata than at other places.

The surface of the country in this region is peculiar in having a large number of potholes many of which form small ponds. These may have been formed by the collapse of underground caverns similar to those described.

In the GRAND VALLEY, on the western slope of the Rocky Mountains, near Palisade, Colorado, is a region where the soil having no abnormal appearance in its natural state, settles from 1 to 5 feet vertically soon after becoming thoroughly saturated with water. Settlers, preparing this land for irrigation, prepare to "settle" the land with as much deliberation and matter of course, as in other regions they clear or level it. The "settlement" must be performed with care and skill, or great trouble



FIG. 72.—Cavity Developed in Canal Bed, Flathead Reservation, Montana.

will result. It is necessary to saturate a large area at once in order that the settlement may be as uniform as possible, and not result in potholes and undulations that would be expensive to level. With the utmost care, however, the settlement is often uneven and erratic. This tendency, of course, introduces complications into the problem of canal construction, and it is necessary in building large canals to provide 2 or 3 feet of extra bank height, lest sudden settlement cause disastrous breaks. Occasionally cracks or cavities develop in the canal perimeter through which much water wastes, and which require careful puddling.



FIG. 73.—Cave Developed in Bottom of Canal, Flathead Indian Reservation.

The main canal of the Reclamation Project on Spanish Fork River, Utah, showed settlement of the natural ground in several places of from 1 to $2\frac{1}{2}$ feet, the subsidence appearing several weeks after the canal had been in use for the conveyance of water.

These phenomena occurred on steep side hills on what was at one time the shores of Lake Bonneville, in material varying from fine silt sand and gravel to heavy clay containing some small stones. The settlement here seems to be due to the closure of cracks and cavities left by the caving and sliding of the material on the hillside, where the meager precipitation had never furnished enough water to settle it.

The North Side Twin Falls Irrigation System, Idaho, is built in a country underlain by lava rock through which the Snake River flows in a gorge several hundred feet deep. Any crevices in the lava, therefore, have ready communication with this deep gorge, and any water in them readily escapes. Numerous springs are in evidence on the walls of the canyon.

Many cases occurred on the North Side Twin Falls canals where annoying leaks developed. These were dug down to the rock and the crevices closed with concrete, after which the earth was puddled back. The canal system as a whole now shows fair average tightness.

The canal system of the Pecos Irrigation Company near Carlsbad, N. M., where it traverses gypsum formations, was beset by leaks which enlarged by erosion and solution until they became so serious that for some distance the canal location had to be abandoned and the canal rebuilt on a lower elevation. In other places the leakage was corrected by placing a lining of concrete in the canal.

10. Construction of Canals.—Where large canals are located in heavy cutting, it is sometimes economical to employ heavy machinery, such as the steam shovel, or the drag-line excavator. The latter is especially adapted by its long boom, to conditions where a wide canal in earth requires a long reach. The steam shovel is better adapted to handling rock. These are justified only where the yardage to be moved is large. A smaller invest-



FIG. 74.—Building Lateral in Montana with Ditching Machine.



FIG 75.—Building Lateral in Montana with Elevating Grader.

ment in plant will secure economical results by using the elevating grader, which loosens the earth and elevates it into a wagon alongside, or on a canal of moderate size may deposit the earth directly in the bank. Fig. 75. Small quantities of work, especially on small laterals, are sometimes performed with the common slip scraper, drawn by two horses. But the great bulk of earthwork on canals and laterals is performed by means of the Fresno scraper (Fig. 29), a modification of the old-time Buck scraper. The Buck scraper is especially useful in sandy soil with a low lift and short haul, and cheaper work

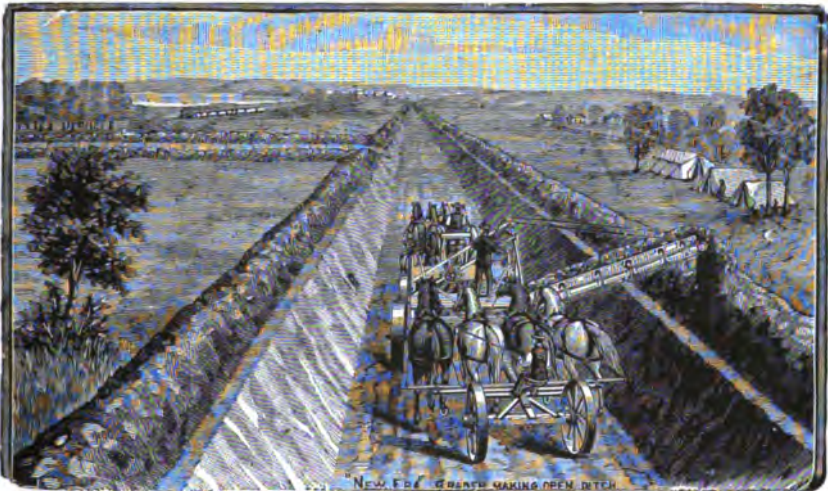

FIG. 76.—Building Canal with Elevating Grader.

has been done with it than with any other implement. A common form of Buck scraper consists of a working or frond board with an effective length of about 9 feet and a height of 22 inches. This board rests horizontally on edge on the ground and consists of two planks each 2 inches in thickness, below which is fastened an iron cutting edge which reaches 7 inches below (Fig. 194). At either end of the scraper is a cam-shaped roller 4 inches in height, on which the scraper is turned over. This board is fastened at the back to a tail board 3 feet 9 inches in length, on which the driver stands, and is drawn forward by from two to four horses, the scraper being dumped by the driver

TABLE XXX.—PRINCIPAL CANALS OF THE U. S. RECLAMATION SERVICE

Canal	Bottom, Width	Top, Width	Side Slopes	Depth	Grade	Velocity	Capacity
Salt River Project:							
Arizona Canal (Earth).....	68	82	1 : 1	7	.00025	3.87	2000
(Rock).....	55	62.6	1½ : 1	7.6	.0004	4.47	2000
South Canal.....	47	61	1 : 1	7	.0002	3.18	1200
Yuma Project:							
Main Canal (above Indian Heading).....	65	7.2	.000175	3.5	1700
(below Indian Heading).....	85	113	2 : 1	7	.0001	1.52	1500
Orland Project:							
South Canal.....	14	31.6	2 : 1	4.4	.00035	2.58	230
East Park Feed Canal.....	12	22.8	1½ : 1	3.6	.0007	3.21	200
Grand Valley Project:							
Main Canal.....	38	69.5	1½ : 1	10.5	.000094	2.53	1425
Uncompahgre Valley Project:							
South Canal (lined).....	10	28	1 : 1	9	.00048	7.0	1200
(unlined).....	30	80	2 : 1	10	.000135	2.3	1150
(lined).....	8	16.5	1½ : 1	8.5	.0016	12.0	1150
Boise Project:							
Main South Side Canal (lined).....	40	64	1½ : 1	8	.00032	6.00	2500
(unlined).....	70	100	1½ : 1	8	.00032	3.68	
Minidoka Project:							
North Side Canal (lined).....	30	44	1 : 1	7	.00025	5.79	1500
(unlined).....	50	80	2 : 1	7.5	.00015	3.08	1500
South Side Canal.....	46	6	.0002	2.88	1000

Huntley Project:									
Main Canal (lined).....	13.0	20.0	1 1/2 : 1	7	.0002	3.46	400		
(unlined).....	14.5	35.5	1 1/2 : 1	7	.0002	2.29	400		
Milk River Project:									
Dodson South Canal.....	55	74.2	1 1/2 : 1	6.4	.00014	2.18	900		
Dodson North Canal.....	24	40	2 : 1	4	.00015	1.56	200		
Vandalia South Canal.....	26	46	2 : 1	5	.00013	1.63	300		
Nelson Reservoir South Canal.....	20	37.6	2 : 1	4.4	.00025	2.04	260		
Sun River Project:									
Piskun Canal (to Sun River Crossing).....	27.5	67.1	1 1/2 : 1	13.2	.00008	2.28	1400		
(below Sun River Crossing).....	27	57	1 1/2 : 1	10	.00008	2.38	1000		
Sun River Slope.....	22	49	1 1/2 : 1	9	.0001	1.56	500		
Ft. Shaw Canal.....	15	27	1 1/2 : 1	4.0	.0003	2.06	175		
Lower Yellowstone Project:									
Main Canal.....	23.5	53.5	1 1/2 : 1	10	.000095	2.14	830		
North Platte Project:									
Interstate Canal.....	34	64	1 1/2 : 1	10	.00017	2.86	1400		
Fort Laramie Canal.....	45	81	2 : 1	9	.00009	2.54	1400		
Truckee Carson:									
Truckee Canal (unlined).....	23	49	1 : 1	13	.000154	2.8	1200		
(lined).....	20	33	1 1/2 : 1	13	.000154	4.00	1300		
South Side Canal.....	32	68	2 : 1	12	.000143	2.75	1400		
North Side Canal.....	13	39	2 : 1	6.5	.00025	2.35	400		
Carlsbad Project:									
Main Canal.....	45	67	1 1/2 : 1	4.5	.0003	1.52	450		
Rio Grande Project:									
Leasburg Canal.....	30	40	1 : 1	5	.0004	3.00	500		
Franklin Canal (lined).....	16	21	1 1/2 : 1	5	.0003	4.84	450		
(unlined).....	24	39	1 1/2 : 1	5	.0003	2.77	450		
West Side Canal.....	52	61	1 1/2 : 1	3	.00045	3.00	400		

TABLE XXX.—PRINCIPAL CANALS OF THE U. S. RECLAMATION SERVICE—Continued

Canal	Bottom Width	Top Width	Side Slopes	Depth	Grade	Velocity	Capacity
Umatilla Project:							
Feed Canal.....	13.9	35.9	2 : 1	5.5	.000202	2.19	300
Main Canal (A line).....	16.4	36.4	2 : 1	5.6	.00015	1.83	225
Klamath Project:							
Main Canal.....	44	77	1½ : 1	11	.00008	2	1300
Keno Canal.....	19	35	1 : 1	8	.00027	2.94	635
Belle Fourche Project:							
Inlet Canal.....	36.6	66.6	1½ : 1	10	.0002	3.22	1650
North Canal.....	27	48	1½ : 1	7	.0002	2.51	660
South Canal.....	16	31	1½ : 1	5	.0003	2.36	280
Strawberry Valley Project:							
Power Canal (lined).....	4	16.4	1 : 1	6.2	.001	8.0	500
(unlined).....	19	31.4	1½ : 1	6.2	3.0	550
Indian Creek Diversion Canal.....	22	41.5	1½ : 1	6.5	.00025	2.71	560
High Line Canal.....	12	26.0	1 and 1½ : 1	5.6	.0004	2.77	300
.....	20	32.3	1½ : 1	4.1	.0004	2.79	300
Okanogan Project:							
Main Canal.....	4.5	16.5	1½ : 1	4	.0006	2.44	100
Yakima Project:							
Sunnyside Canal.....	46	70	1½ : 1	8	.000102	2.32	1076
Tieton Canal (concrete lined).....	R = 4' 1.13"		6.2'	.00165	8.0	350
Shoshone Project:							
Garland Canal (earth).....	20	58.8	2 : 1	9.7	.00016	2.58	1000
(rock).....	26	30.85	1 : 1	9.7	.0005	3.72	
(earth).....	40	66	2 : 1	6.5	.00022	2.91	

merely stepping off the tail board, the forward pull upsetting it. This implement handles a load of from 1 to $1\frac{1}{2}$ cubic yards, while its average daily capacity is about 130 cubic yards. For two horses a scraper of this form is rarely made over 6 feet in length, and the angle of the face board to the ground is about 28 degrees, and is regulated by the attachment to the tail board. The Fresno scraper is most satisfactory in handling tough earth too heavy to be handled by a Buck scraper, and which would even



FIG. 77.—Building Canal with Fresno Scrapers.

give trouble to a road scraper. This implement is usually drawn by four horses and may handle 10 cubic yards per hour, with an average load of $\frac{1}{3}$ of a cubic yard. Its operation is illustrated in Fig. 77.

11. Canal Losses and their Prevention.—All earthen surfaces, whether natural or artificial, absorb more or less water when brought in contact with it. This is the principal cause of the loss of water carried in a canal. Though some water is also lost by evaporation this is generally less than 10 per cent of the quantity lost by seepage. The quantity lost varies widely

with the character of the material through which the canal runs, being greatest in coarse sand and gravel, less in loam, and still less in clay.

The clay may have as great or greater percentage of open space than the sand, but the passage of water through it is slower, owing to the extreme minuteness of the openings. In nearly all cases the losses from seepage constitute an important factor to be provided for and guarded against. The few exceptions are where a canal passes through swampy ground, in which case there may be an actual gain in water, the canal serving somewhat the function of a drain.

Where the canal carries silty water, there is a tendency to seal the pores of the channel and for this reason the seepage from a new canal is often much greater than it becomes after a long period of use, the time required for improvement depending upon the rate of silt deposit.

The seepage rate increases with increased temperature, as the water partakes to some extent of the quality of viscosity exhibited by most oils. Where conditions are favorable, much of this seepage water finds its way back to natural drainage lines.

12. Seepage Losses.—In 1912 and 1913, Bark measured 118 sections of canals in Idaho for determination of seepage losses. These canals varied in capacity from 1 to 3200 cubic feet per second and the tests included 287 miles of length.

Seven of the canals in wet ground showed a gain. From the 109 canals showing a loss, the following results were obtained:

	Per Mile per cent	Loss per Sq. ft. per 24 Hours. Cu. ft.
Maximum loss	58.3	6.32
Average loss	7.4	1.21

This average, of course, includes many canals with losses so large as nearly to destroy their value. In fact all the canals showing losses greater than 1.5 feet in depth per day over the wetted area should be classed as poor in holding quality, and improvement by silting, puddling or lining should be given

consideration. For unlined canals the following classification may serve as a rough guide:

Poor, where losses exceed 1.5 feet in depth per day.

Fair, where losses are from 1 to 1.5 feet per day.

Good, where losses are from .5 to 1 foot per day.

Excellent, where losses are less than .5 foot per day.

The wisdom and character of improvement will depend in each case not only upon the losses, but also upon the value of the water to be saved and the damage being done by the seepage, and whether other economies are to be secured thereby.

13. Seepage Formula.—The following formula is proposed as representing the results of existing data, to be used in estimating seepage to be expected from contemplated canals:

$$S = C\sqrt{d} \frac{PL}{4,000 + 2,000\sqrt{V}}, \text{ where}$$

S = Seepage in cubic feet per second;

C = Coefficient depending on material of canal;

d = Mean depth of water in feet;

P = Wetted perimeter in feet;

L = Length of canal in feet;

V = Mean velocity of water in canal.

Values of C are as follows:

$C = 1$ = Concrete, 3 to 4 inches thick;

$C = 4$ = Clay puddle, 6 inches thick;

$C = 5$ = Thick coat of crude oil, new;

$C = 6$ = Cement plaster, 1 inch thick;

$C = 8$ = Clay puddle, 3 inches thick;

$C = 10$ = Thin oil lining; cement grout;

$C = 12$ = Clay soil, unlined;

$C = 15$ = Clay loam soil, unlined;

$C = 20$ = Medium loam, unlined.

$C = 25$ = Sandy loam, unlined;

$C = 30$ = Coarse sandy loam, unlined;

$C = 40$ = Fine sand, unlined;

$C = 50$ = Medium sand, unlined;

$C = 70$ = Coarse sand and gravel, unlined.

Care should be taken not to give too much weight to the above arbitrary values of C , as the seepage depends not only upon the surface of the canal perimeter, but also to some extent upon its backing. Any one of the linings above listed will make a tighter canal if placed on a clay or loam soil, than if it has a backing of sand or gravel, which transmit the water freely.

14. Canal Lining.—It is becoming more and more the practice to line irrigation canals and laterals, mainly for the reasons following:

1. To prevent loss of valuable water.
2. To avoid softening the lower bank on side hills, and consequent sloughing.
3. To avoid waterlogging land and thus destroying its fertility.
4. To prevent erosion of the canal bed where high velocities are convenient or economical.
5. To reduce friction and thus avoid excessive excavation in heavy rock cuts.

Seepage from canals located on side hills often threatens the safety of canals by softening the lower bank and causing it to slough or slide. Where water is valuable the cost of lining is often less than the value of the water thereby saved. Such cases are becoming more frequent as water increases in value. Many cases occur where seepage from canals saturates and waterlogs valuable land at lower levels, and lining may be required to prevent this. Where the topography of the country requires or permits a very heavy grade to be given a canal, concrete lining may be necessary to prevent erosion, and by thus utilizing excess grade the cost of drops is saved. In heavy rock cuts it may be found economical to provide a lining to diminish friction and thus secure a sufficient velocity and discharge with less cross-section so as to save expensive excavation.

The existence of one or more of the various reasons may justify the lining of a canal and lateral system throughout. This has been done by the U. S. Reclamation Service where the land is very sandy, upon the west extension of the Umatilla Project covering about 10,000 acres. It is also frequently done in

Southern California where water is very valuable. It is thus possible to eliminate many drops that would otherwise be required upon the lateral system, and to employ velocities higher than earth sections would permit, and thus keep the canals free from silt, trash and vegetation.

Canal lining is usually of cement mortar or concrete, but in some cases other materials have been used. Where a canal is constructed on a long fill which might settle unevenly and thus crack a concrete lining, and where seepage would endanger its safety if unlined, lumber is sometimes used for lining, with the expectation of replacing this when decayed, with concrete lining,

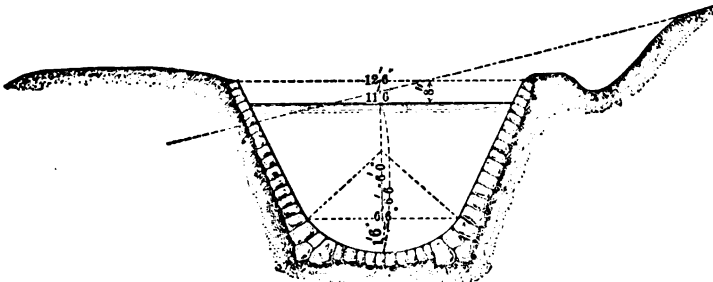

FIG. 78.—Cross-section of Lined Channel, Santa Ana Canal.

after the bank is well settled. Wooden lining may be used where the ground-water is impregnated with salts to such extent as to disintegrate concrete lining.

Concrete linings are usually made from 2 inches to 4 inches in thickness, and joints running across the canal are necessary at intervals of from 20 to 40 feet, to prevent irregular contraction cracks. It is best to place the concrete in cold or cool weather, to avoid subsequent cracking, and to build alternate slabs which are allowed to harden before the intermediate slabs are placed. In cold climates, where hard freezing is common, it may be advisable to reinforce the slab with steel fabric or mesh to hold it together against heaving. If there is possibility of collection of water behind the slabs, this may be relieved by the provision of one or more weep holes near the center of the bottom slabs, and in the side slabs near the bottom. The joints may be relied upon to allow the escape of water in their vicinity.

If the side slopes are made 45 degrees or flatter, they may readily be placed without forms, by taking care to have the consistency of the concrete suitable to such use. If the depth of cut requires for economy a steeper slope than 45 degrees, it will be necessary to provide forms for the lining, which will increase its cost. The outside bank can sometimes be made flatter, and the form avoided.

In countries where the winters are mild, a very thin lining has sometimes been used made of cement mortar or of concrete with small aggregates, plastered directly on the earth bottom and slopes, from $\frac{3}{4}$ to $1\frac{1}{2}$ inches thick, without forms, and without reinforcement. If this is carefully placed in cool weather, and protected from drying until thoroughly set, good results may be obtained very cheaply. Such linings have been extensively and successfully used on the Umatilla Project of the U. S. Reclamation Service. They would not succeed, however, where the ground is subject to heaving.

In cases where ground-water is strongly impregnated with alkaline sulphates which threaten to disintegrate the concrete lining, the difficulty may be met by providing free drainage for the ground-water, and by placing 2 or 3 inches of screened gravel under the concrete slabs to facilitate the escape of ground-water through tiling placed for the purpose.

In some cases where canals are located on steep side hills, they may be threatened by slides of snow or earth from the steep hillside above, and a protective covering may be necessary to prevent disastrous breaks from this cause. A reinforced concrete arch has been successfully used for this purpose in the Spanish Fork Valley by the U. S. Reclamation Service.

Concrete lining should be placed only on well-settled banks; otherwise unequal settlement will be likely to rupture the lining, thus reducing its efficiency, and hastening disintegration.

The earth upon which the lining is built should be carefully smoothed and rolled, and if dry it is best to moisten it before placing the concrete, as dry earth will absorb some of the moisture which the concrete requires for the chemical process of setting. The concrete mixture should be about one part of cement to

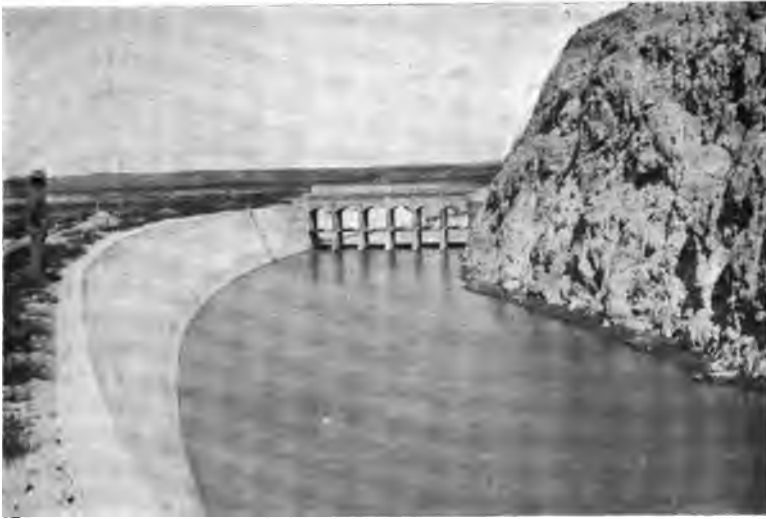

FIG. 79.—Check Gates and Canal Lined on One Side. Interstate Canal, Nebraska-Wyoming.



FIG. 80.—Semicircular Concrete-lined Section of Main Canal, Umatilla Valley, Oregon.

two of sand and four of gravel. The diameter of the largest particles of the gravel should not exceed one-half the thickness of the lining and where the lining is less than $1\frac{1}{2}$ inches thick, it is usually best to omit the gravel, and use a mortar of 1 part cement to three parts of well-graded sand.



FIG. 81.—Concrete Lining, Truckee-Carson Canal, Nevada.

A typical paved lining is that given the Santa Ana canal in California, in alluvial soil, sand, and gravel. This canal is almost wholly in excavation (Fig. 78); the water is permitted a velocity of 5 feet per second, and the depth is as great as $7\frac{1}{2}$

feet for a bed width of $6\frac{1}{2}$ feet and top width of $12\frac{1}{2}$ feet. In order that the lining may have a stable footing and the bottom be less liable to bulge, this is curved downward with a versed sine of $1\frac{1}{2}$ feet, forming thus a subgrade of that depth. The banks are 2 feet higher than the water surface, and are built on side slopes of 2 on 1. The earth excavation had a bottom width of 7 feet and the same slopes as above, and was trimmed at bottom to the lining, which consists of cobbles and bowlders laid in mortar, grouted and faced with cement plaster.

• On the Tieton canal, Washington, of the Reclamation Service, the lined sections in earth and loose rock are semicircular (Fig.

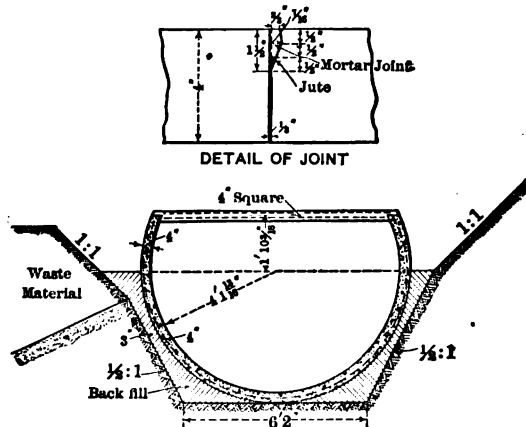

FIG. 82.—Reinforced Concrete Canal Lining. Tieton Canal, Washington.

82). The lining is of reinforced concrete, 4 inches in thickness, and extends 1 foot 10 inches above the center of the circular section. The upper edge is cross-braced every 2 feet by a 4-inch square brace. The diameter of the lined section is 8 feet 2 inches, depth of water 5 feet 3 inches, area 36 square feet, velocity 9 feet per second, and discharge 326 second-feet. By comparison the unlined section of the same canal has an area of 120 square feet and velocity of 2.5 feet per second.

Below the Assuan dam in upper Egypt is a canal built in shifting sand by erecting on the surface a semicylindrical flume of sheet steel and then banking the sand against it to the level of

its top. This steel canal is 19 feet 8 inches in diameter with 1 foot 8 inches straight sides at top, making a total depth of 21 feet 4 inches. The inner shell of $\frac{1}{4}$ -inch steel plates is riveted to outer semicircular ribs of heavy T-rail placed $2\frac{1}{2}$ -feet centers. The top is braced with 3-inch flat and 3 inch by $2\frac{1}{2}$ inch angle iron. The canal rests on a wall of concrete beneath its center and has expansion joints every 330 feet.

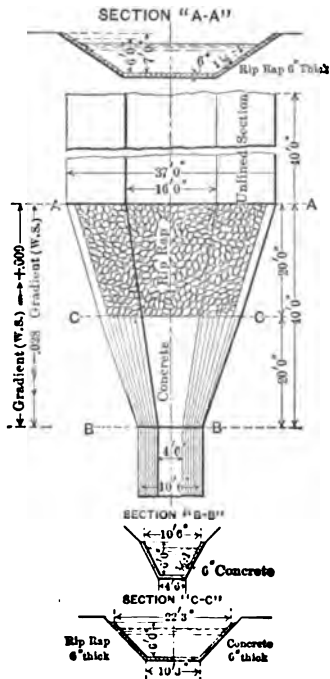

FIG. 83.—Transition from Rock to Earth Cross-section, Lined Canal, Reclamation Service.

one-tenth as great relatively as from those that have not been lined.

On the main canal of the Carlsbad, New Mexico project, 37,300 linear feet of canal were lined with concrete two-tenths of a foot in thickness. This required 7,191 cubic yards of concrete at \$13.67—\$98,313, or \$2.64 per linear foot, or, \$13,820 per mile.

The lining of the laterals on the same project, was accom-

Experiments conducted by B. A. Etcheverry in Southern California to determine relative percolation from lined and unlined ditches showed the following relative efficiency ratios. Using unlined earth channels $e = 1.0$; heavy oil lining, $3\frac{1}{2}$ gallons per square yard, $e = 2.0$; clay puddle, $e = 1.8$; cement concrete 3 inches thick, $e = 7.2$.

Careful cost records kept on the Orland Irrigation System embracing both unlined canals, and others lined with concrete, show a maintenance cost for the unlined canals of \$123 per mile per annum, and \$10 for the lined canals. The lining has also reduced the seepage losses, until this loss from the lined canals is about

plished at a cost of \$10.37 per cubic yard of concrete of a thickness of .2 of a foot.

The lining of the main canal on the Umatilla project, Oregon, with concrete, 3 inches thick, in the proportion of 1 : 3.5 : 5.2, cost \$8.16 per cubic yard, and carried a little more than a barrel of cement to the cubic yard. The side slopes were $1\frac{1}{2}$ to 1, and were lined without forms.

The main canal of the Boise project was lined with concrete 4 inches thick, with joints at 16 foot intervals. The records show the following costs:

	Cost per Cu. yd. of Concrete	Cost per Linear Foot of Canal
Plant charge.....	\$0.858	\$0.801
Gravel and sand.....	1.079	1.008
Cement.....	2.963	2.767
Water.....	0.222	0.207
Forms.....	0.177	0.165
Mixing and placing.....	1.603	1.597
Supplies.....	0.107	0.100
Superintendence and accounts.....	0.172	0.161
Engineering.....	0.098	0.092
Total for concrete.....	\$7.279	\$6.798
Preparation of foundation.....	2.349	2.195
Grand Total.....	\$9.628	\$8.993

The U. S. Reclamation Service has in several instances employed clay puddle with satisfactory results, to tighten the open soil of the canal perimeter. Puddle lining, 4 inches thick, has cost on an average about 1 cent per square foot, exceeding this where the haul for the clay was long, and being less where all the conditions were favorable.

On the Grand River project in Colorado, some of the canal location was in shale with many open seams which wasted much water to the injury of lands below upon which the water emerged, forming bogs or swamps. After some exposure to the air, the shale disintegrated to some extent on the surface, and then was

plowed, and after some weathering was harrowed, the water turned in, and harrowed again, forming a clay puddle which was very effective in reducing the seepage. In addition to this muddy water was turned into the canal and ponded at points where seepage was great, and by depositing its mud greatly reduced the seepage. Similar measures have been employed in many other places with good results.



FIG. 84.—Lining Canal with Concrete, Idaho.

On the Minidoka project clear water was carried in a canal built partly through coarse sand in which losses were very great, and it was after several years decided to try to reduce the losses by depositing silt in the canal. To accomplish this, a deposit of clay was selected near the canal, and water was pumped from the canal through a hydraulic monitor and the clay was by this means washed into a flume and carried into the canal and deposited by ponding or checking the canal where the puddle was needed. The result of this work was the

deposit of about 100,000 cubic yards of clay over the perimeter of the canal at a cost of about 20 cents per cubic yard. Where this was done the losses from the main canal were reduced from 110 cubic feet per second in 1912, to 71 cubic feet per second in 1915, besides important reduction of losses in the laterals.

15. Amount of Return Seepage.—The State Engineer of Colorado conducted measurements of seepage water returned to the South Platte and Cache la Poudre rivers during the years 1890 to 1893 inclusive. These showed a constant increase in the amount of seepage water returned to these streams and available for diversion below the points of measurement.

Prof. L. G. Carpenter sums up his investigations on this subject thus: "There is real increase in the volumes of streams as they pass through irrigated sections. This increase is approximately proportional to the irrigated area. The passage of seepage water through it is very slow. The amount of seepage water slowly but constantly increases. This seepage water adds to the amount of culturable land. On the Cache la Poudre River about 30 per cent of the water applied in irrigation is returned to the river."

Investigations of a similar nature conducted by the Utah Agricultural Experiment Station and by others point in the same direction. The amounts of returned water by seepage indicated in the above experiments must not be taken as a criterion of what may be expected in other regions. The circumstances surrounding these cases were especially favorable for the return of seepage water. In other regions the amount of seepage water returned may diminish to practically nothing, dependent upon the soil, quality of underlying strata, their slope and inclination, and the area of drainage basin above and tributary to them.

Observations made at storage reservoirs for New York and Boston and some other Eastern cities show clearly that the amount of seepage water returned from the surrounding country to reservoirs which have been drawn down for service varies between 10 and 30 per cent of their capacities. This is largely due to the fact that the water plane of the surrounding country

is filled up from the reservoir as well as from seepage from the adjacent country. Measurements of volume in the Sweetwater reservoir in Southern California show that after water ceases to be drawn from the reservoir it begins to refill while no water is entering from streams, and similar additions from seepage have occurred in other reservoirs. As a result, the actual available capacity of a storage reservoir may be found to be greater than its measured capacity.

REFERENCES FOR CHAPTER XIII

- FORTIER, SAMUEL. Concrete Lining as Applied to Irrigation Canals. Bulletin No. 126, U. S. Office of Experiment Stations.
- MEAD AND ETCHEVERRY. Lining of Ditches and Reservoirs to Prevent Seepage Losses. Bulletin No. 188, Agricultural Experiment Station, Berkeley, California.
- ETCHEVERRY, B. A. Conveyance of Water. McGraw-Hill Book Company, New York.
- CARPENTER, L. G. Losses from Canals from Filtration or Seepage. Bulletin No. 48, State Agricultural College, Fort Collins, Col.
- MORITZ, E. A. Seepage Losses from Earth Canals. *Engineering News*, Aug. 28, 1913.
- HANNA, F. W. Water Losses in Irrigation Canals, and Methods of Prevention. *Engineering and Contracting*, Oct. 9, 1912.
- FORTIER, SAMUEL. Conveyance of Water. Water Supply Paper 43, U. S. Geological Survey.

CHAPTER XIV

CANAL STRUCTURES

1. Classification.—The term “Canal Structure” is usually applied to all structures necessary in connection with the canal, aside from the earthen waterway itself, and its lining, which may be classified as follows:

1. Works for controlling canal water.
 - a.* Headworks.
 - b.* Turnouts.
 - c.* Spillways.
 - d.* Drops, and checks.
 - e.* Measuring devices.
2. Drainage crossings.
 - a.* Flumes, and superpassages.
 - b.* Inverted siphons.
 - c.* Culverts.
 - d.* Pipes.
3. Highway crossings.

2. Location of Headworks.—The first requirement for a suitable diversion point is permanence of the stream channel, so that the stream will not leave the works after they are built, nor wash them out. Preferably both sides of the stream should be rock or hard gravel not easily eroded. It is especially desirable that the side on which the regulator is built should be of this character, for the safety of the works, which should, if possible, be founded upon rock.

It is desirable that the ground in which the first few rods of the canal is built should be of firm material, and so high as to be not subject to overflow from the stream, so that the canal will thus be protected until it gets away from the river.

The diversion works should be located so far as physical conditions will permit, at such an elevation as to command the land to be irrigated, with ample grade allowance for the canal, without an excess of grade. The location should permit of the construction of regulating works parallel to the stream so that the current of the stream may have a clear sweep past the regulator, and close to it, to facilitate sluicing away sand and gravel that threaten to pass into the canal.

It is always desirable to secure rock foundation for the diversion weir, but if this is impracticable, a safe dam can be

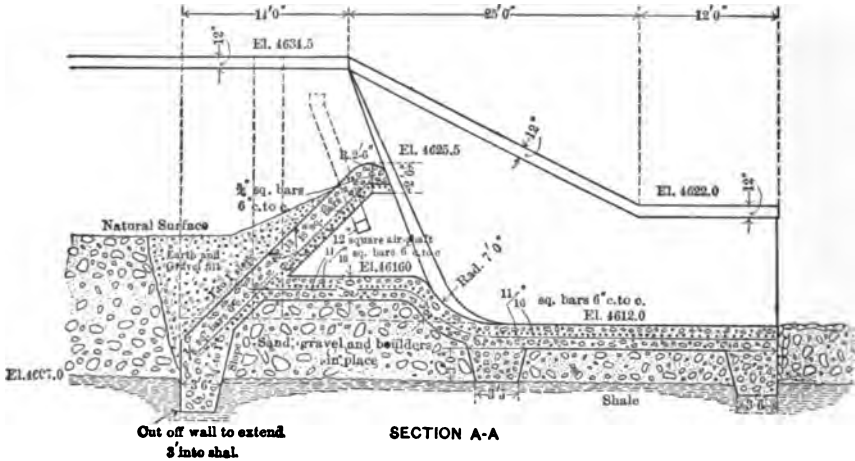

FIG. 85.—Cross-section of Corbett Weir, Shoshone Project, Wyoming.

built by taking proper precautions, upon gravel, sand, silt or clay.

3. Canal Headgates.—Every canal should have one or more headgates so located that the quantity of water admitted to the canal shall be at all times under control.

On streams carrying sediment or transporting sand or gravel, means should be provided for preventing the entrance to the canal of sand and gravel likely to deposit and clog the canal. The lighter silt which is easily carried in suspension is not so objectionable, as it can be mostly carried through the canals and laterals and deposited on the fields, where it has considerable

fertilizing value. The heavier silt, sand and gravel are more likely to be deposited in the canals and entail great expense for removal, and even if carried to the fields are nuisances which should be eliminated at every opportunity, and if possible they should be left in the river bed. To accomplish this three precautions may be employed:

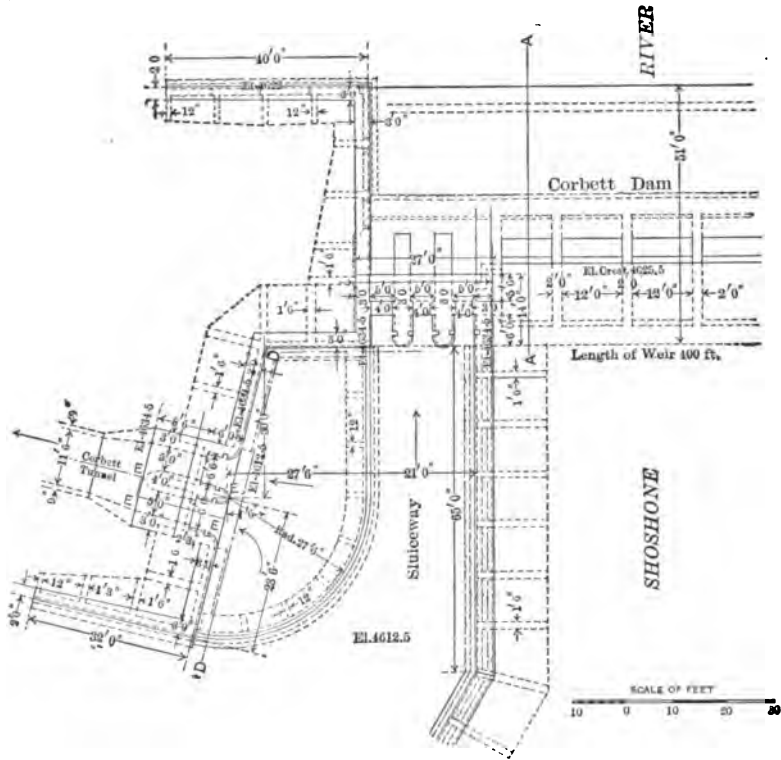

FIG. 86.—Plan of Corbett Dam and Headworks, Shoshone Project, Wyoming.

1. The stream velocity may be reduced before entering the canal, thus causing the settlement of the heaviest particles in suspension.

2. The water entering the canal may be required to flow in a thin sheet over the top of a long weir so that only the surface water can enter the canal, as the surface carries only the lightest sediment.

3. Means should be provided for sluicing the deposited sand away from the headworks, and causing it to pass on down stream.

To secure these conditions, a diversion dam is necessary, to form a settling basin, and to furnish head for sluicing it out when needed. The gates through which the water enters the canal should be parallel to the stream, so that the water passing into the canal shall move normal to the river channel. Immedi-

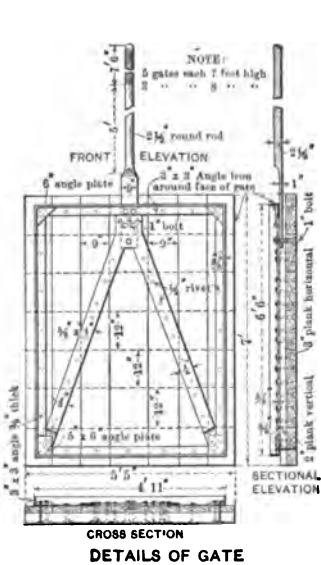

FIG. 87.

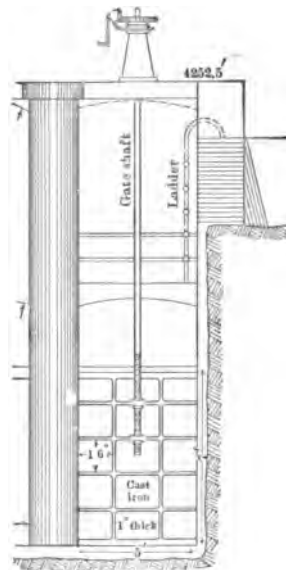

FIG. 88.

FIG. 87.—Wooden Gate, Leasburg Canal Regulator, Rio Grande, N. M.

FIG. 88.—Iron Regulator Gate, Minidoka Canal, Idaho.

ately adjacent to the entrance of the canal, and at right angles thereto, at the end of the diversion dam, one or more sluice gates should be placed, with their sills at the normal bed of the river, which can be quickly opened and as readily closed. When opened the water will rush through under the head equivalent to the difference of water level above and below the dam, and the high velocity thus generated will scour the channel immediately in front of the entrance to the canal, and thus furnish

capacity for subsequent use as settling basin, to be again sluiced out when filled.

The entrance to the canal should be controlled by flash boards or some similar device so arranged that the water will flow into the canal as a thin film from the surface only, and thus carry on a skimming process, the heavier sediment being

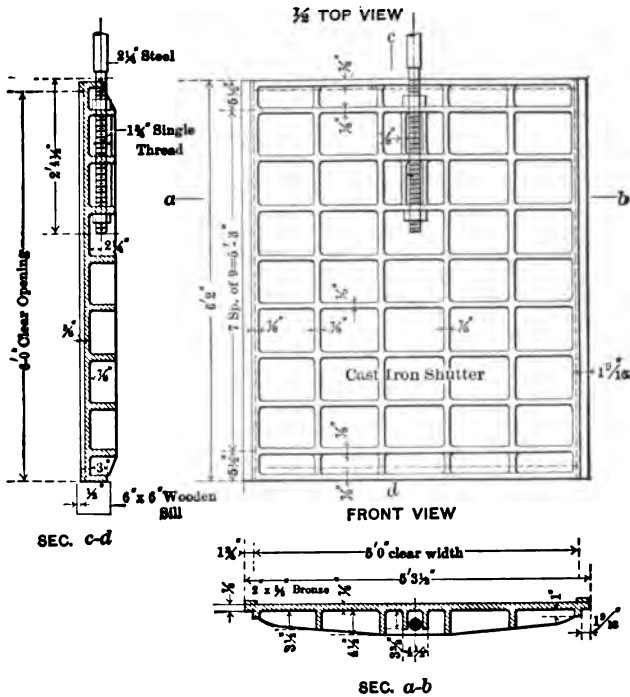

FIG. 89.—Cast-iron Sluice-gate, Interstate Canal, Nebraska-Wyoming.

generally some distance below the surface, especially after the velocity of the water has been checked.

One of the best examples of the system here described is in use at the Laguna Dam on the Colorado River, at the head of the Yuma main canal (Fig. 94.) In this case the canal entrance or "regulator" is controlled by flash boards. On the Carson River the regulator is a movable gate which is depressed into a chamber below the canal bed to open the gate, and is

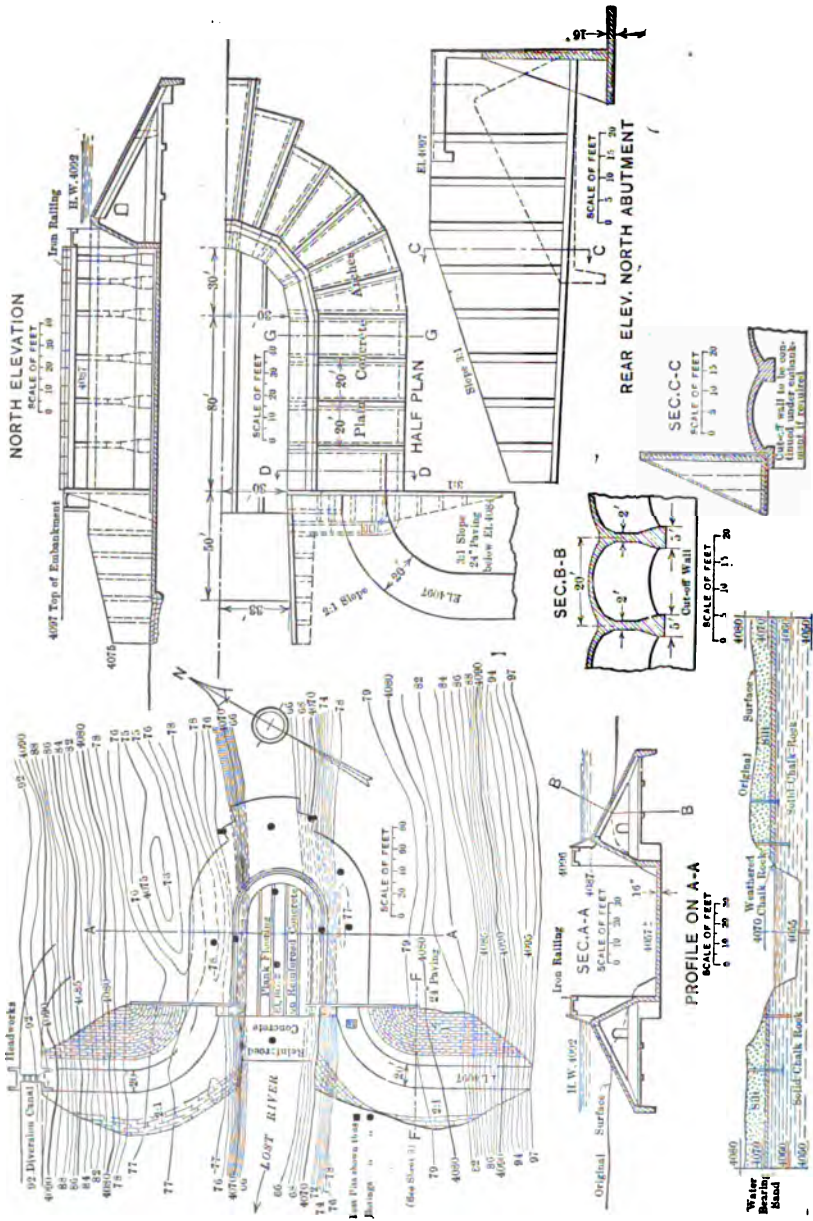

Fig. 90.—Diversion Works, Lost River, Oregon.

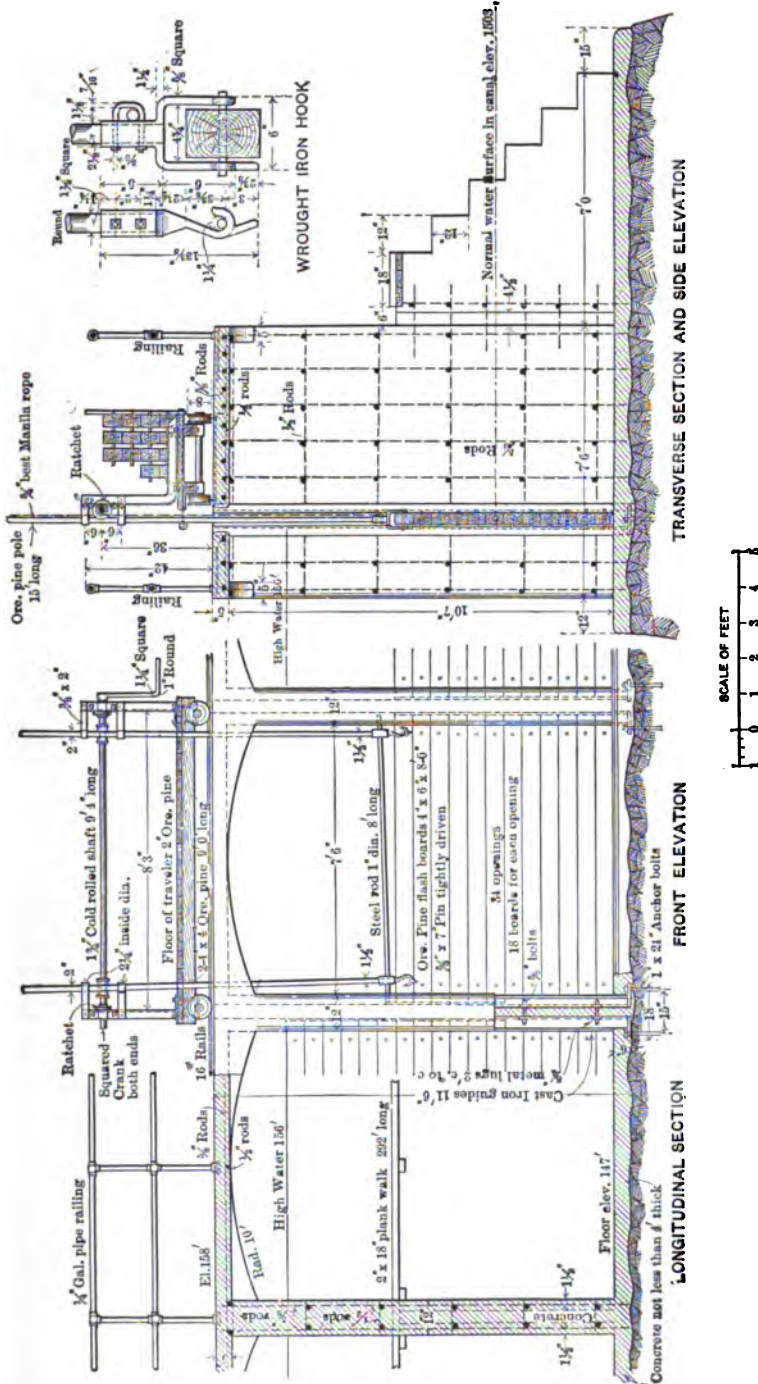

FIG. 91.—Regulator Gates, Laguna Weir, Colorado River.

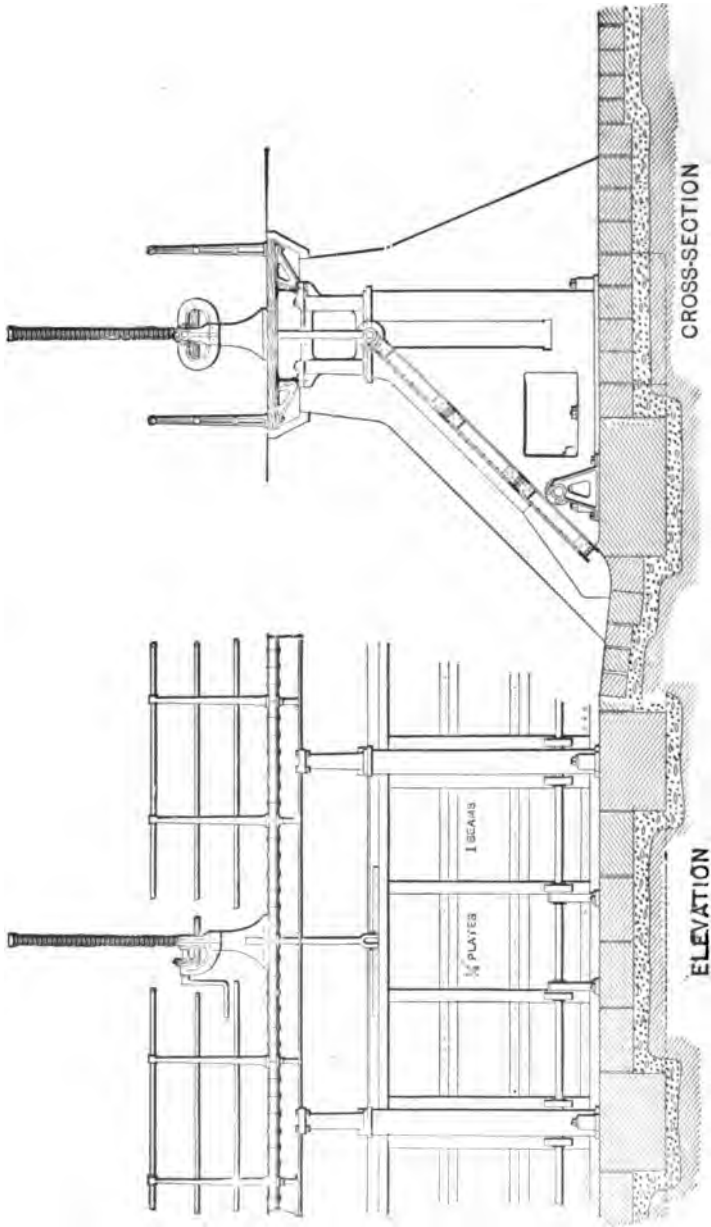

FIG. 92.—Inclined, Falling Regulator Gates, Goulburn Canal, Australia.



FIG. 93.—Boise Dam, Canal and Headworks, Boise Valley. Headgates in line with Dam.



FIG. 94.—Regulating Gates and Sluice Gates, at Right Angles to Each Other, Yuma Main Canal, California.

lifted to close it, the water entering over the top of the gate like a weir, which thus exercises the skimming function. A similar effect is obtained by inclined gates at the head of the Goulburn Canal, Australia (Fig. 92). Flash boards, though cheap, are slow and laborious in manipulation, and except on very silty streams, the practice is usually to use ordinary iron gates as regulators.

Where the conditions of water supply are such as to require the diversion of all the water in the stream most of the time,



FIG. 95.—Whalen Diversion Dam and Headgates, Normal to Dam. North Platte River, Wyoming.

there is little virtue in the skimming process. Headgates are usually, therefore, of the ordinary type, which open at the bottom by raising on a stem, and are sometimes called under-shot gates, because the water passes under them.

Sluicing devices are most needed upon streams carrying much sediment like those of the Southwest, but are also very useful upon many Northern streams which may generally run clear, but nevertheless carry much sand and gravel by rolling

along the bottom, and if this is allowed to enter the canal, it causes much annoyance and expense. Instances are not rare where the gravel carried into the canal during the June rise so depleted its capacity that it could not carry the water needed for irrigation, and it became necessary to close the canal and clean it during the height of the irrigation season, at great expense, and to the great injury of crops.



FIG. 96.—Sprague River Dam, Klamath Indian Reservation, Oregon.

The headworks of a large canal are of great importance for protecting the canal against floods, and for regulating the flow into the canal. They should be founded upon rock if possible, and should be of masonry of gravity design, heavy enough to resist any tendency to shear, slide or overturn when subjected to the maximum pressure which can occur. They should be flanked with ample wing walls and unless founded on rock should have deep cut-off walls to prevent seepage around or under them.

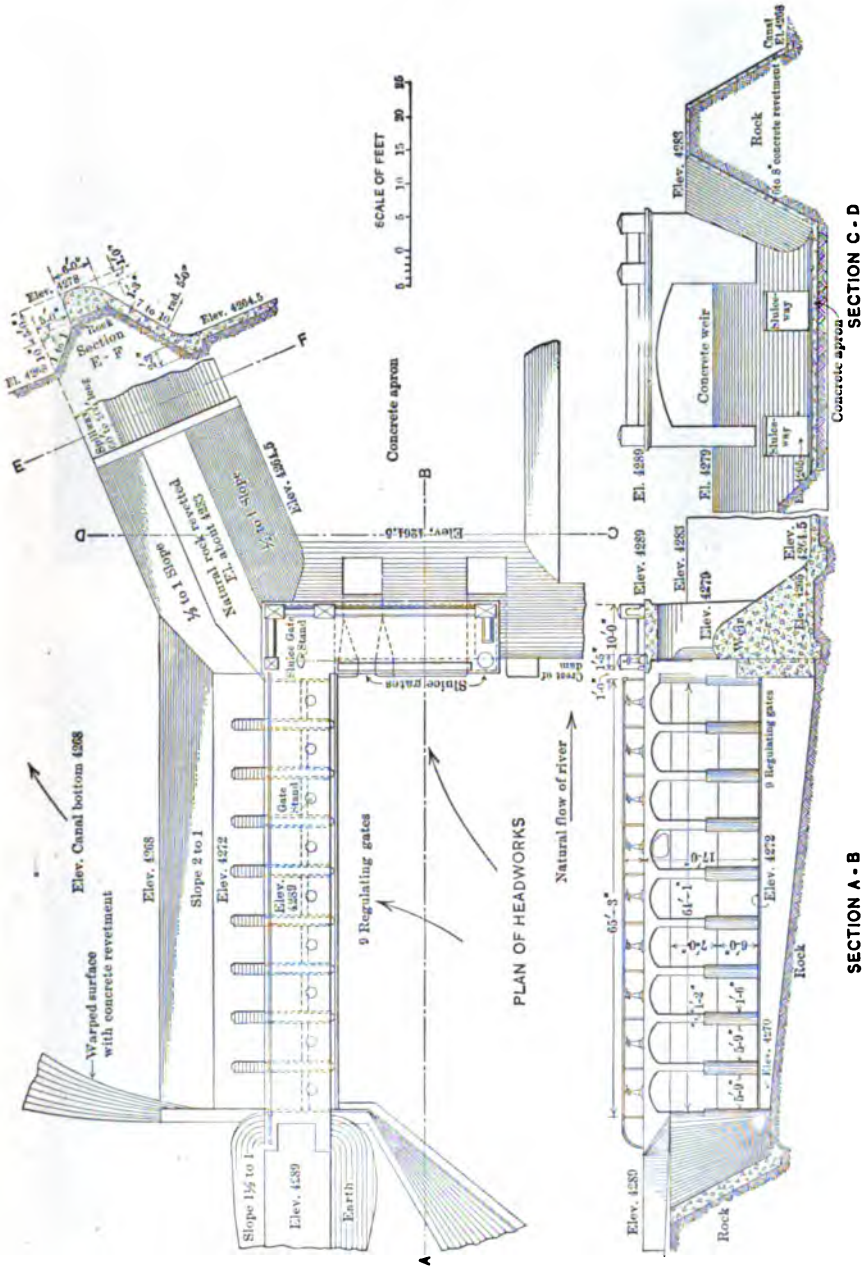

Fig. 97.—Plan and Elevation of Headworks, Interstate Canal, North Platte River, Wyoming.



FIG. 98.—Jackson Lake Dam, Downstream Face, Wyoming.



FIG. 99.—Headgates and Sluice Gates, Montrose and Delta Canal, Uncompahgre Valley, Colorado.



FIG. 100.—Division Gates and Drops on Tsar Canal near Byram Ali, Murgab Valley, Turkestan.



FIG. 101.—Headworks of Sultan Yab Canal at Sultan Bend Reservoir, on Murgab River, Turkestan.

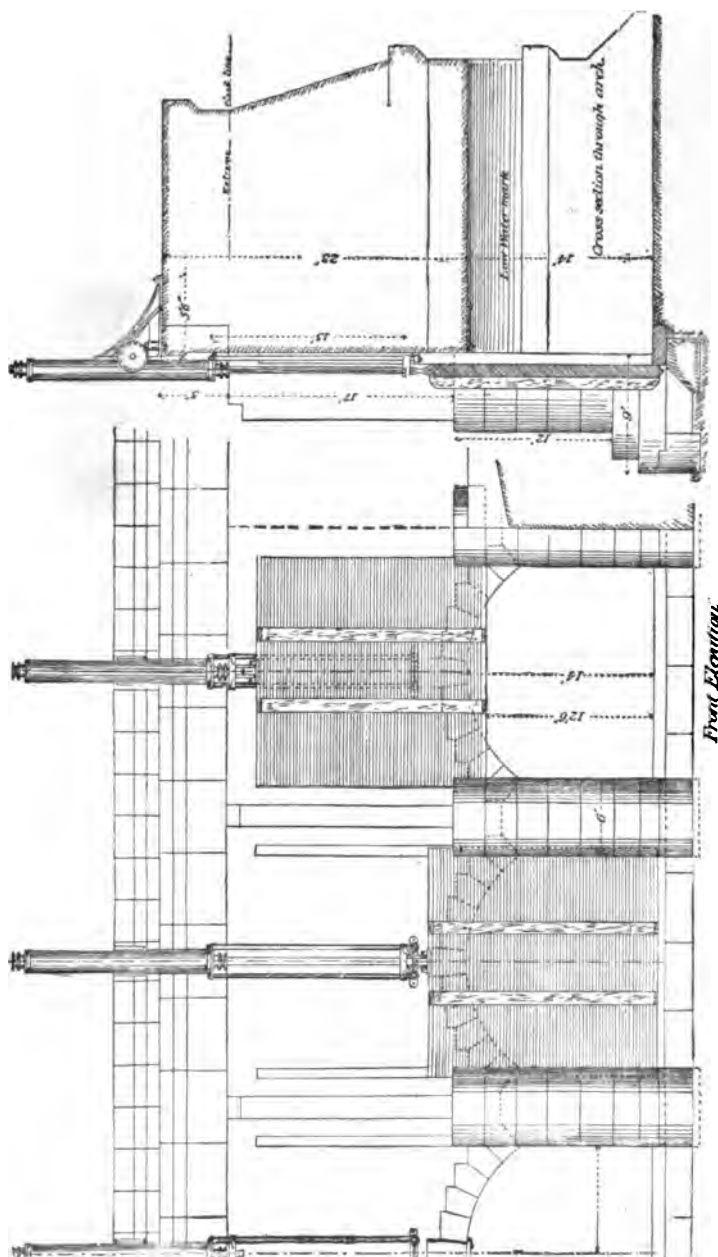

FIG. 102.—Cross-section and Elevation of Regulator Gates, Folsom Canal.

4. Turnouts.—Each lateral branch from the main canal and all the sublaterals down to the individual farm laterals, should be provided with regulators. They are similar in function to the regulator at the head of the main canal, but differ widely

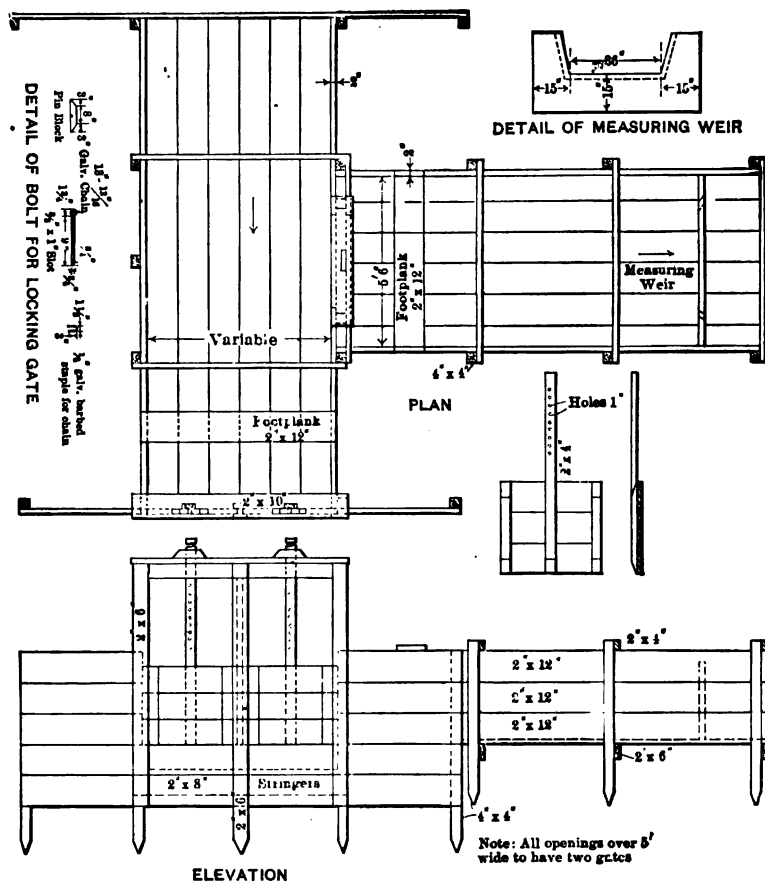

FIG. 103.—Wooden Head to Lateral, Sun River Canal, Montana.

from it, not only in size, but in not being required to withstand the torrents of the river, and instead of keeping out sediment, should facilitate its passage through the system and its deposit upon the land. They are consequently best of the undershot type, so as to stop as little of the sediment as may be. Turn-

outs are usually located in an artificial bank of a canal, and must be carefully designed and built with a view to preventing the percolation of water around them. They must be provided with wingwalls with earth carefully puddled against them. The tendency of percolating water is to follow in straight or nearly straight lines the seam formed by the contact of the structure with the bank, and this tendency can best be met by providing numerous abrupt angles to interrupt the path around the struc-



FIG. 104.—Check and Farm Turnout with Inclined Valve.

ture. If the structure is of concrete, angular corrugations may be produced by nailing 2- by 4-inch lumber vertically to the forms against which the concrete is afterward built, and into these corrugations the earth fill should be carefully puddled and tamped.

The smaller turnouts are often in the form of a box or pipe leading through the bank, with a gate on the upper end. Earthen sewer pipe is best for this purpose, and standard steel gates

and gate frames are on the market which are conveniently fastened to such pipes.

Turnouts should be located at or near the bottom of the canal from which they take water, in order that a supply of water may be drawn when the canal is running at part capacity. Where the elevation of the land is too high to permit this, it may be necessary to locate the turnout several feet above the bottom of the canal, and such cases will require the provision of



FIG. 105.—Cast-iron Valve on Small Lateral Turnout.

a check in the canal below, in order to hold the water up and enable a supply to be taken when the canal is only partly filled. Such checks are, however, to be avoided if possible.

In early canal building most of the structures were made of wood, and this is still common practice with the small lateral turnouts, which can be replaced with little interference with the water service. All large turnouts which serve important areas, and require considerable time for renewal, should be built of

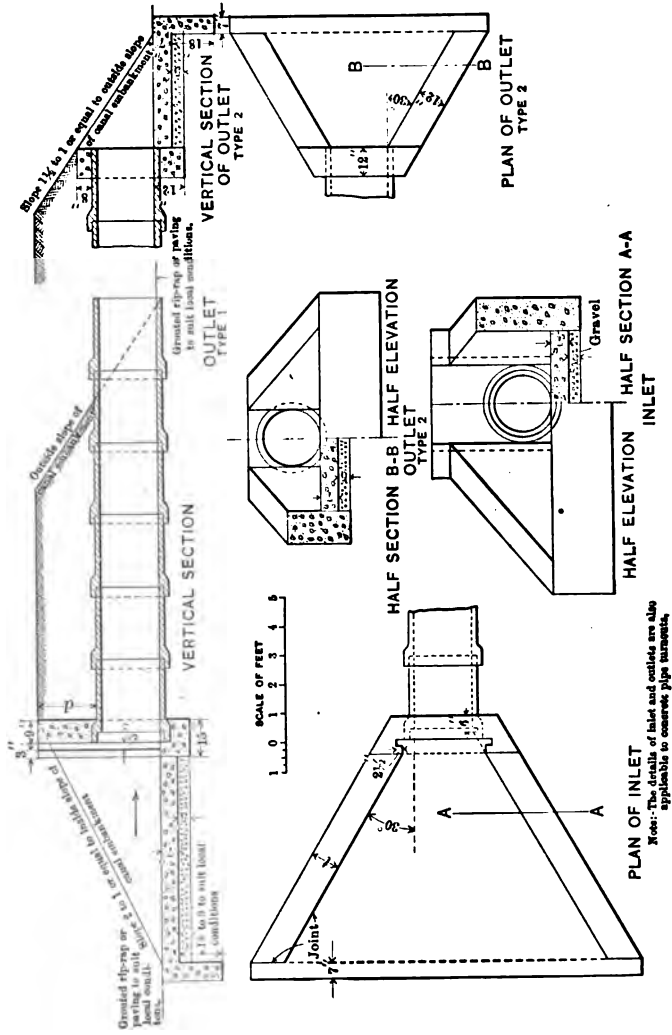

FIG. 106.—Standard Turnout, Vitrified or Concrete Pipe, U. S. R. S.

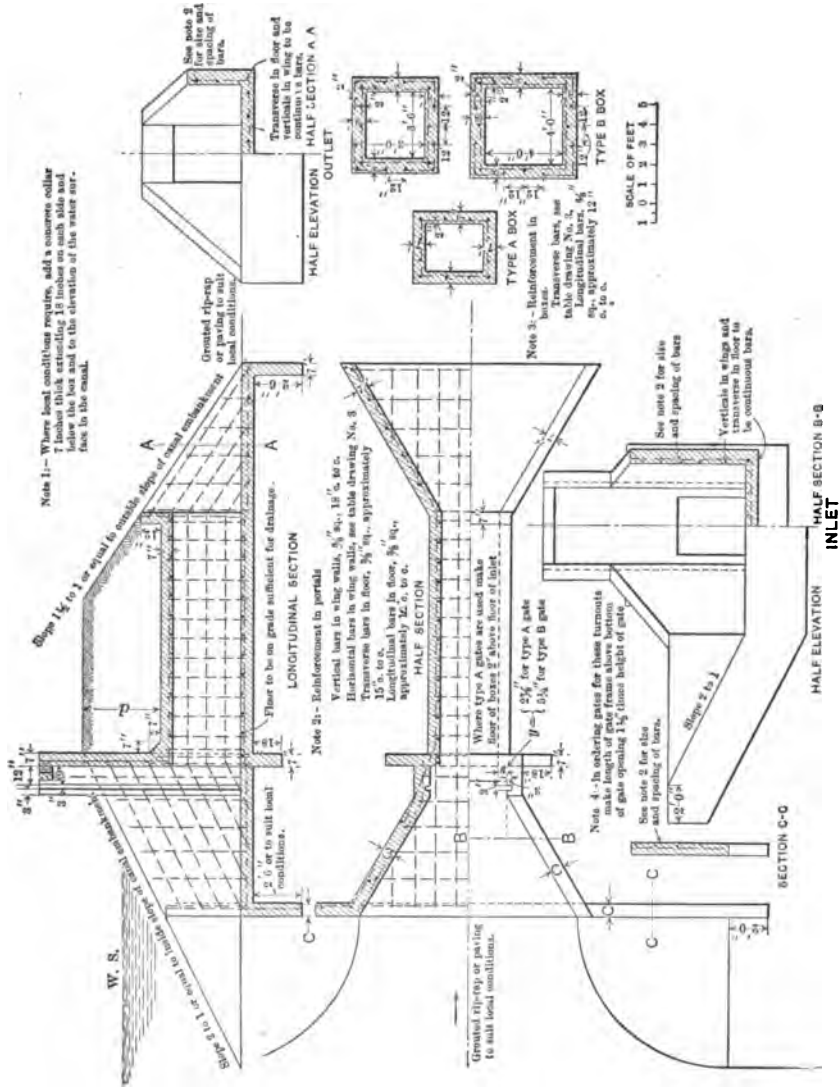

FIG. 107.—Standard Turnout, Box Concrete, U. S. R. S.

concrete or other permanent construction. The capacity of the conduit should be sufficient to take the required amount of water at the lowest stage of the canal.

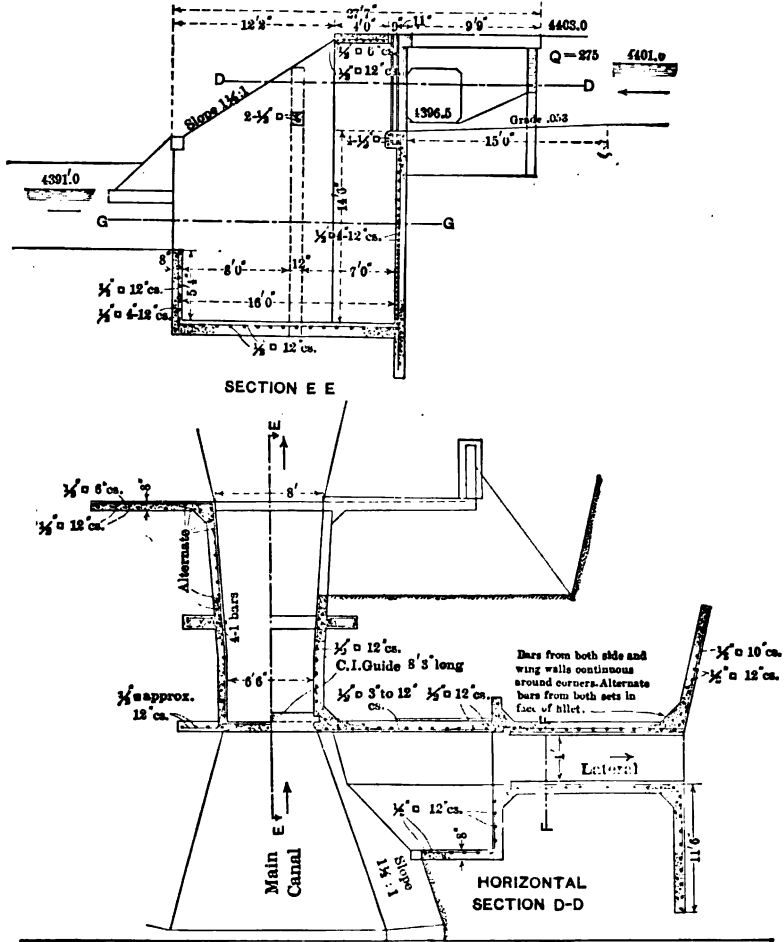

FIG. 108.—Reinforced Concrete Turnout with 10-Foot Drop, Garland Canal, Wyoming.

The velocity of flow may be obtained from the formula $V = C\sqrt{2gh}$, where h is the available head in feet, g represents the acceleration of gravity, in feet per second, and C represents a

constant depending partly upon the shape, and partly upon the size of the orifice, and is greater for a bell-shaped approach

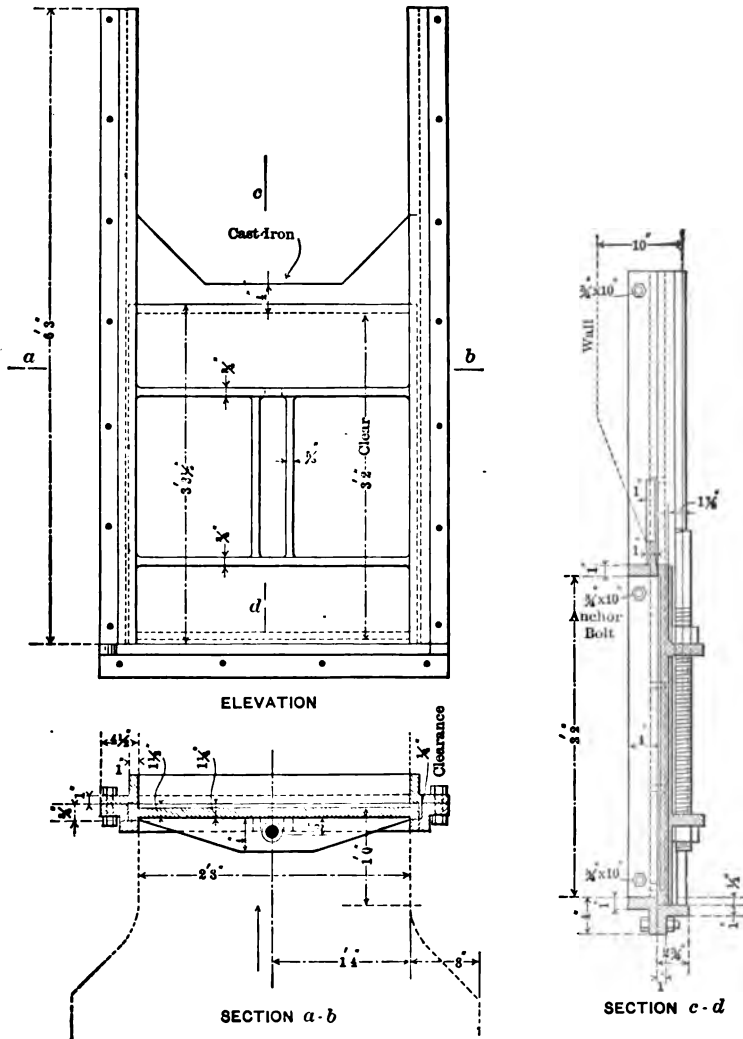

FIG. 109.—Cast-iron Gates for Laterals, Interstate Canal, Nebraska-Wyoming.

than an angular opening. It is usually somewhat less than .8, so that the formula may be written roughly $V = 6\sqrt{h}$.

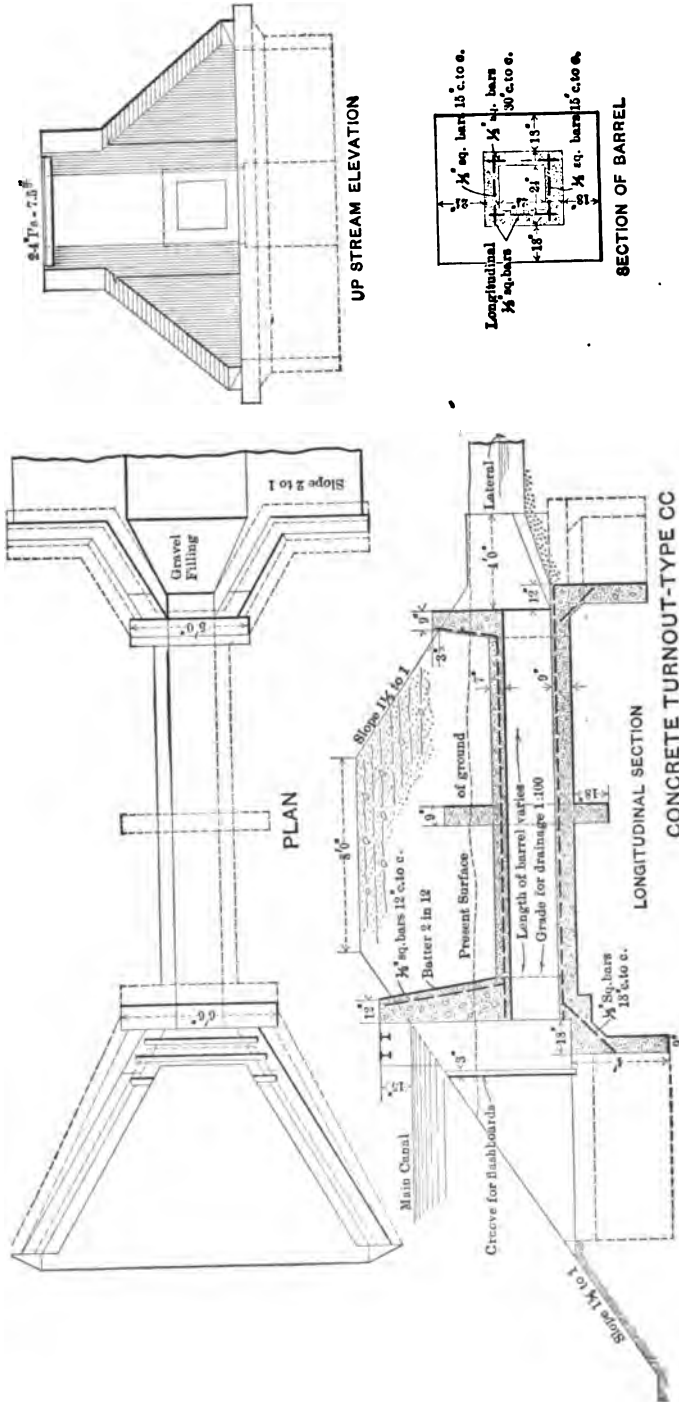

FIG. 110.—Reinforced Concrete Turnout for Lateral.

The capacity of the turnout will of course be the area of its cross-section multiplied by the velocity of the water, or $Q = A6\sqrt{h}$.

5. Canal Spillways.—Any large canal system must for safety be provided with a number of spillways in order to discharge any surplus water it may contain, and avoid overtaxing its capacity. Also to discharge all the water, when it becomes



FIG. 111.—Lateral Headgates North Platte Valley, Nebraska.

necessary to quickly empty the canal in case of a break or a threatened break.

The break of a large canal discharging its great volume of water across the country, may be very disastrous, especially if the canal is on a side hill high above the country threatened, or where the torrent crosses valuable improved lands. Sometimes these conditions are aggravated by treacherous materials in which the canal is built, in which case the need of adequate spillways is greater. This need is also emphasized where the canal receives considerable local drainage into its prism, and in

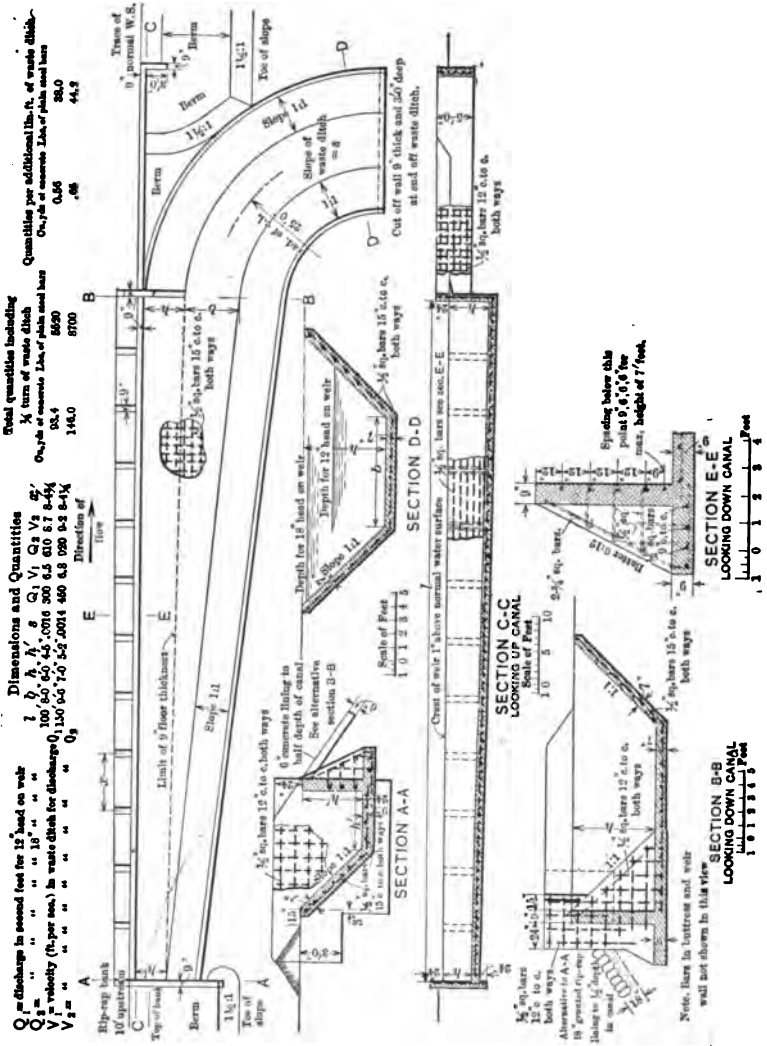

FIG. 113.—Standard Spillway. Length of weir over 100 feet. U. S. R. S.



FIG. 114.—Keno Canal Spillway, Klamath Falls, Oregon.

case of abnormal rains may occasionally have its capacity overtaxed.

A large canal is usually provided with a permanent weir in its lower bank immediately below the headgate, the crest of the weir being placed at the elevation of normal water surface of the canal so as to discharge any water that may enter the canal in excess of its normal capacity. Such a spillway will not discharge any considerable quantity of water until the water stands considerably above its lip, and though the discharge increases with the rise of the water surface, it does not prevent such rise. The longer the weir, the less the rise it permits. Where it is necessary to have a close regulation of the level

the canal or basin controlled by a spillway, this may be secured by the provision of one or more siphons, of the type shown in Fig. 115. The interior lip *l* is located at the level at which it is desired to hold the water level. The intake lip *i*, is located a few inches below the same level. The outlet *o* is located a few feet below the lip as circumstances will permit, and is situated under water, so that air cannot enter there. When the water rises above the level of the lip *l* it overflows

and as it falls, it entrains the air in the water, creating a vacuum, which is filled by water, and this process quickly equalizes the difference of level between the two sides of the spillway, and it is soon discharging. The velocity of flow is reduced by the difference of head due to friction and the velocity of construction. Velocity is determined by the following formulæ:

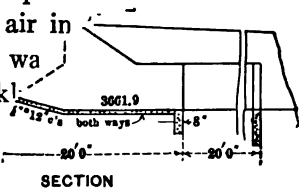

SECTION
way, Fort Shaw Canal, Montana.

following formulæ:

When the water rises above the normal level over this spillway, in a thin sheet, without care must be taken to prevent contraction where it would cause damage.

The discharge controls practically nothing, and affords important canal against overtopping of banks where result.

Use automatic spillways above described permits air to enter the siphon. When the pond *c*, is depressed by the siphon, and this velocity to discharge surplus waters, every large provided with one or more wasteways through

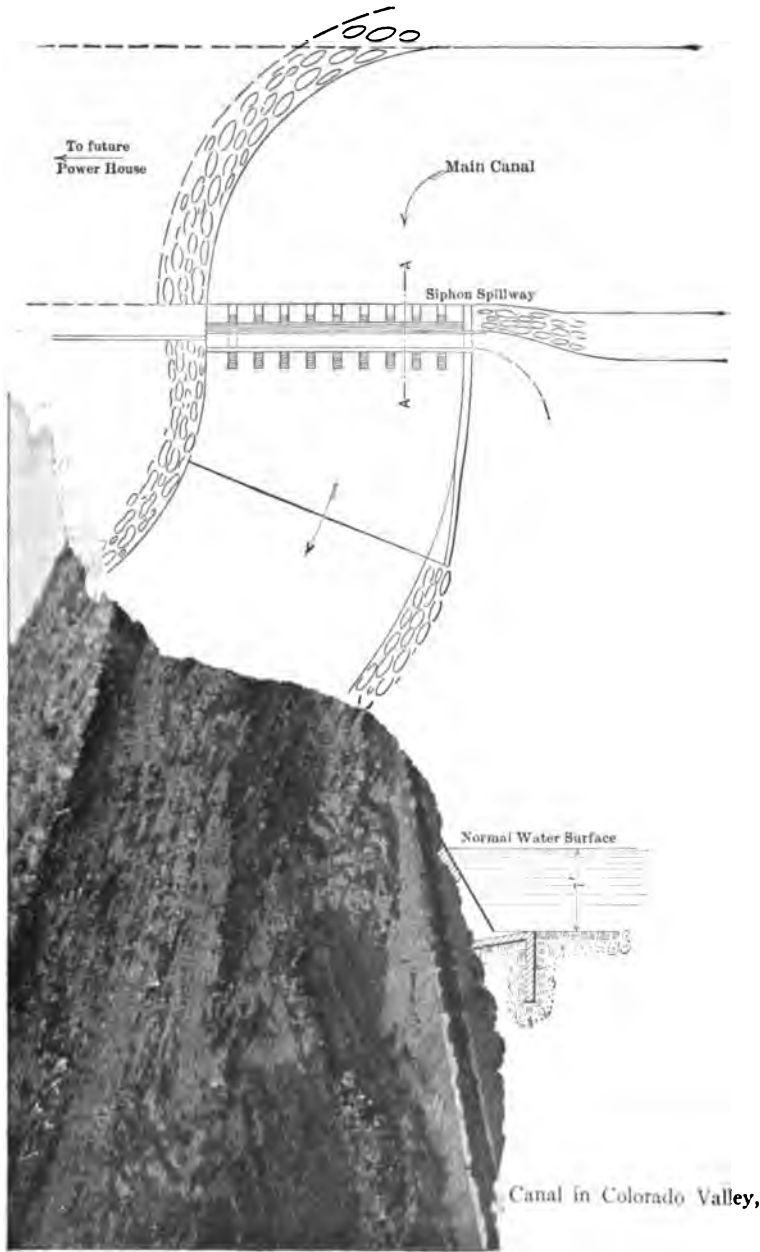

of the intake lip *i*, otherwise the action of the siphon will be stopped by the entrance of air before the pond is drawn down to the level desired. The coefficient of discharge *c* in such a siphon is usually between .6 and .7 when in full operation.

Where a large canal is located in rock or other firm material, or in good soil protected by grass sod on very gentle slope, spillways are often provided by so locating the canal that the water surface of the full canal will be just even with the natural ground level on the downhill side, and omitting any bank for a

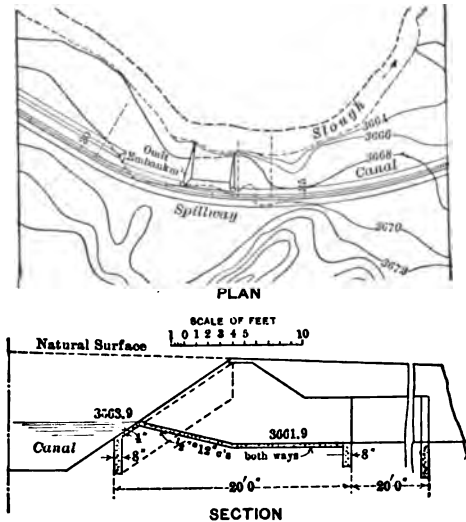

FIG. 116.—Spillway, Fort Shaw Canal, Montana.

considerable distance. When the water rises above the normal level, it flows gently over this spillway, in a thin sheet, without destructive velocity. Care must be taken to prevent concentration of the water where it would cause damage.

Such a spillway costs practically nothing, and affords important protection to the canal against overtopping of banks where breaks would be the result.

In addition to those automatic spillways above described which are designed only to discharge surplus waters, every large canal should be provided with one or more wasteways through

which the canal can be safely and quickly emptied in case of a break. In the absence of such a provision, if the canal should break the water would rush through the break and continue to do so until the canal is emptied, after closing the headgates. This might occupy several hours or even days and cause a large amount of damage, both to the canal itself, and to the farms below which lie in the path of the flood in seeking its way back to the river. Such a spillway is usually called a wasteway. One such wasteway should be located every 10 or 20 miles according to the needs. If natural drains are crossed that can carry safely the full capacity of the canal, these furnish good locations for wasteways, and the necessary structure may be

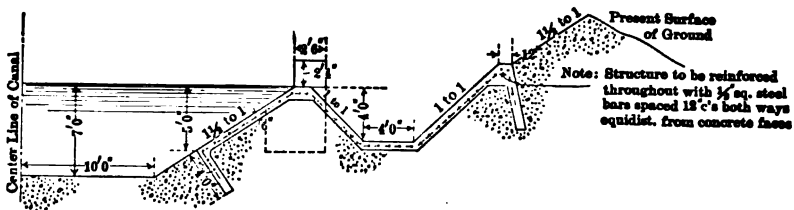

FIG. 117.—Standard Sluiceway, Lower Yellowstone Canal, Montana.

combined with the structure required for crossing the natural drainage channel. Where no such opportunity exists, location should be sought where the distance to the river is short, and it will be necessary to provide a substantial lined channel to the river, to prevent damage to the lands traversed.

At the head of the wasteway, if possible, the bottom of the canal should be depressed several feet below the regular grade of the canal and the sill of the spillway gates should be at the lowest part of the depression. This will give the water in the wasteway a high velocity, and enable it to draw strongly from both directions in the canal, and thus empty it quickly. The depressed section of the canal will also serve to gather gravel, sand or heavy silt that may be traveling on the bottom of the canal, and the wasteway will serve as a means of sluicing such material back to the river, and thus perform a double function. In case the canal is heavily silt-laden, it may be advisable to

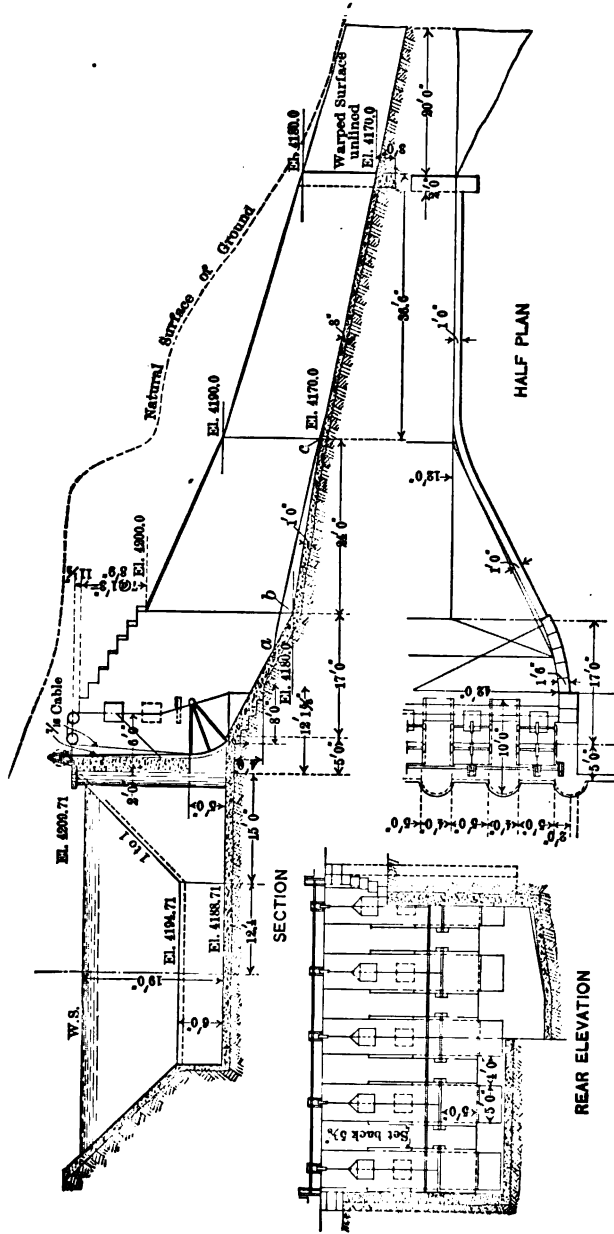

FIG. 118.—Wasteway, Lower Truckee Canal, Nevada.

widen as well as deepen the canal at the head of the wasteway, so as to greatly enlarge the canal section and reduce the velocity of the canal at this point, and thus form a settling basin for silt.

A wasteway located within a short distance below the head of the canal at a point near the river may be so arranged that when opened it will produce a scouring velocity in the canal clear back to the headgate, and be made very effective in ridding the canal of accumulations of gravel, sand and silt. In such cases it is well to provide a set of check gates in the canal just below the wasteway, so that by closing these, the influence of the wasteway may be concentrated upon the scouring of the section above, and in case of a break in the canal below, the check gates may be left open to permit the emptying of that part of the canal also.

The gates of the wasteway should be of some type that can be quickly opened, as they are primarily for emergency use. For this reason it is generally best to provide some form of power for opening them. A small turbine wheel acting under the greatest head available from the canal may be thrown instantly in action by a small valve operated by hand, or by electricity from a distance, and this wheel, generating 10 or 20 horse-power, may be made to open the gates very quickly.

Where the canal is located high on a mountain side so that the great head and steep slope will cause a break to be especially destructive, a series of spillways may be electrically connected with automatic floats, so that if the water suddenly rises or lowers in the canal the floats close the circuit and open the spillway, instantly. A slide from above may obstruct the canal, and cause it to overflow, but if the rising water opens the wasteway, the canal may be relieved before much harm is done. Conversely, if the canal water surface is lowered by an incipient break, this also opens the wasteway, and empties the canal before great damage is caused.

A type of automatic spillway that has been successfully employed on the Tieton Canal in the State of Washington is described as follows:

On the course of the canal where a spillway was desired, a



FIG. 119.—Tieton Main Canal, Lined Section.

pit was built about 4 feet below the grade of the canal. A cast-iron sluiceway 4 feet by 5 feet is operated by a 10-inch vertical turbine located just outside the wasteway pit with its intake at such an elevation that the sluiceway is entirely opened when the receding water falls to the center of the intake opening. The turbine shaft is connected to the gate shaft by a system of gears. To the turbine gate shaft is attached a drum around which a small cable is wound, having attached to its end a suspended weight. When the turbine gate is closed the weight is suspended and holds a projecting pin from the handwheel against the magnet release, which is electrically connected with floats placed at frequent intervals along the canal. Any abnormal change of water surface in the canal makes a connection at the float that causes the magnet to release; this drops the weight, which opens the turbine gate and starts the turbine, which opens the wasteway gates. To close the gate the operation must be started by hand until the water rises in the pit enough to enter the turbine intake, after which the clutch may be thrown in and the gate closed by water power.

6. Checks, Drops, and Chutes.—Where the slope of the country over which a canal passes is greater than the safe grade of the canal, it becomes necessary to provide one or more structures in which the surplus grade can be concentrated, and the canal transferred from a higher to a lower elevation without injury to the canal. Such a structure is called a "drop" and may be either vertical or inclined. In the former, the water falls freely, while an inclined drop is one in which the water is carried down an inclined pipe, channel or chute, protected against erosion by some form of lining.

A *Check* is a bulkhead in a canal designed to hold the water above it at a higher level than it would otherwise stand, so that when the canal is carrying only part of its capacity, water may be taken into a turnout location above the bottom of the canal. It may be desired at all times to maintain the water level above the check at a higher level than below it, in which case the check performs also the function of a drop. Where this is not the case, and the structure is simply a check to be used only when

the canal is running part full and water is being taken into the lateral, it should be so arranged that practically all of the bulk-head can be removed when not needed, so as not to greatly interfere with the flow of water in the canal. During the time that the check is in use, it acts of course, as a drop; i.e., the water stands at a higher level above than below the check, and in falling exerts an amount of mechanical energy, depending upon the quantity of water and the amount of the fall. Precautions must be taken to prevent the destructive erosion of the earthen sides and bottom of the canal just below the check.

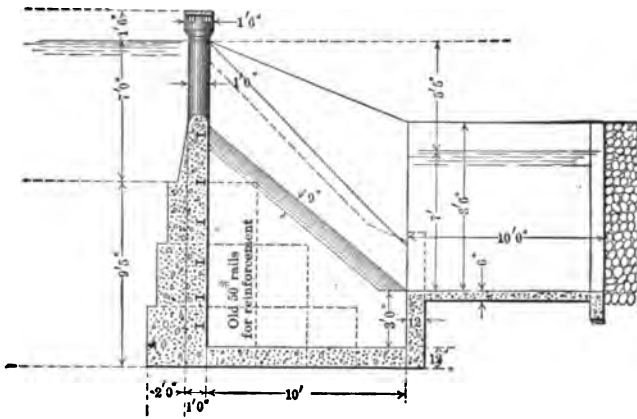

FIG. 120.—Concrete Drop with Water Cushion, Truckee-Carson Canal, Nevada.

The necessity of providing drops under various conditions is a matter of judgment based upon experience. It involves a knowledge of the erosive power of the quantity of water to be handled at the velocity to be expected, and the capacity to resist erosion of the ground over which the water will pass. Some of these elements are variable and others may not be accurately predicted. It is therefore unprofitable to attempt any exact rules or fine distinctions. Some of the earlier irrigation works were built without any special provisions for excess grade, and although erosion was certain, the rule seemed to be "let it cut." These have in some cases resulted in gullies, which have done no great harm. On the other hand, some

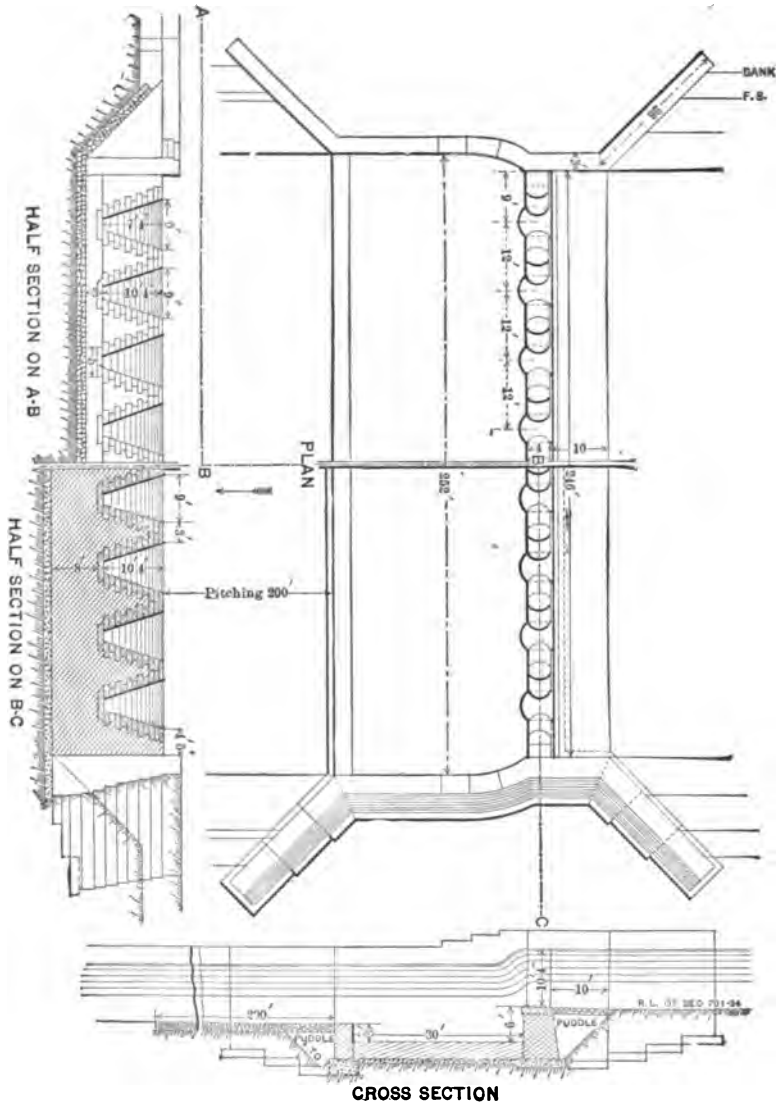

FIG. 121.—Notch Drop, Chenab Canal, India.

engineers carry to an extreme the theory that the theoretical slopes and velocities must be exactly secured regardless of cost. The true test of the problem is the inquiry "What will happen if no provision is made?" If the ground traversed is a loam or sand to a great depth, excess velocities will cause the erosion

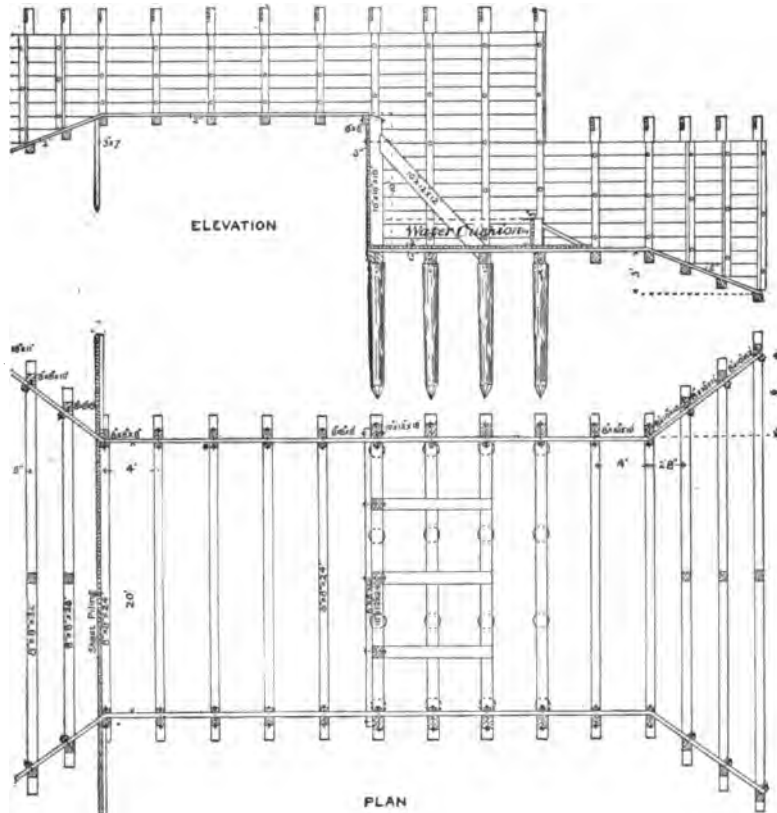

FIG. 122.—Cross-section of Drop, Bear River Canal.

of deep gullies, and the deposit of the eroded material at some point lower down. Even when the channel is straight, slight obstructions or inequalities of material will cause a tendency to meander, and to undermine banks on the outside of curves. If this proceeds it may destroy good land, and load the stream with material to be deposited further down to the detriment

of other property; it may become necessary to provide expensive protection to the banks, and this expense and the damage caused may exceed the cost of the drops that should have been provided in the first place, and may ultimately still be necessary.

On the other hand, cases occur where the alinement of the canal is straight, and where rock, shale, hardpan or other

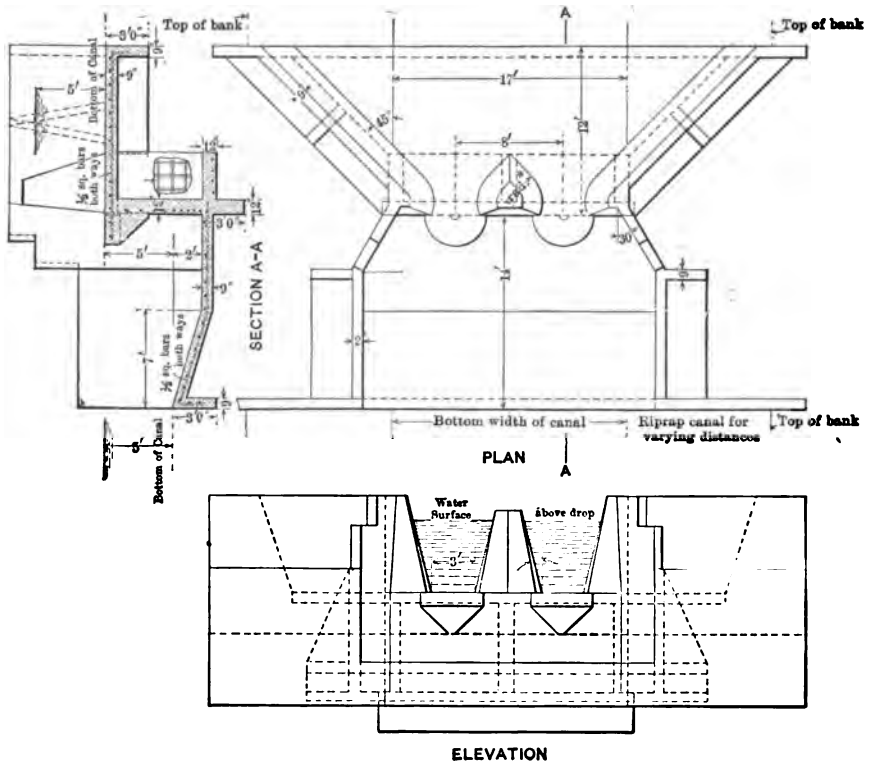

FIG. 123.—Notch Drop, Interstate Canal, Nebraska-Wyoming.

indurated material occurs a short distance below the surface, that will resist erosion, and may be utilized to save expense in the provision of structures and their subsequent maintenance. The hard material may be irregular in its occurrence and quality, and when it is reached by the water, erosion is checked, and a steeper grade is soon established through the hard material

which becomes permanent. In this way the surplus grade is taken up, and with some bank protection, stability is secured.

Where the country has considerable slope it may be necessary to provide hundreds of drops in the lateral system, and it thus becomes important to decide on the most effective and economical design as a standard for each grade, character of soil and quantity of water. Where the slope is considerable and the soil sandy, careful consideration should be given to lining the canal with concrete to prevent erosion, instead of the construction of drops. The high velocities thus secured will

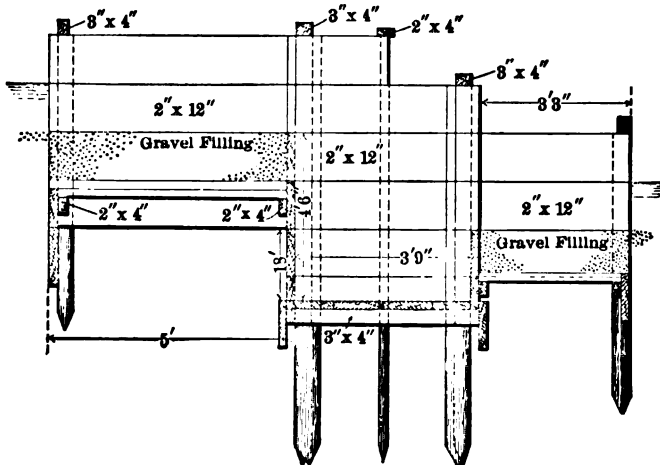
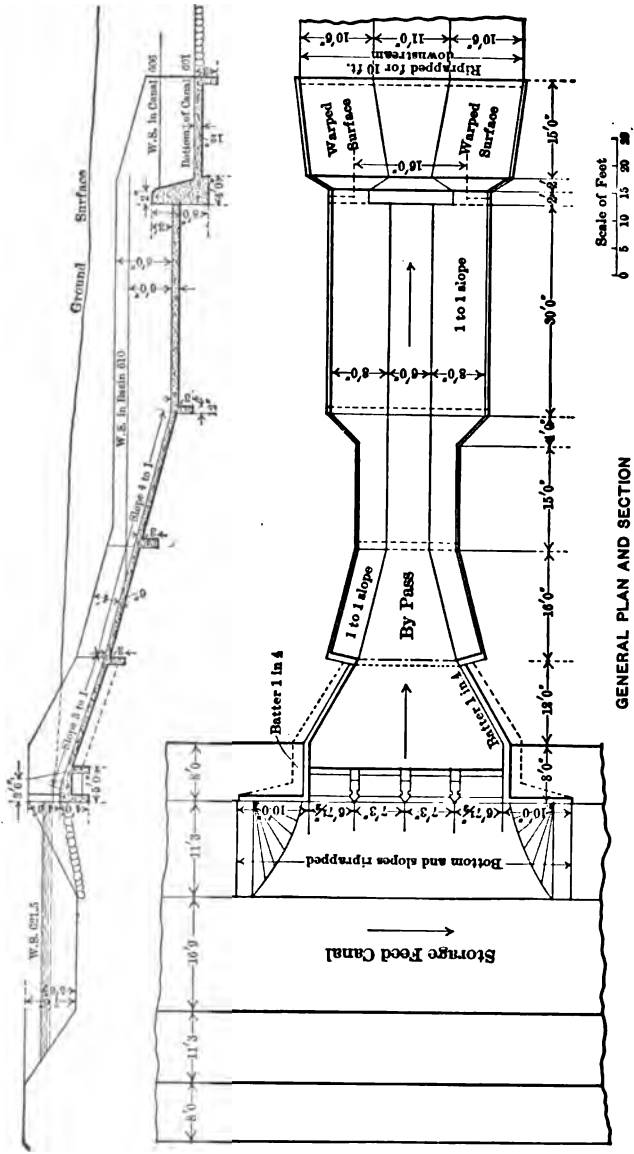

FIG. 124.—Timber Drop, Lower Yellowstone Laterals, Montana.

permit reduction of the cross-section of the canal and thus save in excavation, besides eliminating the cost of the drops; and though the lined channel may be more expensive, it may still be justified on account of the saving of water and in maintenance cost, both of which are important.

A cheap and efficient drop on a small lateral is formed by excavating the channel for the necessary distance on a grade of three or four to one, lining it with concrete, and providing a depressed basin at the foot of the slope to receive and check the rushing water. The lower side of this basin should be vertical to form an effective check to the water. A small cutoff



GENERAL PLAN AND SECTION
 Fig. 125.—By-pass Feeder from Upper to Lower Canal, Umatilla Project, Oregon.

wall should be provided at the upper edge of the lining where the water reaches it, to prevent under-cutting. Such simple drops have been successfully used in light soils by the U. S. Reclamation Service, and are very cheap, requiring very little forming for the stilling basin, and none at all for the lining.

For large volumes of water more elaborate structures are required. These are sometimes of wood, but are more permanent and reliable when built of concrete.



FIG. 126.—Cylinder Drop on Franklin Canal, Rio Grande Valley, Texas.

The notched drop, introduced in India and employed to some extent in this country, has the crest of the fall surmounted by a weir with a series of notches with their bases level with the canal bed, and the top of the weir at or above the full supply level. The notches are designed wider at top than at base, so as to discharge at any given level, the same amount of water that the canal carries at that level at normal velocity, and thus prevent undue fluctuation of velocity as the volume of water

varies. Below each notch is provided a semicircular horizontal lip or bracket to receive the falling water and spread it out into a semicircular sheet. This has a tendency to diminish the action of the water on the banks below.

The U. S. Reclamation Service has used a novel form of drop in the Rio Grande Valley, consisting of a concrete structure



FIG. 127.—Series of Concrete Drops on South Canal, Uncompahgre Valley, Colorado.

in which the water is controlled by balanced cylinder gates which can be adjusted to such opening as will produce the proper velocity to prevent scour and deposit of silt at all stages of canal flow. See Fig. 126.

7. Protection Against Erosion.—The tendency to erosion arises from three main causes:

1. The impact of the water on the bottom of the canal as it falls from the higher to lower level. This usually requires some sort of paving.

2. The increased velocity generated by the surplus fall,

which if not somehow checked will persist for some distance down the canal and erode its banks. This may be counteracted by providing a stilling pool at the foot of the drop with depressed bottom and larger section than the regular prism of the stream, in which the energy is dissipated in surges and eddies, and from which the water flows away at normal velocity.

3. The waves produced by the commotion of the falling water, and which generally persist for some distance down the



FIG. 128.—Concrete Chute and Stilling Basin, Boise Valley, Idaho.

canal in spite of elaborate control of the velocity of the water. This generally requires paving or other protection of the bank for 30 to 50 feet below the drop, or in very light soil, a still greater distance. This protection may be a lining of concrete or of grouted rip-rap, or other form of paving. Open rip-rap without mortar soon fails in light soils by the washing out of soil through the cracks. In many cases sage brush held in place by stakes and wire has been successfully used.

The amount and character of protection necessary depends upon the quantity of water falling, the amount of the fall, and the character of the material in which the drop occurs. Unless the latter is rock or very firm gravel or hardpan, some paving or other artificial protection is always necessary. The size and depth of the stilling pool has been much discussed, but engineers are not agreed upon any general rule to govern these points. The best practice is to provide a pool depressed from 1 to 3 feet below the bottom of the canal below the drop, and having a cross-section from 50 per cent greater than the normal water prism, to three times as great, varying between these limits according to the three factors above mentioned, namely, the height of fall, the quantity of water, and the character of soil in which the drop occurs.

In some cases it is necessary to carry the water down a long slope requiring either a series of drops or a long chute, consisting of a lined channel with a stilling basin at the bottom. The choice between these types will depend mainly upon the cost, but if properly built the maintenance of a chute is generally less than that of the vertical drops that would take its place.

The inclined drop or chute consists essentially of an inlet structure, a trough to conduct the water down the hill, and a pool at the bottom to receive the water and destroy its accumulated energy. The transition from the canal to the drop must be provided with numerous and deep cutoff walls for the wing-walls, floor and sides, carefully puddled in, to prevent percolation of water along the structure. Where the water enters the trough control gates should be provided. A short distance below, the trough converges to a narrow channel to correspond to the increased velocity, which may reach 40 or 50 feet per second. Cutoff walls must be provided at frequent intervals under the trough, and great precautions must be taken to prevent erosion under the trough, either by rainfall or by leakage from the structure, as the steep hillside will favor rapid and destructive erosion if an opportunity occurs.

Trouble was encountered on the Boise Project of the Reclamation Service with the spilling of water over the sides of the stilling

basins at the end of concrete chutes and investigation was made to find a remedy.

The cause of the trouble apparently was that in designing the structure no allowance was made for the great amount of air carried into these basins with the water. Eleven structures were investigated and the remedy generally adopted was to raise the sides and cover the basin. The investigations seem to indicate that in designing stilling pools, consideration should be given to the increased volume of the discharge due to mixture of air with water. For velocities from 15 to 40 feet per second, the increased bulk is estimated to be from 15 to 35 per cent.

The pool or check basin at the bottom of the chute must be of massive construction to receive the shock of the rushing waters, and stop it without injury. An excellent form for such a check basin is one on the Sulphur Creek wasteway on the Yakima Project in Washington, which is designed to receive and stop a stream of 500 cubic feet per second flowing at a velocity of about 25 feet per second. This structure is of concrete, rectangular in plan 14 by 18 feet, by 18 feet high. The water comes in at one end of the box near the top, and escapes through two rectangular openings in the sides, each $12\frac{1}{2}$ by 4 feet. The water plunges into the basin and dissipates its energy by impact on the water already there, and is turned practically through 3 right angles before it can escape. This structure accomplishes its object satisfactorily, as the water flows quietly down the unlined canal without erosion.

Deep gullies are unsightly and may be dangerous if very deep with precipitous banks, and it requires important saving of expense to justify the omission of sufficient drops to consume the excess grade.

Where the drop can be located in rock it may be unnecessary to provide any special protection to the bottom or sides.

8. Drainage Crossings.—Where a canal location intercepts a natural drainage line or torrent, as it is sometimes called, it is necessary to decide what disposition to make of the drainage water that may be expected, in order that it may not damage

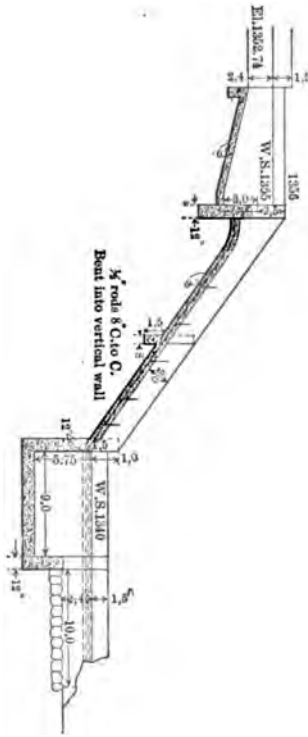
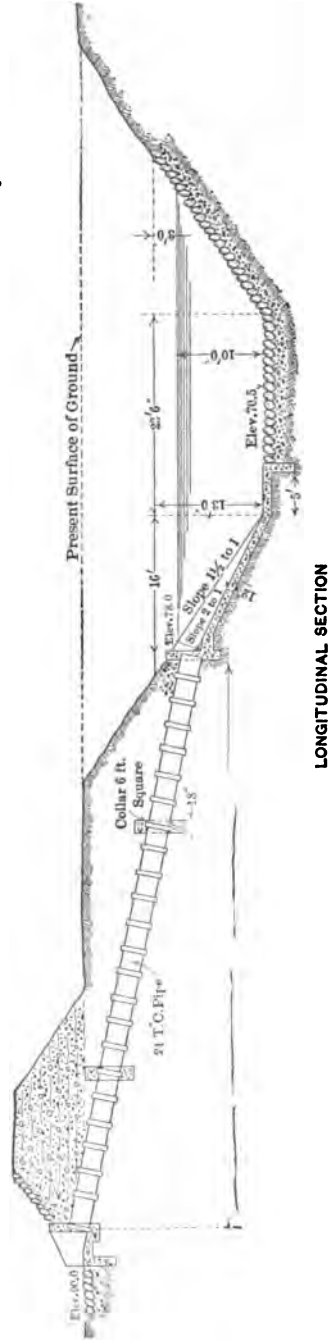

FIG. 129.—Reinforced Concrete Chute Okanogan Project, Washington.



LONGITUDINAL SECTION

FIG. 130.—Pipe Inlet, Reno Coulee, Lower Yellowstone Canal, Montana.

the canal. There are four possible methods of dealing with such problems, each of which is suitable to a certain class of cases.

1. The drainage may be received into the canal, in cases where it is small in amount and the canal is large.

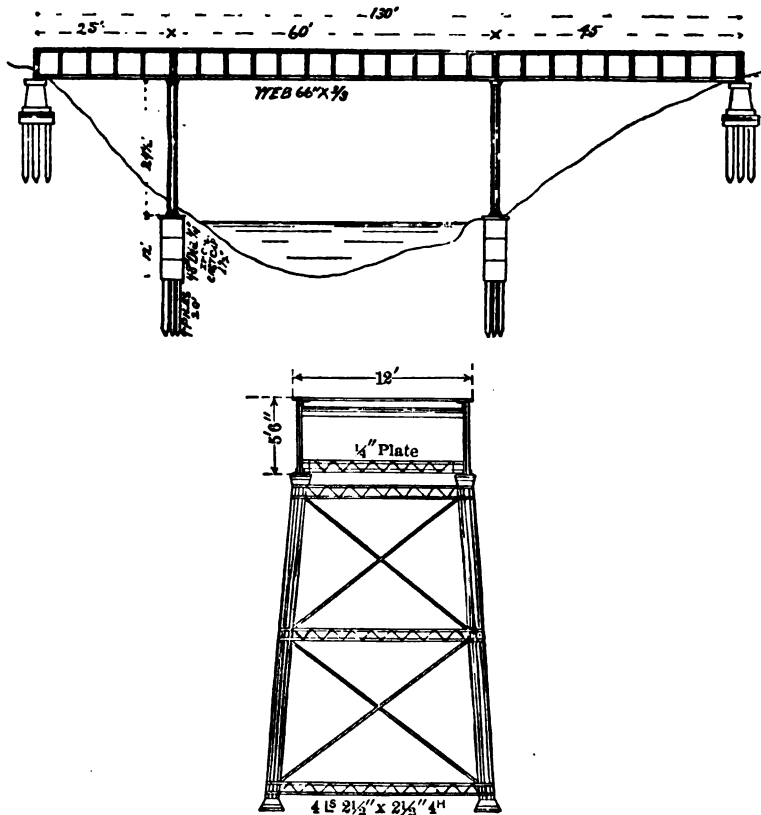

FIG. 131.—Elevation and Cross-section of Iron Flume on Corinne Branch, Bear River Canal, Utah.

2. The canal may be carried over the drainage channel in a flume, or upon an embankment provided with a culvert through which the drain water passes under the canal.

3. The canal may be carried under the ravine in an inverted siphon or pressure pipe, or the drainage may be conducted over the canal in a broad flume called a superpassage.

4. The drainage may be intercepted by a diversion dam and canal and conducted along and parallel to the canal, to a point where sufficient drainage is concentrated to justify the provision of one of the structures above mentioned.

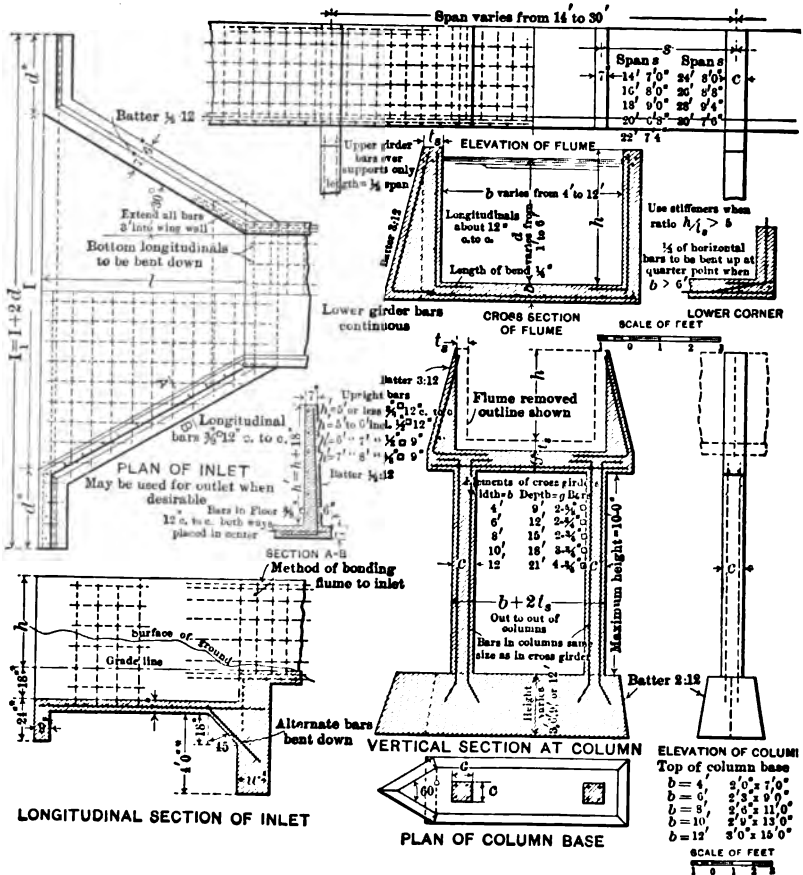

FIG. 132.—Standard Reinforced Concrete Flume, Reclamation Service.

Wherever a large canal is built on ground sufficiently sloping so that no bank is required on the uphill side, some rain water will inevitably flow into the canal from the surface of the ground. From the admission of such rain water, it is but a step to the admission of small drainage channels which seldom carry water,

and carry but little at any time. Where it is necessary to admit considerable quantities of surface water to the canal, its safety may be protected by providing in the vicinity a spillway of one of the types described in Art. 5.

Even when the water brought in may be thus taken care of, the admission of drainage to the canal is often objectionable because such drainage usually carries sediment and detritus which may be expensive to remove. Care must be taken in all cases to protect the side of the canal where drainage enters, against the erosion of gullies which destroy the symmetry of the canal, and fill it with detritus. This protection may consist of a short concrete retaining wall, over which the drain water falls into the canal. The provision of a combined wasteway and settling basin with bottom opening for sluicing sediment, may justify the admission to the canal of much drainage in the vicinity otherwise inadmissible.

Cases sometimes occur where the collection of drainage water is one of the important functions of a canal, the object being to increase the water supply above that otherwise available. The water supply thus obtained is usually so irregular that a storage reservoir is necessary to utilize the full benefit of such supplies, and it thus becomes especially important to provide for ridding the canal of sediment brought in with the drainage to avoid filling the reservoir with solid matter and destroying its useful-

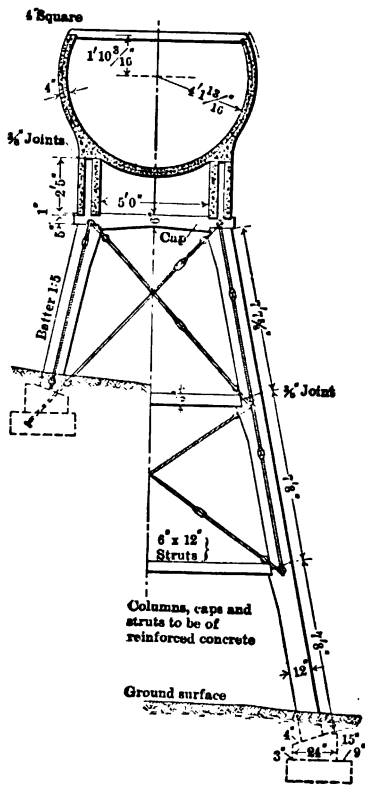

FIG. 133.—Circular Reinforced Concrete Flume and Trestle, Tieton Canal, Washington.

ness. This may best be done by means of settling basins with bottom opening for sluicing purposes as described in Art. 5.



FIG. 134.—Headworks of Cavour Canal, Po River, Italy.



FIG. 135.—Brick Aqueduct, Carrying Cavour Canal, Po Valley, Italy.

In all cases the drainage to be admitted should be carefully estimated, especially as to its probable maximum volume, and provision made for such maximum with a considerable margin

of safety. The lower bank of the canal must be of ample height and thickness, and must be rigidly inspected for the works of burrowing animals, so that a sudden rise in the water level shall not disclose a hole to lead water through the bank and cause disaster.

9. Flumes.—Where the drainage line intercepted is in a ravine or canyon of moderate depth, but well below the grade of the canal, the latter may be carried across in a flume. This may best be of concrete, especially if very large, but on account of the high cost of the concrete structure, flumes are more often built of steel, upon wooden trestles, or entirely of wood. These are more expensive in maintenance, and will require renewal of the wooden parts in from 10 to 20 years, even when well cared for. In any case the trestle bents should be founded upon concrete or rock, and contact between wood and earth at any point entirely prevented, to avoid quick decay. The most common form for wooden flumes is a rectangular box, and should provide for a water depth of about half the width, as this gives the maximum value of r in the formula and consequently the maximum velocity and capacity. For the same reason, the inside of the flume must be made as smooth as possible. The lumber should be planed, and placed longitudinally, so as to have the minimum number of joints across the course of the water, and every care taken to avoid friction or obstruction to the flow.

The flume must be so constructed that it is firmly held against the tendency to spread which will develop when filled with water. This is accomplished by means of the sills at the bottom, and the sides may be held at top by means of braces across the top, either of timber or of heavy wire, or the sides may be braced by inclined studs placed upon extensions of the sills. A standard form of box flume is shown in the drawing, Fig. 138.

The lumber forming the box of the flume must be carefully milled so as to fit well, and some measures must be provided to make the cracks water-tight. This is sometimes secured by milling a small bead on one or both edges of the lumber which can by reasonable pressure be made to form a tight seam. Very

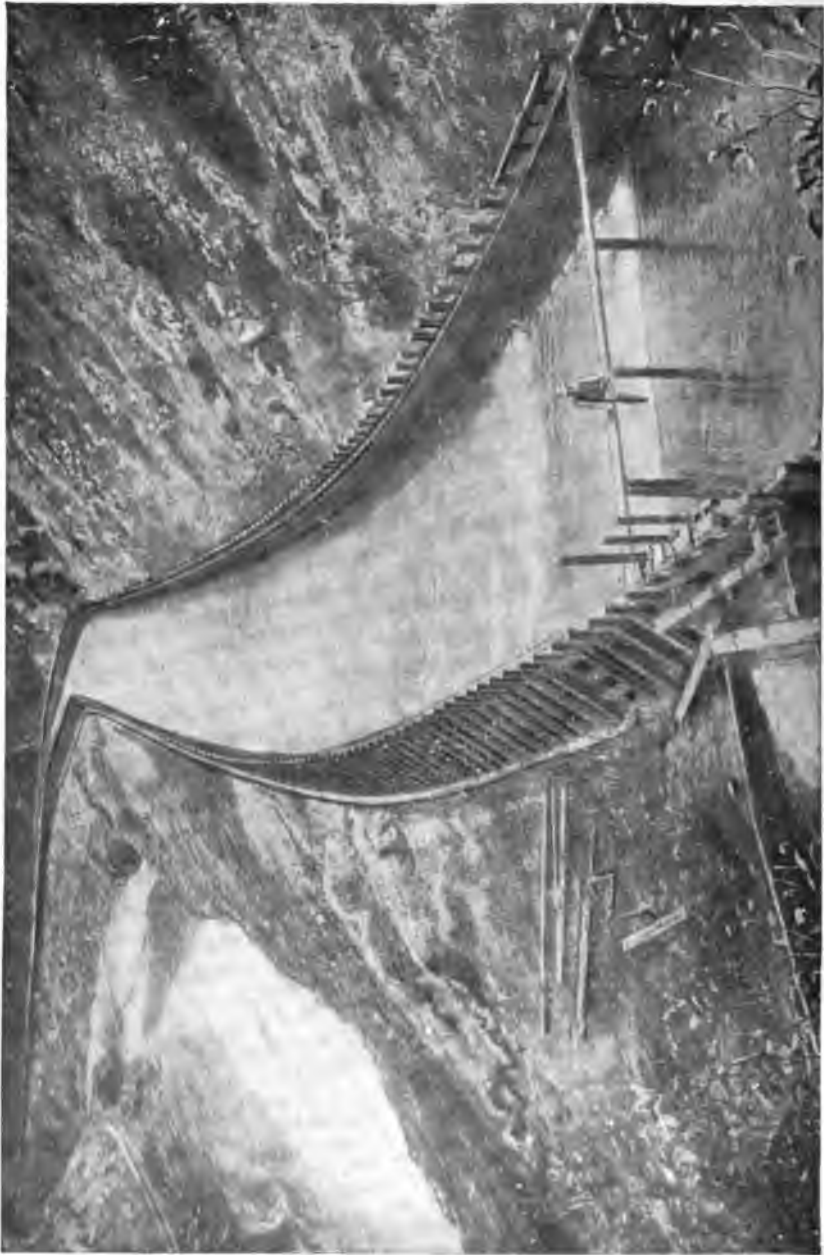

FIG. 136.—Bench Flume, Highline Canal, Colorado. Escape in Foreground.

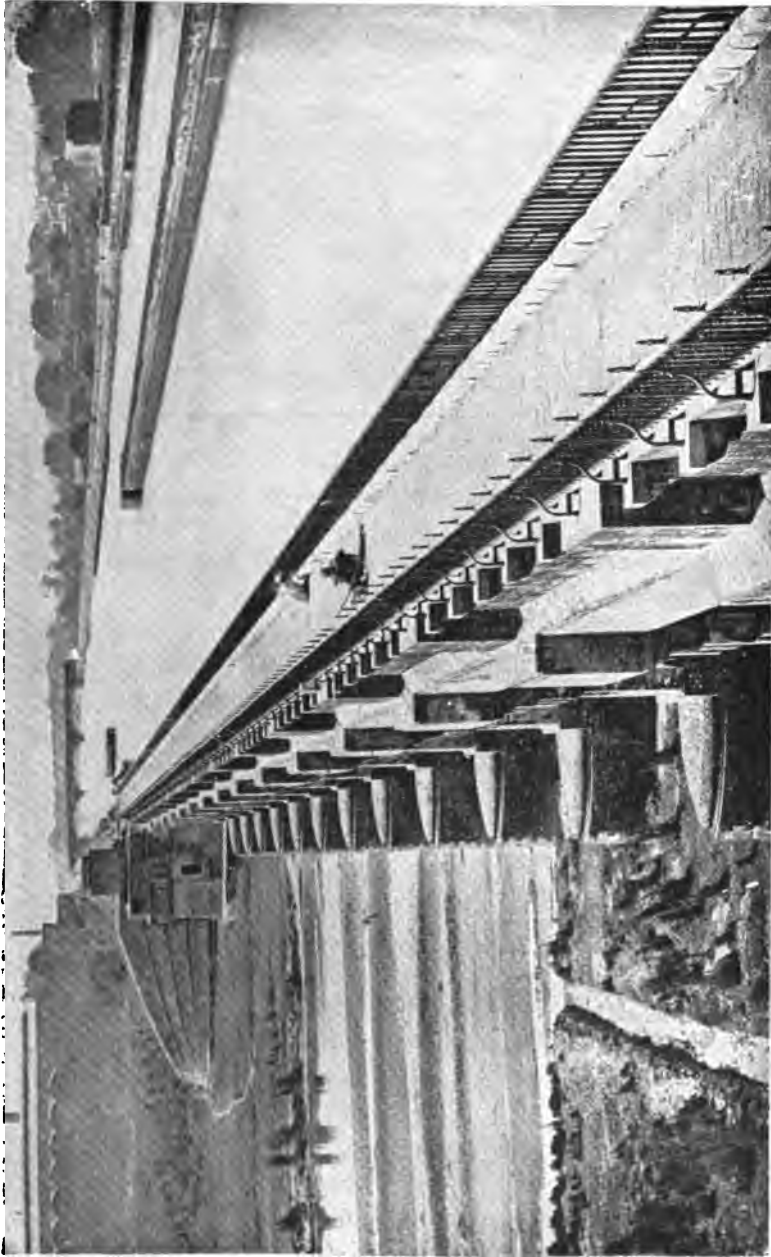

FIG. 137.—View of Solani Aqueduct, Ganges Canal, India.

effective sealing may be secured by caulking with oakum. To facilitate the caulking process the lumber may be slightly beveled on one edge, thus leaving a small opening on the inside of the crack for the insertion of the oakum. The caulking may

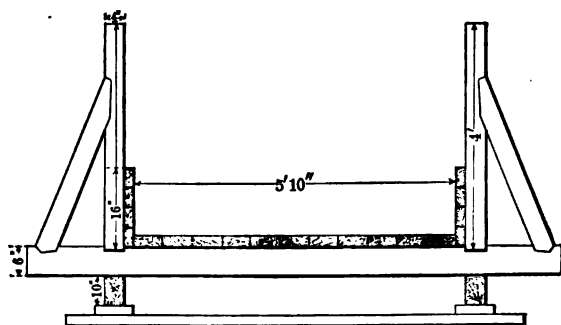

FIG. 138.—Cross-section of San Diego Flume, California.

require repetition every spring for two or three years after which longer intervals may be found permissible.

Another means of closing the seams of the box flume is by inserting asphalt or coal tar, and holding it in place by means

of a batten along the seam, or a similar end may be secured by milling the lumber so as to admit and hold the sealing material.

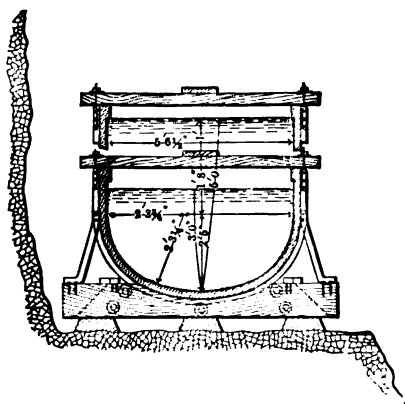

FIG. 139.—Cross-section of Stave and Binder Flume, Santa Ana Canal, California.

An objection to the use of battens on the bottom of the flume is that if fastened to both planks forming the seam, the shrinkage that is likely to follow when water is turned out of the flume will split the batten and cause leaks

with no convenient means of repair except by replacing the batten.

Coal tar or asphalt should in use be applied hot and preferably in warm weather, so that all cavities may be penetrated before the asphalt solidifies.

Another serviceable form of wooden flume is the half circle, formed of wooden staves supported by iron or steel rods, the ends of which are held by stringers. These rods are fastened by nuts which, when screwed up cinch the staves and close all cracks tightly. This means can be used each year to take up the shrinkage of staves and keep the flume tight. The necessity

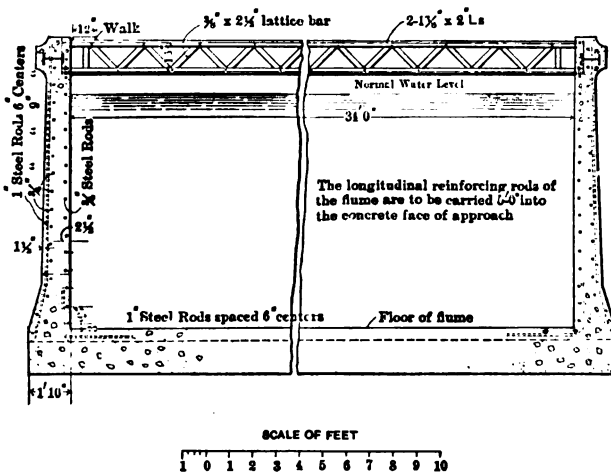

FIG. 140.—Section through Reinforced Concrete Aqueduct, Interstate Canal, Nebraska-Wyoming.

of caulking may thus be avoided, if the staves are carefully milled, and this constitutes an important advantage of the circular over the rectangular form of flume. The screw threads must be kept well greased to prevent rust, and keep them available for the annual cinching. When properly built and maintained such a flume is generally more satisfactory than the box flume.

Steel Flumes.—Closely similar to the circular wooden flume is the steel flume supported on wooden trestles. The metal takes the form of the half circle, and is supported by iron rods. The sheets of steel are purchased in standard sizes, the largest

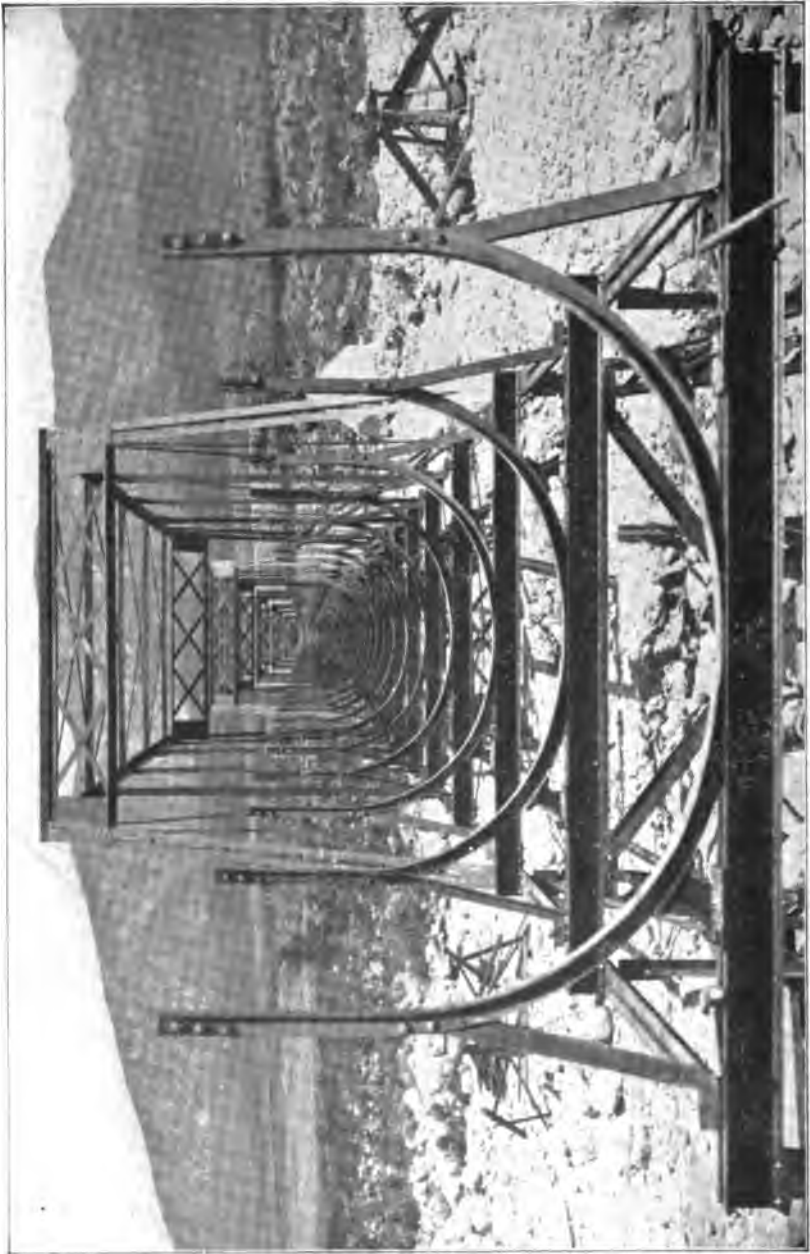

FIG. 141.—Mill Creek Flume and Steel Bridge, Santa Ana Canal, California.

obtainable being usually 10 feet in length. A half-circular flume formed of such sheets has an area of 31.76 square feet, or leaving 1 foot freeboard, about 25 square feet of waterway. If a capacity greater than this is desired, it becomes necessary to duplicate the flume, or adopt some other type. The transverse joints have been formed in various ways more or less efficient, the most essential requirement being that they present the least possible obstruction to the flow of water, and hence be flush with the surface of the flume.

If the flume is over 50 feet in length, it should be provided with joints that will absorb expansion and contraction due to temperature changes.

If the flume can be conveniently built in cold weather, while the metal is contracted, fewer contraction joints will be required than if placed in summer.

The metal sheets should be galvanized and after construction the waterway should be treated with two coats of tar paint, the first of water-gas tar and the second of coal tar.

If the flume carries sand or gravel this will quickly wear through any protective coating, such as tar or zinc, and leave the iron exposed to rust, so that it is very important to eliminate sand or gravel if present. This may be done by providing a settling basin and sluice gate at the upper end of the flume, either in the flume itself or above its entrance. With such a provision, and careful attention, a metal waterway may be expected to last much longer than a wooden one.

All parts of the flume should be amply heavy, so that its load will not cause notable deflection and develop leaks. It is of prime importance that the lumber be well seasoned so that it will not seriously warp and shrink after construction. The life of the wood may be somewhat increased by some form of treatment by antiseptic preparations. The cheapest of these is a bath in hot crude petroleum. This should be sufficiently prolonged so as to permit the escape of all confined air, and its replacement with oil.

Treatment with creosote or zinc oxide as practiced with railroad ties prolongs the life of the wood, but where it is kept

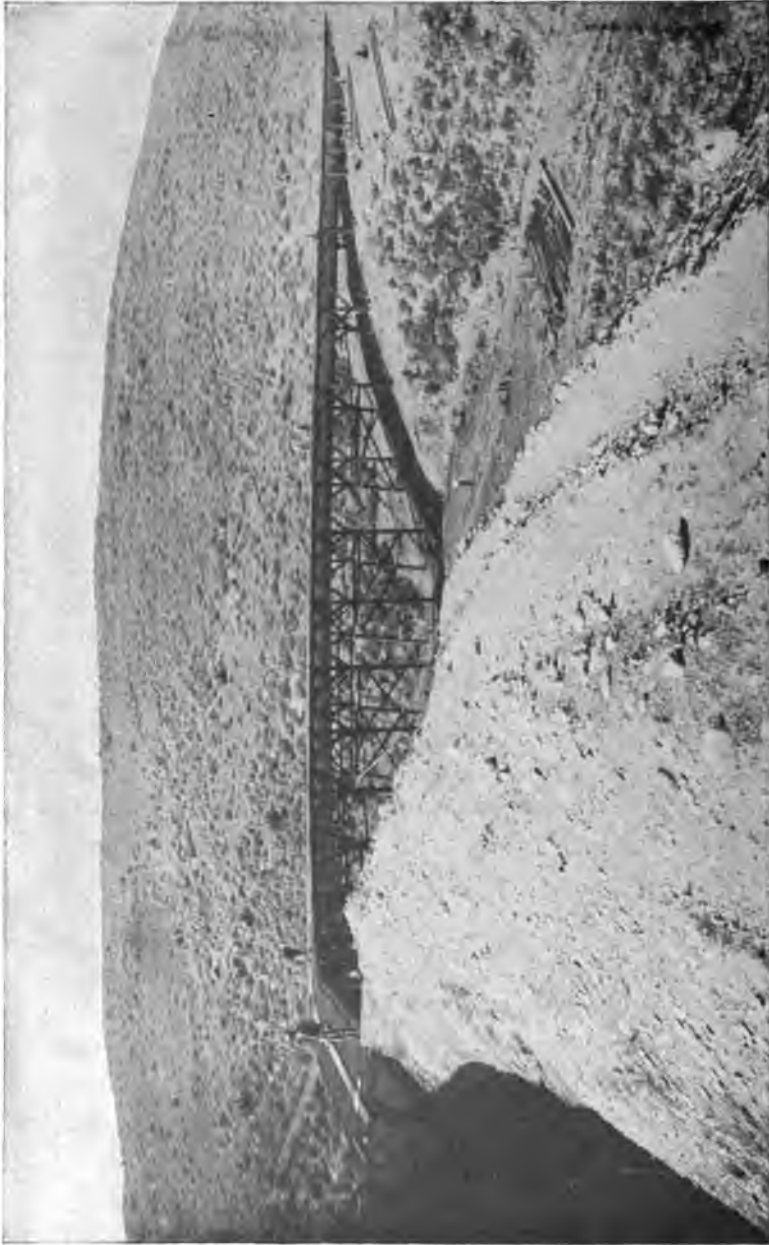

FIG. 142.—Steel Flume, Tieton Distribution System, Yakima Valley, Washington.



FIG. 143.—Steel Flume, Crossing Eight Mile Creek, Boise Valley, Idaho.

away from earth, the benefits derived from treatment are hardly commensurate with its cost. Some benefit may be derived by treating the structure after completion with a wash of any of the common preparations from petroleum or coal tar; or of the more durable paints. Painting lumber not seasoned does more harm than good.

Care should be taken to prevent contact with earth, which hastens decay whenever it occurs. Footings and mud sills may generally be built of concrete.

10. Behavior of Various Metals in Presence of Alkali.—Certain preparations of iron and steel have shown resistance to the

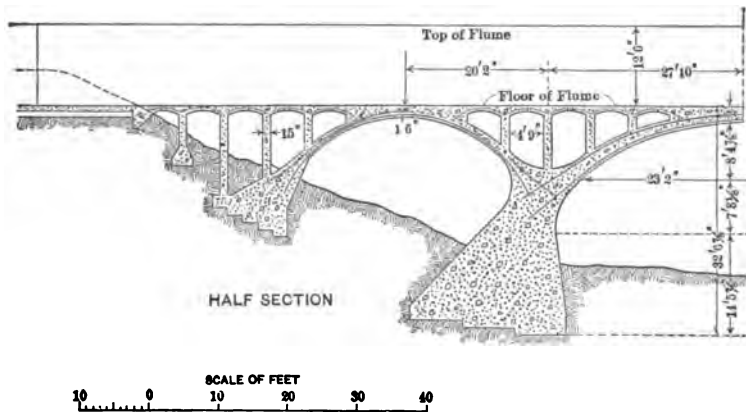

FIG. 144.—Half Longitudinal Section, Reinforced Concrete Aqueduct, Interstate Canal, Nebraska-Wyoming.

attacks of acids as shown by standard tests, but western waters are often alkaline, and resistance to alkali is a different problem. The U. S. Reclamation Service has made a series of experiments to test the virtues of various metals in the presence of alkali such as occurs in many western soils.

The results of these tests as reported by the project managers on three different projects are shown in the following table. All the sheets were planted in alkaline mud, the tests samples being side by side, under conditions as similar as possible. The results speak for themselves:

TABLE XXXI.—METAL SHEETS IN ALKALINE SOILS

Material.	Weight. Ounces.	Length of Test. Years.	Loss. Ounces.	Loss. Per Cent.	Project.
Toncan metal, galvanized . . .	81.75	4	1.00	1.36	Sun River
Ingot iron, galvanized.	88.0	4	1.00	1.14	"
Mild steel, galvanized.	79.50	4	1.00	1.26	"
Toncan metal, ungalvanized.	73.75	4	5.50	7.46	"
Ingot iron, ungalvanized. . . .	78.50	2	2.25	2.87	"
Mild steel, ungalvanized. . . .	75.50	4	4.50	5.96	"
Toncan metal, galvanized. . . .	81.00	2½	.50	.60	Uncompahgre
Ingot iron, galvanized.	89.00	2½	1.00	1.10	"
Mild steel, galvanized.	81.00	2½	1.00	1.20	"
Toncan metal, ungalvanized.	73.50	2½	4.50	6.10	"
Ingot iron, ungalvanized. . . .	81.50	2½	4.50	5.50	"
Mild steel, ungalvanized. . . .	76.00	2½	3.00	4.00	"
Toncan metal, galvanized. . . .	82.50	2½	2.50	3.03	Belle Fourche
Ingot iron, galvanized.	91.00	2½	2.50	2.75	"
Mild steel, galvanized.	81.00	2½	1.20	1.48	"
Toncan metal, ungalvanized.	78.5	2½	5.10	6.50	"
Ingot iron, ungalvanized. . . .	83.5	2½	4.70	5.63	"
Mild steel, ungalvanized. . . .	76.0	2½	2.20	2.90	"

The most striking result brought out by these tests is the immense advantage of galvanized sheets over those of plain metal. It is also made clear that none of the different special preparations tested have any great or uniform advantage over any others.

Where the cost is not too great, flumes should be constructed of concrete, as this will generally form a structure of permanent character if properly built. If the waterway to be crossed is large and the canal also large, such a flume becomes a very heavy structure, and must be very solidly founded to prevent settlement and failure. The most desirable foundation of course is rock, although indurated sand, clay, shale or gravel may be depended upon if the foundation is spread enough to prevent dangerous unit stresses. A foundation of shale sometimes contains seams of soluble salts, which unless well protected, may later dissolve and cause trouble.

In several localities where the surface is underlain by shale, the structures founded thereon, and even the lining of canals

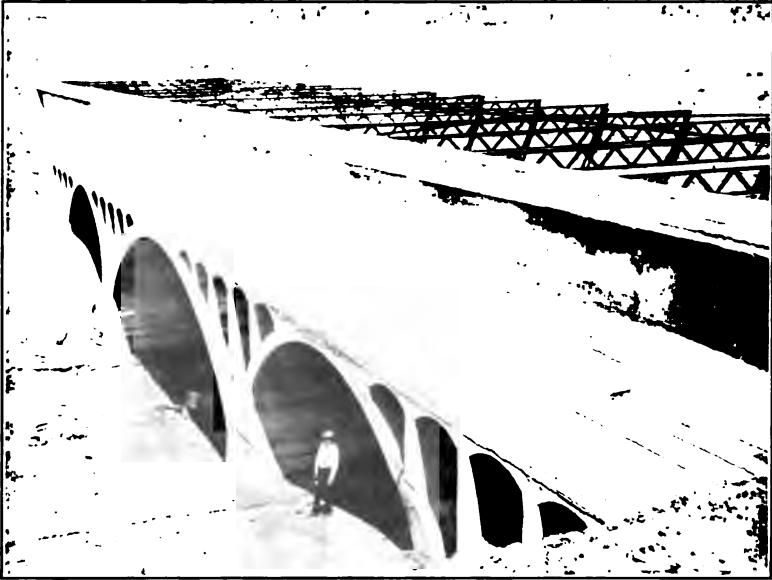

FIG. 145.—Reinforced Concrete Aqueduct, Spring Canyon, Interstate Canal, Nebraska-Wyoming.

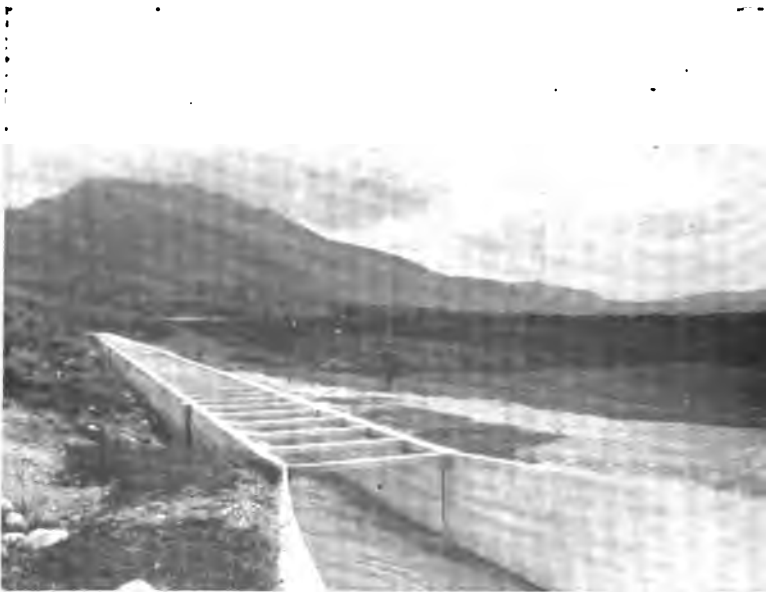

FIG. 146.—Concrete Flume, Spanish Fork Valley, Utah, showing Warped Transition from Canal to Flume.

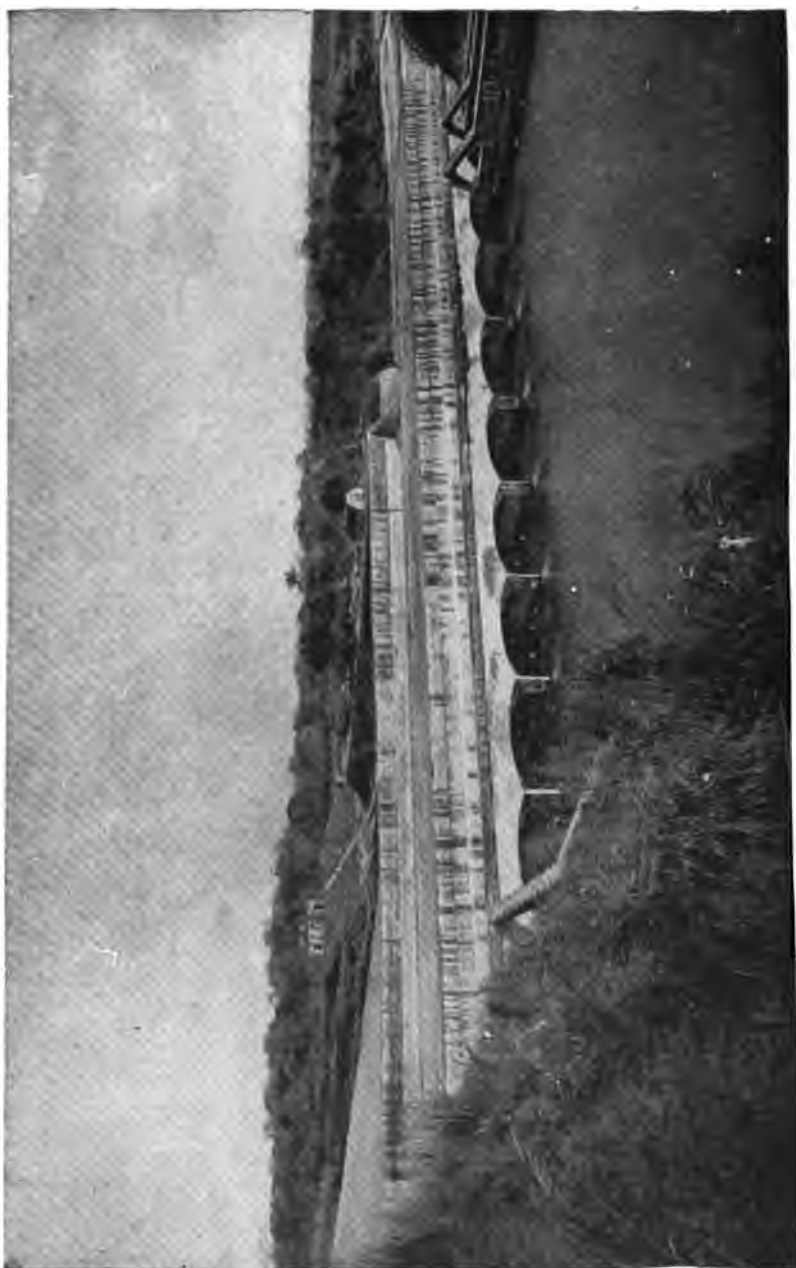

FIG. 147.—View of Ranipur Superpassage, Ganges Canal, India.



FIG. 148.—Continuous Wood-Stave Pressure Pipe, Idaho Irrigation Company's Canal.

have settled and cracks have formed, causing leakage and other annoyance. This seems to be due to the water penetrating the indurated shale and removing a portion of the soluble salts

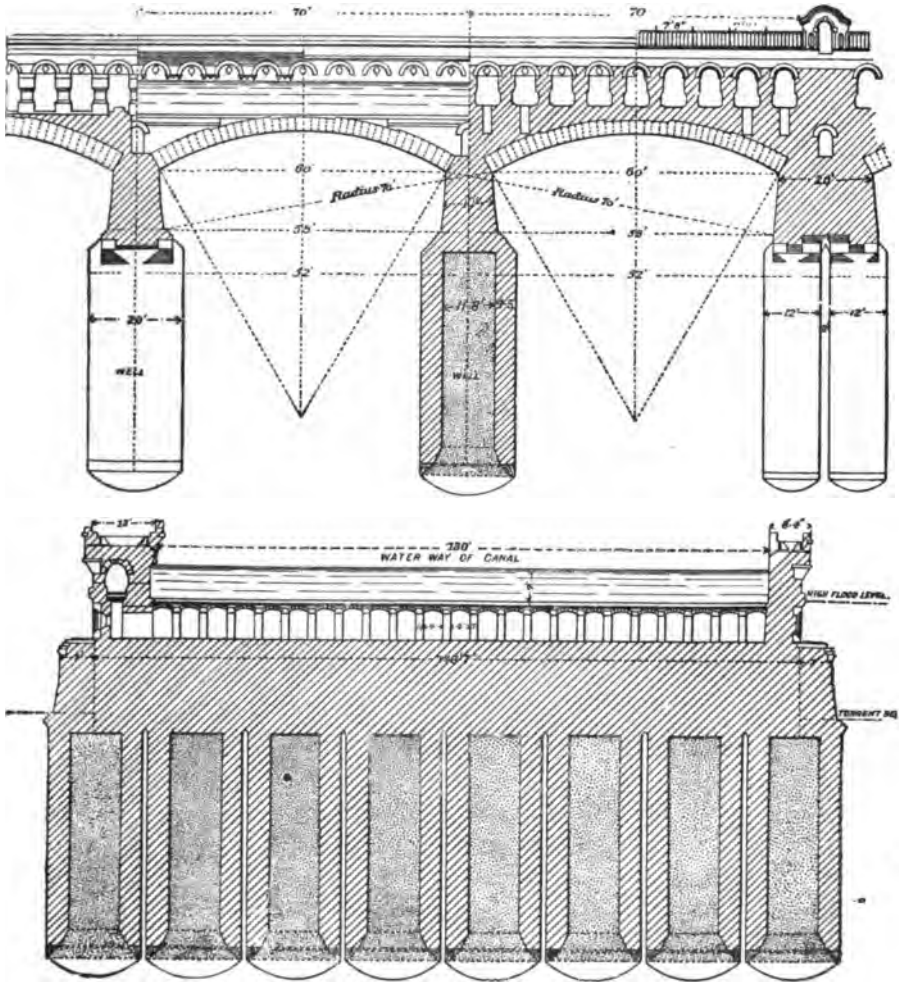

FIG. 149.—Elevation and Cross-section of Nadrai Aqueduct, Lower Ganges Canal, India.

from the seams and crevices which they fill. In many places where canals are constructed through hard shale requiring powder to loosen, they have settled badly when water was

turned through them. In a few instances the shale has swelled, causing the bottom to bulge.

One of the most important of the necessary provisions is to make safe allowance for changes of temperature which cause expansion and contraction of the flume structure. This is apt to cause openings between the concrete ends and the earth filling, and to start a leak which will rapidly enlarge under the high velocities generated, and cause a break difficult to repair, and more difficult to guard against in future.

The problem is to devise a junction between the concrete and earth that will permit movement without leakage. Such a junction has been successfully used at the termini of the Spring Canyon flume on the North Platte project, by means of successive layers of canvas saturated with tar, to make it impervious.

II. Culverts.—Where the grade of the canal is high enough to permit its passage over the intercepted drainage channel, and the volume of the torrent to be intercepted is not too great, the canal may be carried across in an earth fill, and the drainage water carried through the fill in a cast-iron pipe, or if too great for this, in a concrete conduit. The fill must be carefully constructed, observing all the rules of earth dams as to water tightness and careful connection at the ends with the natural banks, and at the bottom with good material for foundation.

The culvert should have flaring approaches to conduct the water gently into the conduit, and these should be founded deeply and provided with wingwalls to prevent percolation around them. The culvert, whether of iron or concrete, should be provided with several cutoff collars passing entirely around them, and well puddled in with good material at least one-third of which should be clay. The central portion of the fill, and all that portion adjacent to the canal water section should be wetted and rolled, or carefully puddled, to the end that no percolation from the canal shall endanger the fill. Culverts are sometimes made of wood, but this is not permanent work, as the wood in contact with moist earth does not last long. Small culverts may be made of galvanized, corrugated iron where the fill is

not too high for this, but care must be taken to allow for the retarding influence of the corrugations, and to provide all the precautions necessary with cast-iron pipes.

Where a large canal intersects a large drainage line so nearly at grade that it is not practicable to carry the canal over the drainage, the canal may be carried below grade in a pressure conduit, or the torrent may be carried over the canal in a large flume, which is called a "superpassage."

The superpassage must be amply large with a wide margin of safety to discharge the largest torrent that the drainage line may bring, without danger of overtopping and should be carried upstream on a grade of not less than 1 in 5000, a sufficient distance to intersect the natural grade of the torrent, pass under it to a depth of several feet, and terminate in a cutoff or curtain wall carried considerably deeper unless rock or impervious or indurated material is encountered sooner. No exact rules can be laid down except that the upper end of the bottom and sides of the superpassage must be so bonded and incorporated with the bottom and sides of the torrential channel as to leave no danger of the water working between and passing under or around the structure, and it must be remembered that these torrents

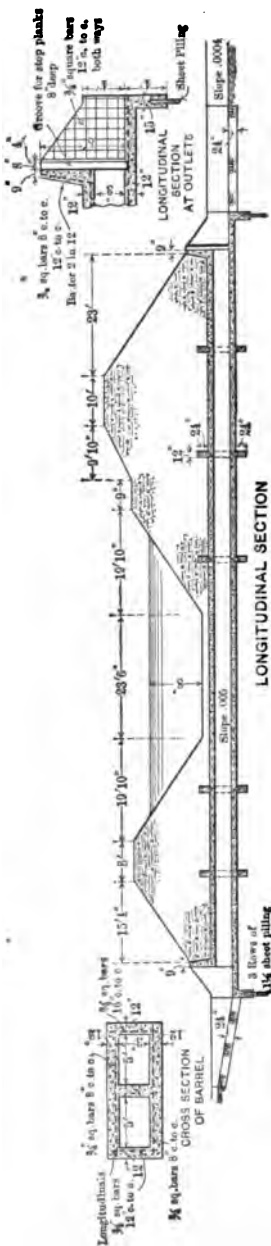

FIG. 150.—Reinforced Concrete Culvert, Lower Yellowstone Canal, Montana.



FIG. 151.—Burns Creek Superpassage, Lower Yellowstone Canal, Montana.

in flood, often erode under their channels far below the customary bed, and fill them again on the declining flow.

The superpassage must deliver the torrent to its natural channel, or other safe channel in a manner, and at a distance



FIG. 152.—Inlet to Rawhide Siphon, Interstate Canal, Nebraska-Wyoming.



FIG. 153.—Siphon Crossing under Rawhide Creek, Interstate Canal, Nebraska-Wyoming.

from the canal such as to insure against injury or menace to the canal. As the concrete superpassage will have a much smoother surface than the channel of the torrent, its effect will be to accelerate the velocity of the water, and it may be advisable

to provide a protected stilling pool or other means of checking its velocity to avoid destructive erosion. The provision of a superpassage applies mainly to cases where the torrent to be controlled is very large, and no loss of grade in the canal can be permitted.

Where one or both of these conditions is absent, it may be preferable to carry the canal under the torrent in a pressure conduit in which the pressure of the entering water forces the water to the same elevation at the issuing end, less certain losses. On account of the expense of a such a conduit built underground, it is generally necessary to make it of much smaller cross-section than the canal and give it a correspondingly greater velocity. This consumes head, or grade, and hence is to be avoided where the conservation of head is important, and must be taken into consideration when comparing this with other methods of handling such torrents. The canal should be lined with concrete for a short distance above the entrance to the structure, and the section of the conduit gradually warped from that of the canal to that of the pressure tube, so as to present no angles, nor sharp turns to the entering water, that would create eddies or otherwise retard its velocity. In this way the head consumed in entry may be reduced to a minimum, but some allowance must still be made therefor, while due allowance must also be made for the head or fall in water surface necessary to produce the velocity required in the pressure conduit. This head is found from the formula.

$$V = \sqrt{2gh}, \text{ which may be transformed into } h = \frac{V^2}{2g}.$$

In this case V = the difference in velocity between the water flowing in the canal and that required in the pressure conduit. As the water issues from the conduit into the canal it is generally necessary to change its velocity and section to that of the normal canal section. If the section is changed by warped surfaces so slowly, gently and gradually as to cause no waves nor eddies, it is possible to recover nearly all the velocity head, so that the main losses of head will be the entry head and the friction in

the conduit. When the approach and exit are properly warped, and the inside of the conduit made as smooth as practicable, these losses of head are all small except when the conduit is long, or its velocity very high, in which cases the friction losses are heavy.

It is practicable in most cases to secure an entry coefficient between 80 and 90 per cent, by proper construction of the entrance, and to recover at least 75 per cent of the velocity head by proper construction of the conduit at the exit upon grade. To secure these results, the bounding surfaces of the conduit must be very gently curved, and a distance at entry must be

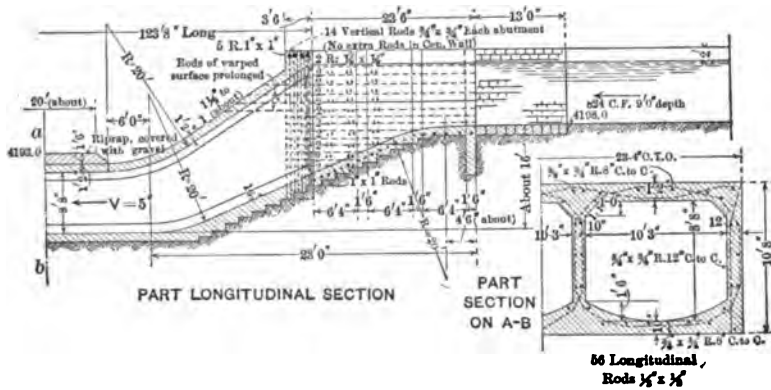

FIG. 154.—Reinforced Concrete Twin Siphon, Interstate Canal, Nebraska-Wyoming.

consumed in the transition equal to twice the difference between the greatest dimension of the original water prism, and the corresponding dimension of the pressure conduit. The issuing conduit must consume in transformation about double the distance required for the entrance by the above rule.

The junction of the structure at both ends must be safeguarded by curtain and wingwalls, and the usual precautions taken to prevent percolation around them.

The pressure conduit must be built well below the grade of the torrent it crosses, in order to avoid the danger of a washout.

Where a flume or a pipe is required on a canal line, it is

advisable to give some increased grade, in order to induce an increased velocity and to force the required quantity of water through, without building a structure as large as would be

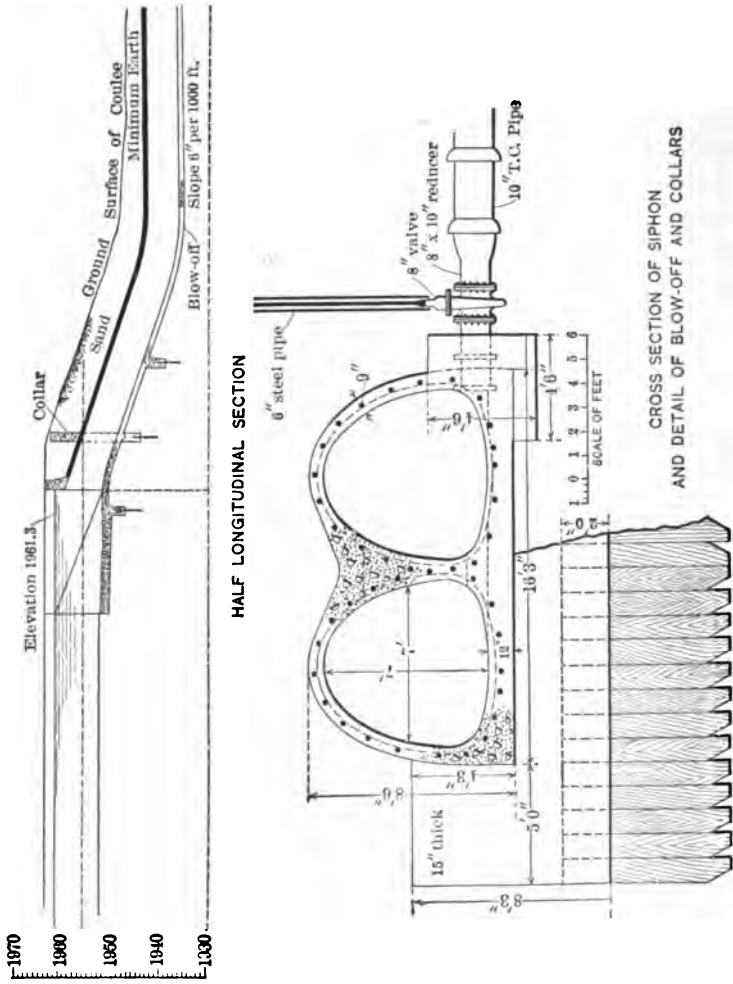

FIG. 155.—Reinforced Concrete Twin Siphon, Fox Creek Crossing, Lower Yellowstone Canal, Montana.

required with a low velocity. The quantity of water carried is expressed by the equation, $Q = Av$, where A is the area of cross-section of the conduit, and v is the mean velocity of the flowing water. Hence, the greater the velocity, the less may be the area of cross-section, and as a flume or pipe will admit of



FIG. 156.—Main Canal, Concrete Lined, Okanogan Project, Washington.

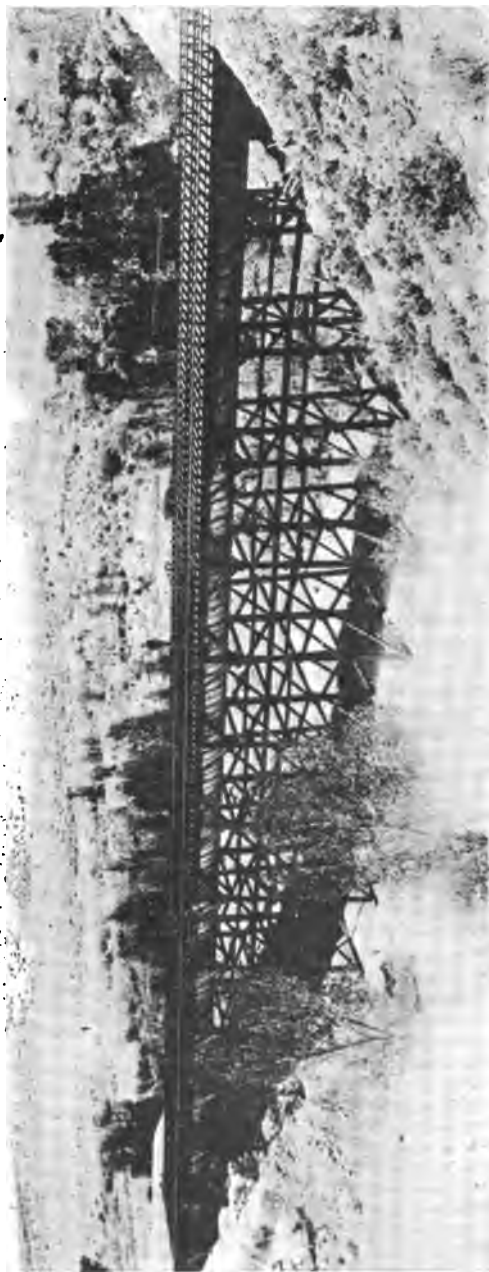

FIG. 157.—Happy Cañon Steel Flume, Uncompahgre Valley, Colorado.

high velocities without injury much expense may often be saved by increasing the grade, and velocity, at the entrance of such a structure. The high velocity is also desirable to prevent the deposit of sand or gravel in a pipe.

12. Pipes.—The use of pipe for conveying and distributing water for domestic use is nearly universal, and it has the important virtues of cleanliness, convenience and economy of water. The great expense involved generally prohibits its use for the large volumes of water handled in irrigation, except in Southern California and such localities where water has a very great value, and in special cases where pipe may be used as inverted siphons to carry water across depressions under pressure, or around steep hillsides where canals cannot be built. Short pipes are also used as culverts to carry drainage waters under roads, railroads or canals.

The material of construction may be cast iron, sheet steel or iron, wood, reinforced concrete, vitrified clay, or cement. When properly constructed, reinforced concrete is the most permanent, and has been successfully used by the Reclamation Service for heads as high as 110 feet. For heads much greater than this, steel, cast iron or wood may be used. For heads below 20 feet clay tile or cement is sometimes employed without reinforcement.

Wood pipe is the most widely used pipe for irrigation, but the use of concrete is increasing, as it becomes better known and the cost of wood increases. Wood decays rapidly unless kept saturated with water, and its decay is much hastened by contact with earth, unless the saturation with water is thorough and continuous. Confinement of water under high pressure is the best means of keeping it saturated, and hence wood pipe should be used only under high pressure, unless it is laid under water or in ground perpetually saturated. Where pipe is exposed to the air, or to dry earth it may require a pressure of 50 feet head or more to force the water through the pores of the wood fast enough to supply the evaporation from the surface. The head required is of course much greater in an arid than in a humid region with less evaporation. Where the head is less

than 100 feet, especially in arid regions, the pipe should be protected from contact with earth, and its life may be greatly prolonged by keeping it well painted outside. A good practice is to build a pressure pipe of wood for the distance where its pressure head exceeds 50 feet, and build the ends of reinforced concrete where the pressure is less. The pipe should be left full of water during the non-irrigation season, and any considerable loss from leakage should be replenished. Redwood is the most durable wood for this use, but cedar and Douglas fir are good and many varieties of pine have been used.

Wooden pipe was formerly manufactured by boring the center out of logs, and such pipe is reported to have had a durability of over 200 years in England, and over 100 years in Philadelphia, under conditions where it was continuously saturated with water. The bored log is very wasteful of material, and has been superseded by two modern types, both widely used in irrigation work, namely the continuous stave pipe, and the wire-wound pipe.

Continuous stave pipe is built in place of staves carefully milled from selected lumber, to have concentric circular surfaces and radial edges. The ends of the staves are arranged to break joints, and are joined by metal plates inserted in sawkerfs in both staves, and slightly wider than the stave. The staves are held in place by steel bands, the ends of which are lapped in a cast-iron shoe, and one is fitted with a screw nut which is used to tighten the band. Specifications found in Chapter XXII of this book give in detail the best modern practice.

Wire-wound wooden pipe is made in joints of convenient length, by placing the staves in the position desired, and binding them firmly in that position by winding heavy wire around them in spiral form. The lengths manufactured vary from 20 feet for small diameters, to 8 feet for the largest. The pipes are usually from 4 inches to 24 inches in diameter, though larger and smaller sizes are sometimes used. Larger sizes than 36 inches can best be made on the ground, of the continuous stave type.

Where water freezes in the pipe during winter it should be

carefully examined for leakage before the opening of the irrigation season, and repaired if necessary.

There is little economy in using wooden pipe for pressures exceeding 200 feet, as above that head the necessary steel in the bands is nearly sufficient for heavy steel pipe, which is thus much cheaper. Wood pipe, has, however, been used for heads up to 400 feet, where the short length of such head did not justify a change in design.

Reinforced concrete pipe may be manufactured in place by means of portable forms, and good results have been obtained in this way. It is necessary to keep the work going continuously, or nearly so, as concrete does not bond well with other concrete that has been cured. The difficulty of entirely accomplishing perfect continuity, and of obtaining thoroughly first-class work under the handicaps of field conditions, led to the introduction of another method, by which the pipe is constructed in sections of about 8 feet, in a yard where ideal conditions can be approximated and the concrete can be made particularly dense and ideally cured. After thorough seasoning, these are hauled to the field, and placed during weather as cold as permissible without freezing the mortar used in forming the joints. A movable collar form is placed at each joint, and a rich cement mortar is poured in at the top and thoroughly rammed.

As soon as the forms are removed, the joints are covered with wet burlap and kept moist continuously for several days. By placing the pipe in cold weather while it is contracted by cold, any rise of temperature places it in compression and tends to prevent cracks. It should be backfilled as soon as possible after seasoning the joints. Pipe 46 inches in diameter, made and laid in this manner near Hermiston, Oregon, has withstood a pressure of 110 feet for several years without notable leakage or any repair.

Steel pipe is often used for heads exceeding 60 feet, but is seldom economical for a less head. It is commonly formed by curving a sheet of steel till the edges lap, and riveting them in that position. If considerable head must be withstood it is greatly strengthened by having two rows of rivets, parallel.

Another and more efficient method of riveting is to wind the steel in a spiral and fasten the spiral lap seam by a single row of rivets. The transverse seam is formed by forcing the end of one joint into another far enough to rivet, or if the pipe is especially heavy, making a butt joint with an exterior sleeve riveted to each pipe. The life of the pipe is greatly increased by keeping it well coated with paint or tar.

The smaller sizes of steel pipe are formed by welding the longitudinal seams instead of riveting, and are joined by screwing the ends into exterior sleeves made to fit.

Lock-bar pipe has the longitudinal joint formed by upsetting the edges of the plate, and inserting them in grooves of a bar which are then closed by hydraulic pressure. This makes a joint equal to the strength of the plate if the workmanship is good, and avoids the interior roughness caused by rivets.

The use of small pipe in distributing irrigation water is rapidly growing as water becomes more valuable, and the means of the irrigators grow. Where this is simply a substitution for open ditches it is customary to employ cement pipe, which can be manufactured in place by machines used for the purpose. Cement pipe without reinforcement is often used to cross undulations involving pressures up to 15 feet, and has been used for 20-foot pressures. In these cases, however, it must be built with especial care, and heads above 10 feet should be avoided when practicable, or a light reinforcement in the form of a spiral steel wire may be used. The use of cement pipe as of cement-lined ditches is growing and is to be commended and encouraged.

There are many formulæ for computing the discharge capacity of pipes, all based more or less on experiment, seventeen of which are given in the *Engineering Record*, Vol. LXVIII, p. 667. The most noted of these perhaps are those of Bazin, D'Arcy, Kutter and Weisbach, which all differ considerably in results. A careful study of these, and the reasoning on which they are based, leads to the conclusion that great refinement of computation is useless, and that we can hardly hope with present knowledge to predict much nearer than 8 or 10 per cent, the capacity of any pipe in advance of its construction, and that



FIG. 158.—Steel Bridge and Wood-stave Pressure Pipe, Yakima Valley, near Prossner, Washington.



FIG. 159.—Steel Forms and Reinforcement for Concrete Pressure Pipe, Boise Project, Idaho.



FIG. 160.—Removing Inside Steel Forms from Concrete Pressure Pipe, Boise Project.



FIG. 161.—Manhole and Concrete Collars on Concrete Pressure Pipe, Boise Project.

such a margin of safety should usually be provided where the capacity is important.

The U. S. Reclamation Service has adopted the following formulæ for the capacity of pipes used in irrigation and drainage:

Wood-stave pipe.....	$Q = 1.35$	$D^{2.7}$	$H^{.555}$
Cast-iron pipe.....	$Q = 1.31$	$D^{2.7}$	$H^{.555}$
Concrete pipe.....	$Q = 1.24$	$D^{2.7}$	$H^{.555}$
Riveted steel.....	$Q = 1.18$	$D^{2.7}$	$H^{.555}$
Drain tile.....	$Q =$	$D^{2.7}$	$H^{.555}$

where Q = Discharge in cubic feet per second;

D = Diameter of pipe in feet;

H = Available head in feet per 1000.

13. Tunnels.—Where the canal location must leave the contour grade line in order to avoid a long detour around a ridge or hill, or to escape a hazardous location on its steep slopes, it may pass through the hill in a deep cut, or if this is too deep, may tunnel through. Whether a cut or tunnel is to be preferred depends mainly upon the depth of cut and the character of material, and is chiefly a question of cost. Other conditions being equal, a tunnel is to be preferred, as it will generally give less trouble and expense in maintenance. There is frequently presented also the alternative of going around on a grade line in a flume or canal, or a combination of both. The cost must be largely in favor of the latter to justify its construction, as side-hill canals and flumes are expensive to maintain, and may be very hazardous. This depends largely on the material, and is not easy to estimate in advance. Cases are not rare where a canal located around a hill gave so much trouble by seepage and developing slides that it was later abandoned for a safer location in tunnel.

In a majority of cases tunnels require lining to prevent caving or swelling of the material in which they are built, and in many instances where this is not the case lining may be advisable to present smoother surfaces to the flowing water, reduce the friction and thus increase the capacity. This is

generally the case where grade is valuable, but where there is a surplus of grade and the rock is hard and firm, the lining may be omitted from a tunnel of moderate size. A small tunnel with good smooth concrete lining will discharge nearly twice as much water as one with rough rock interior of the same dimensions and grade. A lining may in some cases be required to prevent loss of water through crevices in the rock, but such conditions are infrequent in material firm enough to stand without lining.

The smallest tunnel in which it is economical to carry on heavy work is about 4 feet wide and 6 feet high, and there is little or no economy in making a tunnel smaller than this. It is best to leave about a foot of vacant air space above the water in any tunnel, to prevent waves or any chance obstruction from causing the water to touch the top of the tunnel, and thus causing it to "seal," that is to fill to the top, and thus increase the friction which would reduce the velocity and resulting discharge.

It is generally advisable to construct the top of a tunnel in the form of an arch. This shape has a tendency to resist caving of the top and gives the maximum holding power to any lining that may be provided. It also provides an air space that is effectual against sealing without sacrificing much cross-section for this purpose. The sides of the tunnel are generally straight vertical lines, and the bottom a straight horizontal line, or a slight curve concave upward. It is generally considered cheapest to make such simple lines, especially in case lining is required, for which forms must be provided. This advantage, however, is not great, and wherever the ground to be tunneled is insecure, greater resistance to caving may be secured by giving the perimeter of the tunnel a curved form, so as to present arch action in every direction against outside pressure. For this purpose a circular section is sometimes provided, but this is inconvenient of construction and not entirely logical for its purpose. The first tendency of caving ground is downward in obedience to gravity, and where this is resisted, and the mobility considerable, a secondary tendency is in a horizontal direction. It is therefore logical to build the top of the tunnel on a curve of shorter radius than that of the sides or bottom, but to curve

these also, if outside pressures are to be expected. A logical and convenient shape conforming to these principles, has become standard, and is as follows: The top of the tunnel is a half circle, drawn to such radius as the desired capacity requires, which may be indicated by the symbol R . From each end of the horizontal diameter, with a radius $2R$, an arc is described connecting with the half circle and continuing its lines downward. From highest point, or apex of the circular top as a center, with a radius $2R$, an arc is described to form the bottom or invert of the tunnel, intersecting the sides. This shape is shown in Fig. 250, and is sometimes called a "horseshoe" section, for obvious reasons.

Clay and shale and some other materials have a tendency to swell when exposed to atmospheric influences and may continue the swelling process long after lining has been placed. Where such tendency exists, it is important to employ a curved section of lining in order, by arch action, to resist the thrust of the "swelling ground."

Where it is desirable to build the tunnel of the smallest economical size, the invert may be drawn to a radius of $3R$ instead of $2R$, and by giving the R a value of 2 feet, we obtain an extreme height of 6 feet and an extreme width of 4 feet, which is about the minimum desired. The standard section, however, Fig. 249, produces a greater hydraulic radius, and hence involves less friction losses, and wherever it gives a total height of 6 feet or more, is more convenient and hence more economical in construction and operation.

The equipment and operations for tunnel construction vary widely. They depend chiefly upon the character of material and the length of the tunnel.

Tunnel work at best is quite slow. The room for work is so restricted that only a few men can engage upon it at one time, and if the tunnel is very long it generally is the feature that determines the necessary time consumed in the construction. The utmost speed therefore becomes important and it is customary to work night and day upon both headings.

If any central portion of the tunnel is near enough the surface

to be reached from a shaft of moderate depth, this may be made a means of expediting its completion by affording other points of attack. Sometimes it may be entered at the side from a canyon nearby through a branch tunnel called an adit. In deciding upon the location of the tunnel it is not uncommon to deviate from a straight line sufficiently to permit the use of an adit to cheapen construction and expedite completion.

The length of a tunnel not only increases the time of construction but greatly increases the unit cost. It determines the distance through which men must travel to and from their work and through which all the excavated material must be transported and all of the materials for timbering and lining the tunnel must also be taken, together with powder and other materials for construction.

A long tunnel must also be provided with ventilation. The gases generated by explosives are unfit for breathing and may be very injurious or fatal if taken into the lungs in considerable quantities. It is therefore necessary to provide ventilation by some means. With a short tunnel it may be feasible to work only alternate shifts or to provide such intervals between shifts that the gases will dissipate themselves so that artificial ventilation may not be necessary. As the work advances farther and farther from the entrance, artificial ventilation becomes more and more necessary, especially if speed requirements are such as to prevent the suspension of work for considerable intervals. Necessary ventilation is generally provided by running light sheet-iron pipe from the portal or from a shaft and with a blower either pumping air from the heading or forcing fresh air in to displace it. Usually the suction process is used immediately after the blast to bring out the concentrated gases. When these are fairly well disposed of the current is reversed and fresh air blown in next the heading. In this way only a few minutes need be lost from the work after a blast and by setting the blast off just before meal time the atmosphere is satisfactory for the resumption of work immediately after the meal is finished.

There is a large variation in the speed that can be achieved

in constructing a tunnel, even where the best facilities are provided. Where the material is of shale or of indurated sand or similar substances which are sufficiently coherent to stand temporarily without much timbering and yet are soft enough to be cut rapidly with power augers and do not require the slow process of drilling, the work can proceed rapidly and 20 or 25 feet of progress may be made in one day on a single heading. Where the rock is hard, requiring much drilling, the process is necessarily slow and may be only a tenth of what it would be under the most favorable circumstances.

TABLE XXXII.—TUNNELS

Project	Tunnel	Capacity, Sec. ft.	Length, Feet	Cost Excl. G. E.	Cost per Foot
Grand Valley.....	No. 1.....	1425	3,723	\$265,200	\$71
Grand Valley.....	No. 2.....	1425	1,655	117,400	71
Grand Valley.....	No. 3.....	670	7,292	334,100	46
Uncompahgre....	Gunnison.....	1000	30,645	3,100,000	101
Sun River.....	Pishkun No. 1.....	1000	695	54,100	78
Sun River.....	Pishkun No. 2.....	1000	1,022	80,900	79
Sun River.....	Pishkun No. 3.....	1000	2,277	142,700	63
Klamath.....	Main Canal.....	1200	3,300	190,700	58
Belle Fourche....	S. Canal.....	350	1,306	33,200	25
Strawberry.....	Strawberry.....	600	19,897	1,076,000	54
Strawberry.....	Power Canal No. 1..	500	800	27,600	34
Strawberry.....	Power Canal No. 2..	500	705	21,800	31
Okanogan.....	Conconully Outlet..	900	395	12,800	32
Yakima (Tieton)..	6 tunnels.....	300-350	11,863	397,100	33
Shoshone.....	Corbett.....	1000	17,355	1,133,000	65

The most difficult tunnel work, however, is where the material to be penetrated is running sand which requires close tight timbering to prevent enormous caves and filling of the tunnel with loose sand. Various means of solidifying this have been suggested, but without much success so far. One method is to inject water into the sand ahead of the work, which makes it more coherent and affords time for placing timber after excavation. Another suggestion is to inject cement grout for the same purpose. These processes present difficulty in securing an even

distribution of the injected material, but where this can be accomplished they help materially in holding the refractory sand.

The above table of tunnels constructed by the Reclamation Service, shows the entire cost excluding overhead, general and indirect charges, and show a great variety of unit costs. The highest unit cost, that of the Gunnison Tunnel, is due partly to the fact that it is the longest in the list, but still more to the extremely difficult and hazardous conditions there encountered. These included great deposits of mud and gravel which were difficult to hold, large quantities of water, much of it scalding hot, and numerous difficulties with carbon dioxide and explosive gases imprisoned in the rocks and liberated by the tunnel work. The construction was frequently shut down from these means; heavy pumping, elaborate ventilation and equipment were required, and in the process many lives were lost.

Tunneling is a highly developed specialty, requiring for economical and efficient prosecution a high degree of skill in the use of explosives, in the timbering and holding of refractory material, and in organizing, training, and operating a crew to work efficiently under cramped and disagreeable circumstances.

14. Highway Crossings.—In general it is necessary to provide highway bridges where irrigation canals cross public highways in use at the time the canals are constructed. These should usually have abutments of concrete or steel cylinders filled with concrete, as wood will rapidly decay in contact with earth. The superstructure of small bridges may properly be built of wood, and the larger bridges requiring trusses may have all compression members of wood and the tension members of steel. It is very undesirable to permit any piers in the water prism of the canal, as they cause some loss of head, and catch driftwood, weeds, etc., and increase maintenance cost in several ways.

Where it is necessary to cross existing railways, the railway company is sure to require a very safe structure, and there is sometimes a tendency to carry this requirement to an extreme. There should never be reluctance to provide such structures



FIG. 162.—High Line Canal, Spanish Fork Valley, Utah, Covered to Protect against Land and Snow Slides.



FIG. 163.—Headgates, Sluice Gates, and Sand Basins, High Line Canal, Spanish Fork Valley, Utah.

with ample margin of safety, as a failure might lead to the wreck of a railway train, an accident usually far more serious than a canal break. Crossings of railways established after the canal is built should be at the expense of the railway, and should be of the same character and margin of safety as those built at the expense of the canal authorities. The same rules apply to highway crossings required after the construction of the canal.

Where the grade of the railway or highway is several feet above the surface of the canal water, and the canal is not too large, it is best to carry the road across on a fill over a culvert provided for the canal water. This avoids interference with the road in any way, and the earth distributes the pressure upon the culvert. Where the grade of the canal is about the same as that of the railroad, it is seldom that the latter is willing to change its grade, and it becomes necessary to introduce a pressure conduit to carry the canal under the railway. The chief objection to this is the tendency to collect sand and silt in the conduit under the railways. Where possible the conduit should be given a velocity sufficient to carry through any material the canal can bring in. For this purpose, velocities of 3 feet per second for silt, 4 feet for sand, and 5 feet for fine gravel will prevent deposit, but higher velocities may be required to pick up and carry out material previously deposited. Where it is not feasible to provide increased velocities, it may be necessary to provide that the lowest point of the conduit be at one side of the railway, where it may be cleaned out through a manhole. This is seldom necessary unless the canal is heavily silt bearing.

15. Sand Traps.—The frequent presence of sand in canals where it is often a serious nuisance, requires the employment of devices by which it may be removed and these are variously called, sand traps, sand boxes, sand gates, and sluicing devices. On p. 250 reference occurs to devices for preventing or minimizing the entrance of sand into a canal from the river. These are not always possible, and where provided are seldom completely effective, and hence, where water is taken from a sandy stream, it is usually necessary to employ some means to get rid of the

sand entering the canal. In addition to this, the canal may receive sand from side drainage taken into the canal.

The objections to sand in the canal are several:

1. It tends to deposit in siphons near the inner bank on curves, and at other points where the velocity is checked or eddies occur, and to form bars which reduce the capacity of the canal, and cause much annoyance and expense in their removal.

2. Sand occurring in water carried through siphons, flumes, or lined channels at high velocities, has a tendency to wear such channels, or other structures subject to the abrasion of the sand.

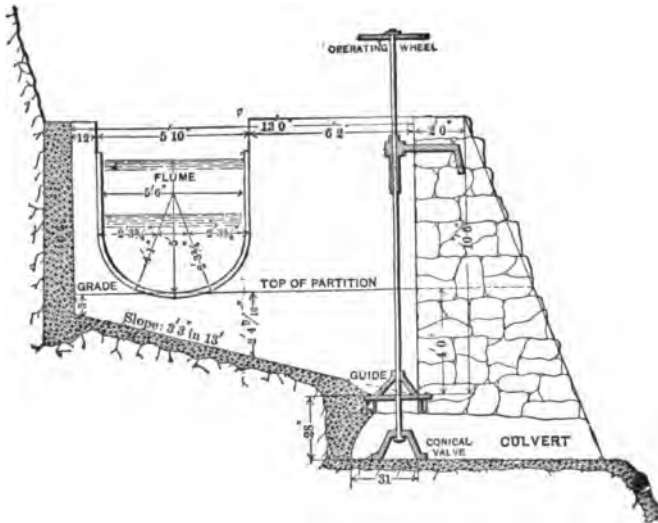

FIG. 164.—Cross-section of Sand Box, Santa Ana Canal, Cal.

3. Sand occurring in water to be used for power causes rapid wear and destruction of water wheels.

4. Where sand is successfully carried through the canal system to the farm, which is difficult to accomplish, it soon fills the farm distributaries, and as it contains very little fertility it is a nuisance without redeeming benefits.

5. Sediments of all kinds and sizes carried in a feed canal to a reservoir tend to fill the reservoir and destroy its storage capacity.

The first four of these objections do not apply in the same degree to the finer sediment in the form of silt or clay, which have less tendency to deposit and clog the works, and contain a much larger percentage of available plant food, and although these finer sediments do cause some annoyance and expense, they are, when in moderate quantities, much to be desired for their fertilizing value when deposited in the field, and such sediments deposited in moderate quantities in the canal system, tend to seal it and thus to reduce seepage losses, especially where the canal is located in coarse and porous materials. A film of clay over the perimeter of a canal also tends to reduce friction and thus increase discharge.

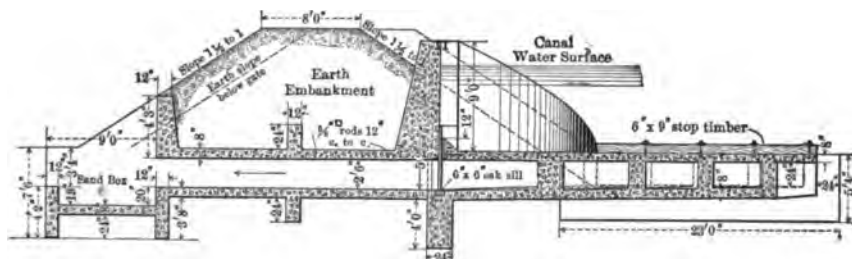

FIG. 165.—Sand Box, Leasburg Canal, Rio Grande Valley, New Mexico.

Fortunately the coarser particles, which are so objectionable, are more easily separated from the water by settlement, and it thus becomes practicable to eliminate them in a large degree.

The measures available for combating the sand nuisance may be divided into two classes, one of which is essentially preventive and the other curative:

1. Processes of settling, sluicing and skimming the water so as to prevent the entrance of sand into the canal. These are preventive measures.
2. Processes of settling the sediments in basins or depressions in the canal system, and sluicing them back into the stream, or into other drainage lines.

The preventive measures are described in the article on headworks on p. 248. Various devices are employed to rid the canal waters of sand.

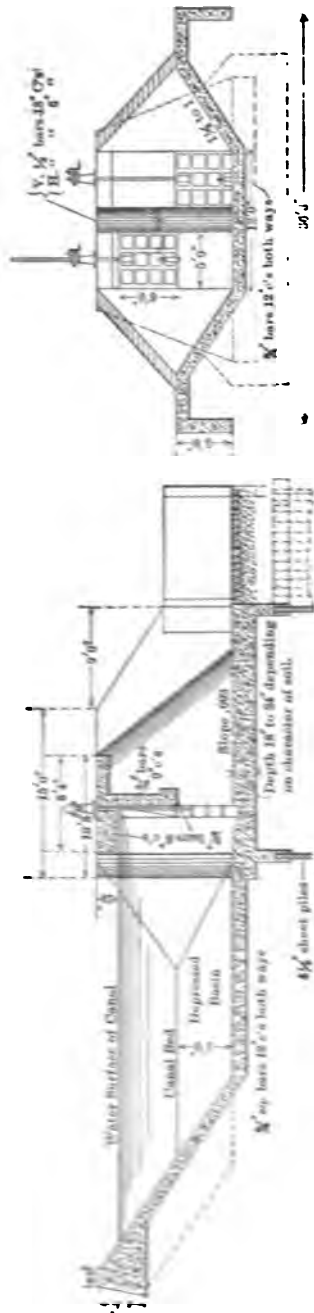

FIG. 106. Standard Sluiceway and Sand Gate, Lower Yellowstone Canal, Montana, North Dakota.

In the vicinity of cross-drainage or of the parent stream the canal may be given an abnormally large section and a depressed bottom, and the slow velocity corresponding to the enlarged section causes a deposit of the heavier and coarser solids, which are deposited in the bottom of the enlarged section. A gate or set of gates is provided with its sill at the bottom of the depressed portion, and when this is opened, the increased grade induces a high velocity over the deposited sediment, and the rushing waters carry it out into the drainage line utilized, which is flushed by its natural freshets.

The efficiency of this method may be increased by providing a false bottom to the canal on a level with its normal bed. This false bottom may be formed of triangular bars with a sharp edge upward, spaced a slight distance apart, so that sand settling will fall through between the bars, to the bottom of the depression. The space below this false bottom, should be provided with curved guide walls or grooves to guide the water to the sluice gates.

The false bottom serves to prevent upward currents and

eddies that retard settlement of the sand, and the curved guide walls accelerate the sluicing velocity of the water and facilitate the movement of the sand under its influence. The channels between the guide walls may be each provided with a separate gate so that they may be separately sluiced if desired. The combined capacity of all the gates should be somewhat greater than the capacity of the canal, in order to achieve maximum efficiency.

Where the canal waters are carried across a stream or a large ravine in a flume, this may be provided with a series of hoppers reaching below the grade of the flume, in which the sand may settle, and a valve in the bottom of each hopper may be opened at proper intervals to let the sand fall out.

Some device of this kind is generally employed just above a power plant fed by a canal from a sandy stream. It is also wise to provide such an arrangement for desilting above a pressure pipe or inverted siphon where low velocities occurring at times when the canal is being used at part capacity might clog the pipe with deposits of sand if not prevented.

Desilting devices are in successful practical operation in numerous localities, and their efficiency is greatly assisted by the fact that the coarser particles of sand have a tendency to travel on or near the bottom of the stream. A considerable proportion of the coarsest are simply rolled along the bottom in miniature waves or dunes of sand, and are easily deposited in traps like those described.

In some cases settling basins are arranged in duplicate, side by side, so that while one is in use the other may be cleaned, and thus by alternating the closure of the canal is avoided.

CHAPTER XV

STORAGE RESERVOIRS

1. Classes of Storage Works.—Reservoirs are employed to regulate the flow of water in such manner as to accommodate the rate of use, and prevent waste when the supply exceeds the demand, holding it for use at the time the requirements exceed the natural supply.

The storage of water for ordinary irrigation purposes requires favorable topographic conditions to make it financially feasible. Such conditions must make possible the storage of a large quantity in a broad capacious basin, wholly or partly natural, where the dam or other structures necessary to complete it are of moderate dimensions and cost, as compared with the quantity of water stored. A location where storage can be obtained at moderate cost is called a reservoir site, and such sites may be classified with respect to their topographic features into four classes as follows:

1. Natural lake basins;
2. Those located on natural drainage lines, the flow of which they regulate;
3. Those located in depressions away from natural streams, requiring the water for storage to be conducted to them;
4. Artificial reservoirs located in places having no special natural adaptation to such use.

Natural lakes are often, in their natural state, important regulators of drainage waters which they receive. By controlling the outlet, by means of a dam and regulating gates, a large amount of storage may often be secured very cheaply; the cheapest storage works in the world in proportion to capacity, are those which utilize natural lake basins.

The most abundant reservoir sites are those on natural drainage lines, but they require careful precautions to safely discharge the flood waters of the stream, and are often quite expensive in proportion to capacity.

Many natural depressions in plains or benches partially enclosed by high ground can be converted into reservoirs by banks of moderate dimensions to close the gaps between the hills, and many natural "dry lakes" can be made available by cutting outlets to draw off stored waters. Such reservoirs must have their water supply carried to them by canals from natural streams. Some reservoirs are constructed on small drainage lines on account of favorable topographic conditions, and receive their main water supply through feeders from larger streams in the neighborhood.

Natural depressions, forming dry or intermittent lakes, are sometimes caused by the collapse of subterranean caverns caused by the solvent and erosive action of subterranean waters, or otherwise. Depressions thus formed are unsuitable for reservoirs on account of the easy escape of the waters through the subterranean passages in their vicinity. Dry lakes should be carefully examined for the existence of those conditions, before being adopted as reservoir sites.

Artificial reservoirs are sometimes constructed by excavating basins and using the material in the formation of banks to confine the water. Such reservoirs are very expensive per unit of storage capacity, and can be used only in cases where water has a high value, as for domestic purposes or the irrigation of gardens.

Shallow reservoirs are usually to be avoided, as the losses from them by evaporation and percolation are relatively large, and where they are shallow enough to permit the sunlight to penetrate to the bottom, they are likely to be infested by aquatic vegetation. To prevent the growth of this, shallow reservoirs for city supplies should be covered to exclude the sunlight.

2. Selection of a Reservoir Site.—Among the more important considerations affecting the feasibility and value of a reservoir site are:

1. Its relation to the irrigable lands.

2. Its relation to the water supply.
3. The topography of the site.
4. The geology of the site.

A careful examination should be made of the region where storage is desired, to discover all possible reservoir sites and compare their value and cost in order that the most favorable may be selected. This requires a practiced eye and trained judgment capable of selecting the most advantageous locations for survey, otherwise much time and money may be wasted on the survey of indifferent locations.

The reservoir must lie at a sufficient altitude above the irrigable lands to permit the delivery of water to them by gravity flow, or in special cases by pumping to moderate heights, and should be as near as possible to those lands so that the losses in transportation may be small. The site must be at such a point as to intercept a sufficient water supply, or so that such a supply can be conducted to it. Where the reservoir is on a stream, it often happens that it is such a distance above the lands to be irrigated that when the water is needed it is released from the reservoir and allowed to flow down the stream bed for some distance, until it reaches the point where it is necessary to divert it to reach the lands for which it is intended. If this distance is long, consideration must be given to the losses in transit to be expected. Due regard must also be had to the drainage intercepted by each possible site, and the bearing of this element on the water supply.

It is always desirable to locate the reservoir as near as possible to the irrigable lands, as otherwise, the long time required in transit from the reservoir to the lands makes it difficult to regulate the water supply according to the fluctuating needs of irrigation, and much water must be wasted most of the time in order to insure a full supply when needed.

3. Geology of Reservoir Sites.—Having ascertained the desirability of the reservoir site topographically and hydrographically, the geology should be carefully studied, to ascertain the character and dip of the strata underlying the proposed reservoir. The geological conformation may be such as to

contribute to the efficiency of the reservoir, or it may prove so unfavorable as to be irremediable by engineering skill. A reservoir site which is situated in a synclinal valley is generally favorable. In this the strata incline from the hills towards the lower lines of the valley, and water which may fall on to these hills will find its way by percolation into the reservoir, thus adding to its volume. An anticlinal valley is much less favorable for a reservoir site. In such a valley as this the strata dip away from the reservoir site and may permit of the escape of much of the impounded water. A class of geological formation intermediate between these two is that in which the valley has been eroded in the side of strata which dip in one direction. Here the upper strata tend to lead water from the adjoining hills into the reservoir, while the strata on the lower side tend to carry it off from the reservoir. If the surface of the proposed reservoir site is composed of a deep bed of coarse sand or gravel the percolation through this may be so great as to seriously impair the efficiency of the reservoir.

The most careful scrutiny should be given to reservoir sites in regions of extensive lava flows, as such formations often contain hidden crevices and caverns through which the water may escape from the reservoir. Oregon, Idaho and Arizona each furnishes an instance of bad holding power of a reservoir built in lava formation.

Limestone and gypsum formations are also liable to caverns and in gypsum especially these are frequent, and are subject to rapid enlargement by erosion and solution by the waters that may leak through them. Natural basins or "dry lakes" are sometimes formed by the collapse of such caverns, and where it is proposed to employ such basins as reservoirs, careful study should be made of the geology before deciding upon its construction.

Where caverns, crevices, or gravel beds under the reservoir afford easy escape for ground water, no dependence should be placed upon an overlying blanket of soil to make the reservoir tight, as the losses by vertical percolation through such soil

will be too great for satisfactory results, provided there is free escape for the percolating waters.

To illustrate this, let us suppose a reservoir covering 5000 acres of any average depth of 50 feet, and having, therefore, a storage capacity of 250,000 acre-feet, and that the ground surface of the reservoir site is composed of average alluvial soil, underlain with coarse gravel, or with cavernous rock, which affords ready escape for any water reaching it. The table on p. 235 shows a coefficient of seepage from good canals of .5 foot per day. The seepage loss from the reservoir would at that rate, be when full, 2500 acre-feet per day, or a rate sufficient to empty the reservoir in 100 days. The great head on a deep reservoir would greatly accelerate the rate of seepage, and the decline of the water would diminish the wetted area, but it is readily seen that such a reservoir would be worthless for most purposes. The good holding qualities of many reservoirs with earth bases is explained by the fact that in some cases they are backed by rock which is nearly impervious, and in which such crevices and interstices as exist are soon filled with water, and are of such minute dimensions as to make the escape of such water extremely slow. In other cases the seepage from the reservoir is large at first, but having no ready escape to an open stream, gradually raises the ground water, until this rises to the surface, and then we have a tight reservoir, in which the leaks are sealed with water, which can escape only very slowly, in a direction nearly horizontal.

4. Leakage from Reservoirs.—It is useful in this connection to review some instances of reservoirs that have developed abnormal leakage in such degree as to become nearly or quite useless.

Tumalo Reservoir.—This reservoir was built by the State of Oregon in connection with the Tumalo Project. Prior to its construction, a board of engineers recommended that it be first built to only partial capacity, and that it be tested for water tightness before heavy expenditures were incurred. It appeared, however, that this would delay completion until the appropriation for its construction would lapse into the general fund,

the wise recommendation was disregarded, and the dam was completed to its full height. Water was delivered to the reservoir through the feed canal, until it had risen about 20 feet above the outlet. At this juncture a large hole developed in the bottom of the reservoir about 1000 feet from the dam, discharging over 200 cubic feet per second, which soon emptied the reservoir. This hole was puddled, and the water again turned in, but new breaks in the bottom occurred, and it was found impossible to raise the water again to the height first attained.

The holes developed varied from small cracks to as much as 50 feet across, and from 10 to 30 feet deep. Sometimes the ground would drop very suddenly. Considerable money was spent in puddling these holes, and the rapid flow through them has been stopped; but seepage over the whole submerged area occurs to an extent sufficient to render the reservoir worthless for storage.

When the water covered a surface of 30 acres, the observed loss was from 6 to 8 inches per day, which is normal seepage through good earth, but too rapid for storage requirements.

The country rock is of igneous origin and is so fissured that the ground water escapes rapidly to the Deschutes river, thus giving free vent to the water of the reservoir as fast as it can penetrate the surface soil.

The *Deer Flat Reservoir* is located on the valley near Boise, Idaho. It is formed by joining a series of low hills by embankments, and is supplied with water by a canal from the Boise River. It is about 10 miles from the nearest point of the Boise River, and its bottom is about 100 feet above the river at that point. When full it covers an area of 9800 acres, and contains 180,000 acre-feet of water. It was placed in service in 1909, when about 60,000 acre-feet of water were run into it, the greater part of which was lost by seepage, and not more than 17,000 acre-feet was in the reservoir at one time, 2500 acres being then submerged. The next year 3900 acres were submerged, and about half of the water was lost by seepage. Many persons believed the reservoir was doomed to failure on account of

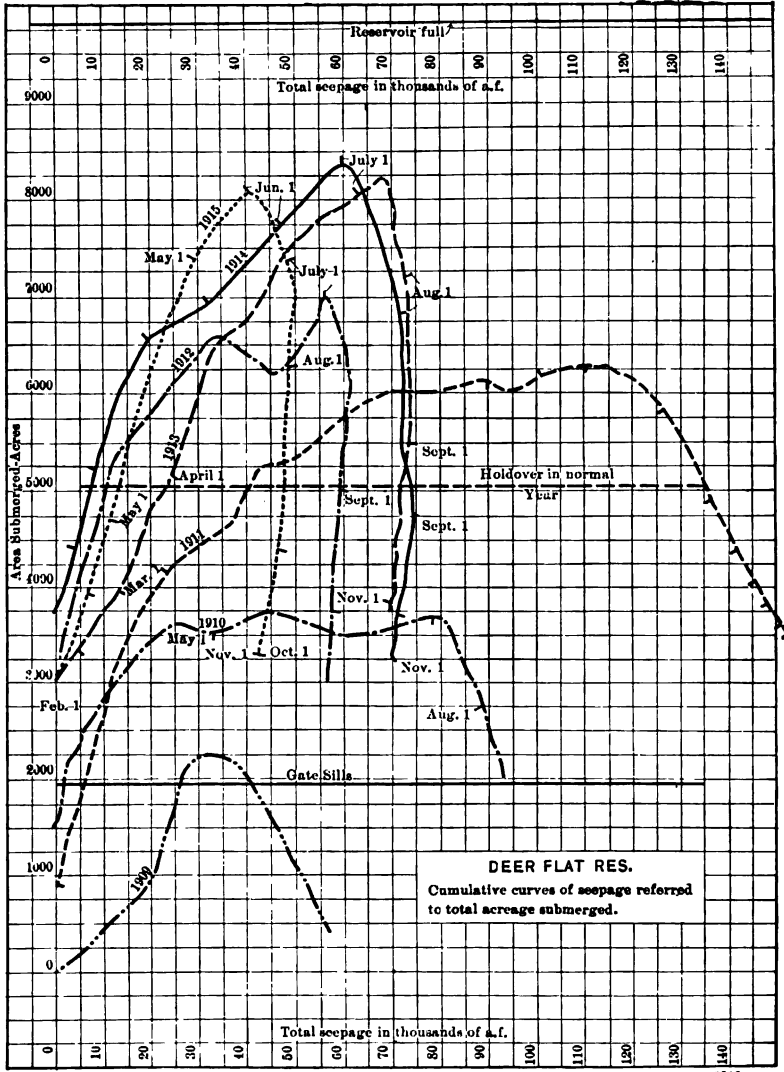

FIG. 167.—Curves of Seepage from Deer Flat Reservoir, Showing the Improvement with Use.

excessive losses, but subsequent service showed rapid improvement, and in 1917 the seepage losses were equivalent to less than 2 tenths of an inch per day, or about equal to the evaporation.

TABLE XXXIII.—DEER FLAT RESERVOIR LOSSES

Year	Mean Acreage Submerged	Maximum Acreage Submerged	Evaporation in Acre-feet	Total Loss in Acre-feet	Seepage Loss in Acre-feet	AVERAGE SEEPAGE LOSS	
						Acre-feet per Acre	Inches per Day
1909	1,355	2,500	4,750	57,600	52,850	39.	1.28
1910	3,002	3,900	10,500	95,483	84,983	28.3	0.93
1911	4,459	6,300	15,600	150,838	135,238	30.3	1.00
1912	4,625	7,000	16,200	85,089	68,889	14.9	0.49
1913	5,250	8,200	18,400	89,489	71,089	13.5	0.44
1914	5,337	8,400	18,700	82,084	63,384	12.0	0.40
1915	5,123	8,100	17,900	67,400	49,500	9.7	0.32
1916	4,820	6,900	16,900	43,970	27,070	5.6	0.18
1917	4,500	7,550	11,000	32,400	21,400	4.8	0.16
Mean..	4,274	6,540	14,440	78,150	63,820		
Total..	38,471	58,850	129,950	704,353	574,403		

The losses during 1909, 1910 and 1911 were less per area submerged than would be expected in a canal in good tight soil, and in the last two years this is reduced to less than what might be expected from a canal with heavy concrete lining. The steady improvement and remarkable tightness attained are due to the filling of the subsoil with water which cannot rapidly escape, and not to any abnormal tightness of the soil.

Lake McMillan.—On the Pecos River, near Carlsbad, New Mexico, is a project originally designed and built by a private corporation, in a region in which the country rock is mainly gypsum, or sulphate of lime, a very soft rock easily eroded by water, and to some extent soluble therein. The main reservoir, Lake McMillan, is formed by a dam across the Pecos River, and the eastern bank of the reservoir is formed by a gypsum bluff. When the reservoir was filled, the water freely entered crevices in this bluff, and found ready escape underground,

away from the reservoir. By erosion and solution these openings steadily enlarged and were cut down to the bed of the river, so that they received and carried away the entire ordinary flow of the stream amounting to several hundred second-feet. Numerous sink holes also appeared in the bottom of the reservoir into which the water escaped in considerable quantities. The main leaks in the gypsum bluff were excluded by building an earth and rock dike parallel to the bluff for a length of about 4000 feet, to a height of 19 feet. The holes in the bottom are puddled from time to time, but not completely cured.

Hondo Reservoir.—In the same valley, near Roswell, N. M., a reservoir was formed by a natural depression which was increased by connecting the surrounding hills by dikes, and water was supplied through a feed canal. Leaks developed soon after the water was turned into the reservoir, and these rapidly increased by the enlargement of holes in the bottom of the basin, which apparently connected with subterranean caverns. Efforts at puddling the leaks were unavailing, and they increased to about 200 cubic feet per second, and the reservoir had to be abandoned.

The country rock in this region is composed largely of gypsum, which is readily eroded and dissolved, and contains water-formed caverns which constitute the seat of the trouble. The depression which forms the reservoir site may be due to the collapse of such caverns. Depressions of this nature are to be regarded with suspicion.

Walnut Canyon Reservoir.—In Walnut Canyon, Arizona, a reservoir was built to store water for railroad uses by the Atchison, Topeka & Santa Fe Railroad Company, but although the dam was tight and the earthen bottom appeared good, the losses have persisted at the rate of more than half a foot per day over the submerged area, and this is sufficient to nearly empty the full reservoir in about seven months, and largely destroys its value. The country rock is sandstone, and evidently has enough seams to carry off the water fast enough to keep the water table down, and keep the seepage in progress in nearly a vertical direction. The rate of seepage is not as great as

generally occurs from a well-built canal in good earth, and much less than a majority of the canals in service, yet it is great enough to destroy most of the benefits expected from this reservoir.

The North Side Twin Falls Irrigation System is built in a country underlain by lava rock through which Snake River flows in a gorge several hundred feet deep. Any crevices in the lava, therefore, have communication with this deep gorge, and water in them can readily escape. Numerous springs are in evidence on the walls of the canyon. The Jerome Reservoir is constructed on this plain, and fed by the Main Canal.

In this reservoir the seepage losses are about 0.85 foot in depth per day, or about what would be expected from a canal in good earth. There are sufficient holes and fissures in the underlying rock so that the seepage waters have ready escape to the Snake River Canyon, and this rate of seepage is therefore permanent and continuous so long as water is in the reservoir. As the area of the reservoir is 4000 acres, the seepage is over 2000 acre-feet per day on an average. This means a loss of over 60,000 acre-feet per month, which is so serious that the reservoir is considered practically worthless.

Many holes developed in the reservoir bottom, usually starting from a badger hole, connecting with a blow hole in the lava, and enlarged until the hole in the lava received all the water it could carry. Most of these holes were less than 6 inches in diameter, but a few were found much larger. The smaller holes generally became clogged with moss and débris, and the rest were dug down to a depth of several feet, and carefully puddled with earth, which usually made a permanent cure of the particular leak. The large loss of water, amounting to 1000 second-feet more or less, was due to the fact that the crevices in the under-lying rock would carry off the water as fast as it could filter through the soil. The absence of any water table, permitting the continuance of the seepage in a vertical direction, was the cause of the reservoir's failure, and this will be true of any reservoir, no matter how good the soil is, if the conditions permit the seepage to travel on vertical rather than nearly horizontal lines.

Tule Lake is a broad shallow lake in Northern California. The basin was formed by a lava flow known as the "Modoc Lava Beds." The lake receives the entire flow of Lost River, which is disposed of by evaporation and leaking through the lava, which is very seamy. The indications are that the water formerly escaped through the crevices in the lava as rapidly as it entered, and that the lake in its present dimensions is of very recent origin, due to the clogging of the seams with drift, grasses, etc.

A combination earth and rockfill dam, built for storage purposes on the Zuni River in New Mexico near an Indian Pueblo of the same name, had for its south abutment a lava-capped mesa, underlain with several strata of sand and clay which were exposed in the margin of the reservoir, and passing under the lava cap, cropped out in the canyon below. When the reservoir was filled, the sand strata leaked to an erosive extent, and soon developed a discharge estimated at 5000 cubic feet per second. This cut away the sand and clay, undermining the hard basalt cap, which fell a distance of 7 to 9 feet.

It is often difficult to recognize in advance the conditions that produce failure of a reservoir from leakage, and where they exist, they appear to be generally irremedial. A few rules of caution may, however, be of use:

1. Avoid reservoir sites adjacent to gypsum deposits and to limestone deposits which show evidence of caves.
2. Reservoir sites in volcanic rock should be carefully examined for the prevalence of seams or cavities.
3. Coarse-grained sandstone should be regarded with suspicion.
4. Natural depressions are often treacherous and should be avoided if near cavernous rock or deep canyons, or are underlain with coarse material where water might readily escape. Under such conditions, no superficial tightness will remedy the trouble.
5. Seams of sand or gravel in the reservoir and out-cropping below, are apt to cause trouble.

5. Survey of Reservoir Sites.—In order to furnish data for comparison, and for estimating the value and cost of contemplated reservoirs, a careful preliminary survey of each is necessary. The catchment basin of each should be accurately outlined and enough topographic information secured to show the general character of the soil and slopes and the runoff result to be expected therefrom. Stream measurements should be started early at such locations as will show the flow available for each site; inquiries of the inhabitants and others, and careful examinations of flood marks should be made to shed all possible light upon the maximum and minimum flow. Some determinations should also be made of the rate of evaporation to be used in each location.

Each reservoir site considered should be surveyed topographically, by means of a plane table. The highest point which the dam may reach should be considered, and the top contour of the corresponding reservoir meandered around the entire site, showing its outlines and total area. A main traverse should be run through the axis or lowest line of the site, terminating at the dam at one end and the top contour at the other. These traverses should be controlled in elevation by careful leveling, and from them enough intersections and stadia locations can usually be made to control the topography of the entire site unless it is timbered, in which case additional traverses may be necessary.

The scale of the survey should be from 1000 feet to an inch for small or medium-sized sites, to 2000 feet to an inch or even smaller scale for very large sites where the map on a large scale would be unwieldy and inconvenient.

The contour interval should be 10 feet for reservoirs with bold mountainous topography, and 5 feet for those of moderate slopes.

When the contour map is completed the area enclosed by each contour should be measured by planimeter, and from these data the capacity for the various depths may be computed, and the results from various heights of dam compared.

In computing the capacity allowance must be made for any

dead space or unavailable capacity below the bottom of the lowest outlet, since the water below this cannot be drawn off. This space, will however, ordinarily fill with sediment in time, as all streams carry some sediment at times, and in some cases the accumulated sediment soon detracts from the capacity of the reservoir and its disposition becomes a serious problem. In general the streams in the upper portions of a drainage basin carry less solid matter in proportion to volume than those in the lower basin, and for this reason reservoirs on the upper reaches may be preferable to those below. This is especially the case with streams in the southwestern portion of the United States, which carry much sediment.

6. Spillway Provisions.—It has been said that the most important feature of an earthen dam is the spillway; and in the sense that it is the essential feature that is most often neglected, this is perhaps true. This is due largely to the extreme uncertainty of the contingency to be provided for, and the certainty of disaster if the water is allowed to overtop the embankment. It is easy to calculate water pressures and allow for them, and the permeability of materials can be tested and controlled. But who can tell the magnitude or manner of occurrence of the largest flood on any stream that the future has in store? Even where a long record is available serious errors are possible.

The floods of 1913 in the Miami Valley swept away structures that had stood unharmed for half a century. Nor is it certain that the flood of 1913 will never be exceeded. The plans adopted for controlling such floods contain provision for a much larger flow.

A board of experts once carefully studied a history of forty years on the Sacramento River and concluded that the greatest flood to be expected there was 80,000 cubic feet per second. A few years after this a flood occurred exceeding 200,000 cubic feet per second at the same point.

The Sweetwater Dam in Southern California was built of masonry with a spillway capacity of 1500 second-feet, which was the estimated discharge of the greatest flood within the

memory of the "oldest inhabitant." A few years after the completion of the dam it was overtopped and much damage done by a flood approaching 18,000 cubic feet per second. The damage was repaired and spillway capacity provided for about 20,000 second-feet. In 1915 this capacity was exceeded and considerable damage resulted that could have been obviated by a larger spillway.

Before the construction of the Cold Springs Dam in Oregon a careful examination was made of the valley for signs of floods, but none were found indicating any considerable overflow of the waterway, the capacity of which was less than 1000 second-feet; yet during the construction of the work, a heavy rain falling on snow caused a flood of over 6000 cubic feet per second.

These examples show the futility of depending on local signs or short records, or even upon fairly long records unless a liberal factor of safety is applied to their indications. It would be indeed marvelous if an available record of ten or twenty years should contain the largest flood of all the centuries.

The floods of 1913 in Ohio and Indiana appear from the evidence to have exceeded by 40 or 50 per cent any that had occurred there for 105 years and to be considerably greater than the next highest in 1805.

In 1827 the Ardèche River in France was visited by a flood much greater than any that has occurred in the succeeding ninety years.

The flood of 1846 in the Loire River in France has not been equaled since that date.

Many illustrations might be cited of the fact that extreme local rainfall or runoff may occur only at long intervals of time but are nevertheless likely to occur. It is necessary, therefore, in estimating extremes to be provided for to consider the extremes observed on areas as nearly similar as possible, and to allow a factor of safety sufficient to eliminate all risks involved in the necessary assumptions, giving due regard to the time and geographic extent covered by the available data.

Comparatively few measurements of great floods have been made. Systematic stream measurements of accuracy are

TABLE XXXIV.—EXCESSIVE RAINFALLS

Station	Elev.	Average Annual	Date	INCHES IN 1 TO 5 DAYS				
				1	2	3	4	5
Lick Observatory.....	4209	32.28	Dec., 1884.....		9.05			
			Jan., 1911.....		*9.19			
Magalia, Cal.....	2320	83.12	Jan., 1906	10.86				
Mono Ranch, Cal.....	3210		Mar. 1906	11.50				
Helen Mine, Cal.....	2750	100.14	Dec., 1913	10.40	14.75	15.47		
Inskip, Cal.....	4975	100†	Dec., 1913	10.35	13.23	14.23		
West Branch, Cal.....	3216	91†	Dec., 1910	10.00	13.60	14.25		
Nellie, Cal.....	5350	44†	Jan., 1916	11.24	17.24	20.76	22.61	23.12
Rialto, Cal.....	2250	69†	Jan., 1916	12.95	15.90	18.79	20.16	20.27
Squirrel Inn, Cal.....	5280	37.22	Jan., 1916	16.81	22.64	25.66	26.87	27.32
Los Gatos, Cal.....	600	33.33	Jan., 1911	6.15	9.95	13.30	16.15	16.31
Needles, Cal.....	427	3.52	July, 1914	3.75				

* Precipitation probably occurred in two or more days.
† Average annual rainfall approximate.

Station	Average Annual	Date	INCHES OF RAINFALL IN				
			1 day	2 days	3 days	4 days	5 days
Monterey, Mexico.....	25.0	Aug., 1913	11.3	15.8	17.6	18.8	21.6
Alexandria, La.....		June, 1886	21.4				
Alapass, N. C.....		July, 1916	22.2				
Montell, Texas.....		Jan., 1913	20.6				
Jamaica.....		Nov., 1909				48	
Hyderabad, India.....	8.0	Aug., 1865	10.2		15.4		
Dorbajee, India.....	40.*	Aug., 1866	20.0	34.0	36.0		
Cherrapanji, India.....		June, 1876	40.8				114.5
Purneah, N. Bengal.....		Sept., 1879	35.0				
Madras, India.....		Oct., 1846	20.6				
Bombay, India.....		June, 1886	16.0				
Calcutta, India.....		May, 1835	12.0				
Himalaya Foothills, India.....			18.0		30.0		
Tabana, Japan.....		Aug., 1899	35.5	50.00			
Sama, Japan.....		Oct., 1893	29.4				
Crohamburst, Queensland.....		Feb., 1893	30.7	50.8	61.6	72.3	
Port Jackson, N. S. W.....		Oct., 1844	20.4				
Sidney, N. S. W.....		May, 1889	8.3				
Windsor, N. S. W.....			12.7				
Newcastle, N. S. W.....		Mar., 1871	10.6				
Delanason, Fiji I.....		Mar., 1871	15.0				
Neydunkeni, Ceylon.....		Dec., 1897	31.8				
Hongkong, China.....		May, 1881	21.8	33.1			
Baguio, P. I.....		July, 1911	35.0	46.0		88.1	
Rio Janeiro, Brazil.....		Apr., 1883	8.8				

* Average annual rainfall approximate.

TABLE XXXIV.—EXCESSIVE RAINFALLS.—Continued.

[Station	Average Annual	Date	INCHES IN 1 TO 5 DAYS				
			1	2	3	4	5
San Francisco, Cal.....		Dec. 19, 1866	7.8				
Philadelphia, Pa.....		Sept. 22, 1882	9.57			
Mayport, Fla.....			13.7				
Jewell, Md.....		July 27, 1897	14.7				
Greytown, Nic.....		Dec. 5, 1892	8.8				
Greytown, Nic.....		Nov. 4, 1899	12.4				
La Boca, C. Z.....		Nov. 17, 1906	7.3				
Culebra, C. Z.....		Dec. 3, 1906	5.6				
Gatun, C. Z.....		Dec. 3, 1906	10.5				
Empire, C. Z.....		Dec. 3, 1906	6.2				
Santiago, Cuba.....		Sept. 3, 1900	10.6	22.2		
Matanzas, Cuba.....		1901	6.9				
Guantanamo, Cuba.....		Oct. 13, 1901	17.5	7.8 in. in 4 hours			
Philadelphia, Pa.....		Aug. 3, 1898	5.4	3 in. in 2 hours.			
Boston, Mass.....		Aug. 22, 1899,	2.05 in. in 1 hour.				
Concord, Penn.....		Aug., 1843,	16 in. in 3 hours.				
Guinea, Va.....		Aug., 1906,	9.3 in. in 1 hour.				
Galveston, Texas.....		June, 1871,	3.9 in. in 14 hours.				
Ft. McPherson, Neb.....		May, 1868,	1.5 in. in 5 hours.				
Sydney, N. S. W.....		Feb. 11, 1894,	3 in. in 30 minutes.				
Himalaya Foothills, India.....			700 in. in 1 year.				

mostly of recent origin and the points of measurement are still comparatively few, and it has frequently happened that the really destructive floods have destroyed the facilities for measurement, and the extremely rare opportunities for measuring great floods are thereby sometimes lost.

On the other hand, rainfall measurements are far more widely distributed, have been continued for a much longer period, and in general may be regarded as more reliable than flood measurements of streams, on account of their greater simplicity.

For these reasons we are often compelled to rely more upon rainfall records than upon measurements of runoff for estimating the magnitude of floods for which we must provide spillway capacity.

A study of the longest available rainfall records shows that it is possible here and there to select consecutive periods of a

half century or so which contain no excessive precipitation approaching that shown by other parts of the same record. It is seldom, however, that a period is found in which the maximum of 1000 years exceeds very much that shown by any period of 100 or 200 years.

Professor Kuichling has compiled and published a list of high discharges from which the most extreme floods have been selected and condensed into a table along with other data, which are given in the last chapter of this book.

7. Outlet Works.—One of the most vulnerable features of an earthen dam is the provision for drawing water from the reservoir through or past the dam. The danger consists in the fact that unless elaborate precautions are taken, the conduit presents a convenient path for the percolation of water, which may carry earth with it, and gradually enlarge the opening until a breach is made and the dam destroyed.

The outlet conduit is generally of concrete although cast-iron pipe is sometimes used for small reservoirs. In a few cases wooden conduits have been provided, but this is bad practice, as any decay at once opens passage for leakage.

It is best to locate the conduit in an open trench cut in rock, hardpan or clay, and to build the concrete directly against the sides and bottom of the trench, which will thus form a good bond between the artificial work and the natural ground. The trench above the conduit should be filled with selected material carefully puddled and rammed in place. The conduit should be provided with wide collars or diaphragms of concrete, extending entirely around the circumference, and these should also be built against the natural material in place as far as possible. The collars may be of any convenient thickness, as 1 or 2 feet, and should extend into the foundation and the fill at least 3 feet beyond the outer lines of the conduit proper. The masonry in contact with the natural and filled material should be rough and corrugated and every precaution taken to form a tight bond between them, as this is one of the most difficult as well as the most important problems in connection with earth dam construction.

The valves controlling the admission of water to the conduit should be placed at the upper end, at or near the upstream toe of the embankment, and some means should be provided by which access may be had to the valves at any time that they might need attention.

This position of the valves, if ordinary valves are used, requires a tower built over them at a distance from the crest of the dam, which must be reached by means of a bridge. The bridge could be avoided and the tower much cheapened by placing the valves near the axis of the dam, but this is objectionable, as it would admit water to half the conduit under pressure of the full head in the reservoir, and any leaks would introduce water into the heart of the dam, and might in time cause saturation and softening of the interior of the dam and give rise to danger that might otherwise be avoided. The controlling valves may be of the balanced type controlled by water pressure as described on p. 365. The pipe controlling the leakage which governs the position of the valve may be led through the conduit or up the slope of the dam, and thus avoid building a tower in the reservoir for control purposes. Such a control is in successful use on the Owl Creek Dam in South Dakota.

Slide valves may be installed on the upper end of the conduit at the toe of the dam, placed in the plane of the water slope of the dam, sliding in grooves and attached to gate stems following up the slope to the top of the dam, where they are controlled by gate stands on top of the dam. This type of control does not always give satisfaction. The stem following the slope of the dam is long and requires a number of supports to hold it in line. These are placed on the earth fill and are subject to unequal settlement, and unless protected, to the attacks of ice, of drift and of waves. It is not surprising that they often get out of line and become difficult to operate.

A successful valve of this type is in use on the Conconully reservoir of the Okanogan project in Washington, which is closed by an earth dam 83 feet high. The outlet is a circular conduit of reinforced concrete 4 feet 6 inches inside diameter. This is controlled by a cast-iron valve gate 3 feet 6 inches in diameter,

placed in a gate-well 7 feet square for access, and operated from a gate house 62 feet above by a steel shaft and geared wheel. This shaft is supported in an inclined tunnel 5 feet 10 inches in section and 103 feet in length, the reinforced concrete walls of which are from 15 to 24 inches in thickness (Fig. 168).

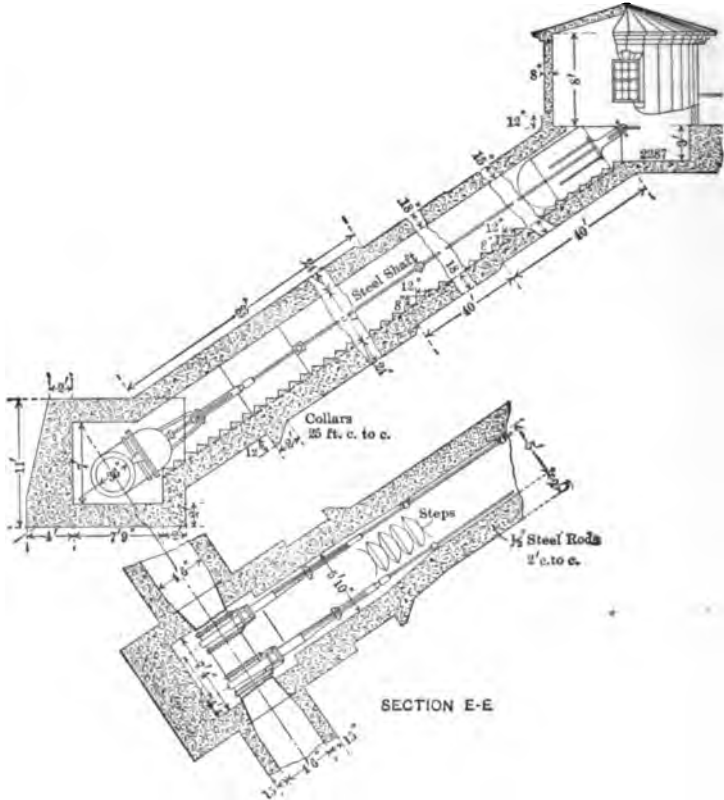

FIG. 168.—Gate House, Conconully Dam, Wash.

If the Ensign type of balanced valve be used, see Fig. 172, the control pipe may pass through the conduit, and thus be thoroughly protected, and does not require any special alinement. The balanced valve moving with little friction is less likely to get out of order or require attention than ordinary slide valves.

A simple outlet gate (Fig. 169), designed by Mr. J. D. Schuyler to be built on the face of Fay reservoir dam, is adapted

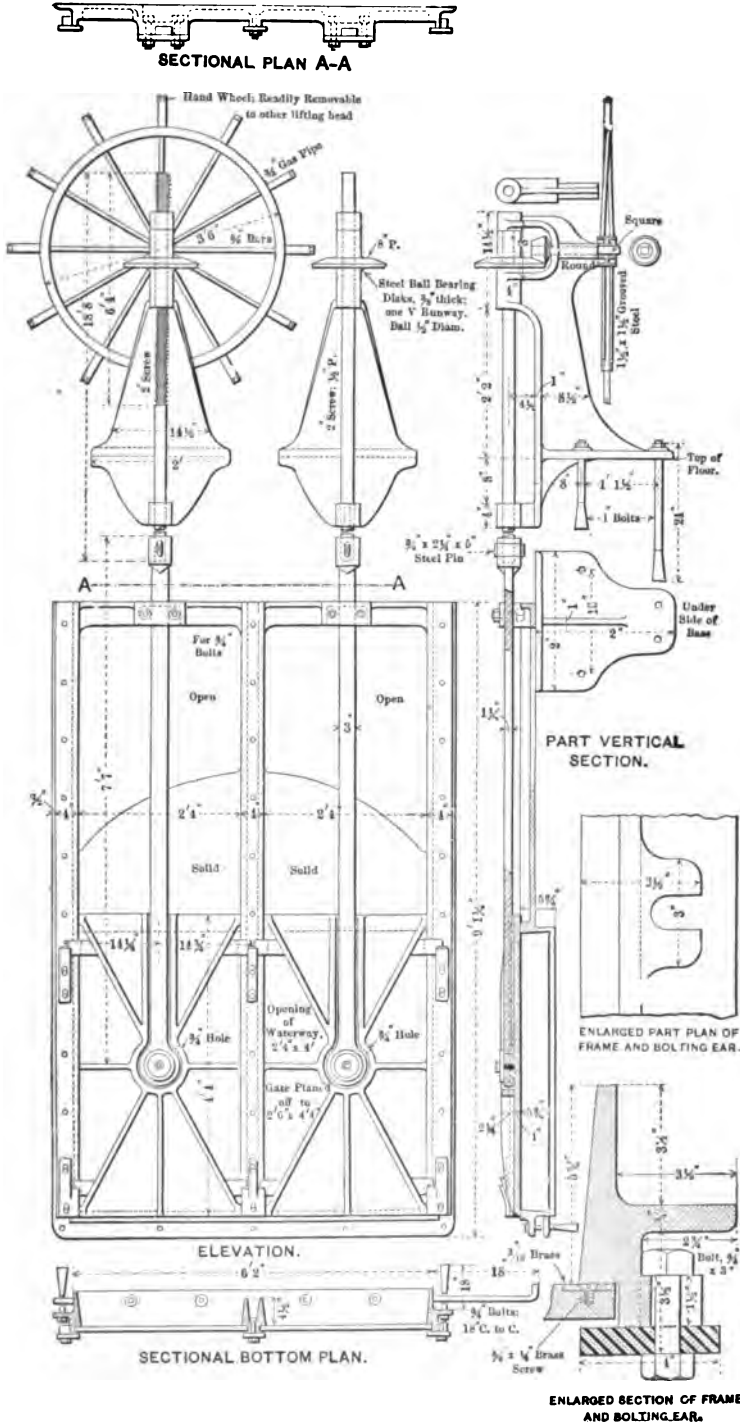

FIG. 169.—Vertical Lift Outlet Gate, Fay Lake Reservoir, Arizona.

to closing an outlet of either circular or rectangular form. The gate is hung on its center by one heavy lug, over which the stem is placed, expanded to the form of a flat eye-bolt, having sufficient play to enable the gate to accommodate itself to its seat freely, to which it is forced by inclined planes on six lugs and guides. The frame of the hoisting apparatus rests on top of the masonry, to which it is anchored, and the nut and beveled gear are of hard brass. Ball bearings are fitted under the nut, and a light capstan wheel takes the place of the ordinary crank, rendering the gate easily handled under the maximum head of 25 feet.

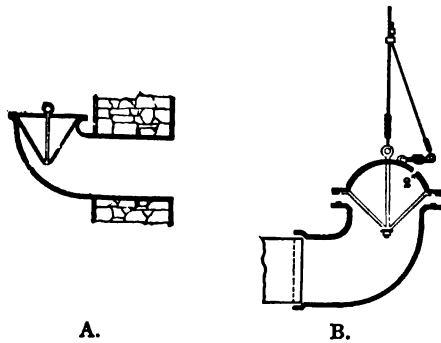

FIG. 170.—Valve-plugs, *A*, Sweetwater, and *B*, Hemet Dams.

Two other very simple devices designed by the same engineer are illustrated in Fig. 170. Each of these consists of a simple cast-iron plug let into the top of the pipe, the end of which is bent upward to receive it. The plug is held in position by the pressure of water, and is opened by a chain operated from above by a windlass.

Butterfly and Needle Valves.—One of the safest and most satisfactory forms of outlet for delivering water through an earthen dam is that in use at the Minitare Dam of the U. S. Reclamation Service, in North Platte Valley, Nebraska. It consists of a concrete tube with arched top and invert, built in cut averaging somewhat less than the height of the tube, or about 8 feet, with cut-off collars at frequent intervals on the outside to check percolation along the tube. Inside this tube

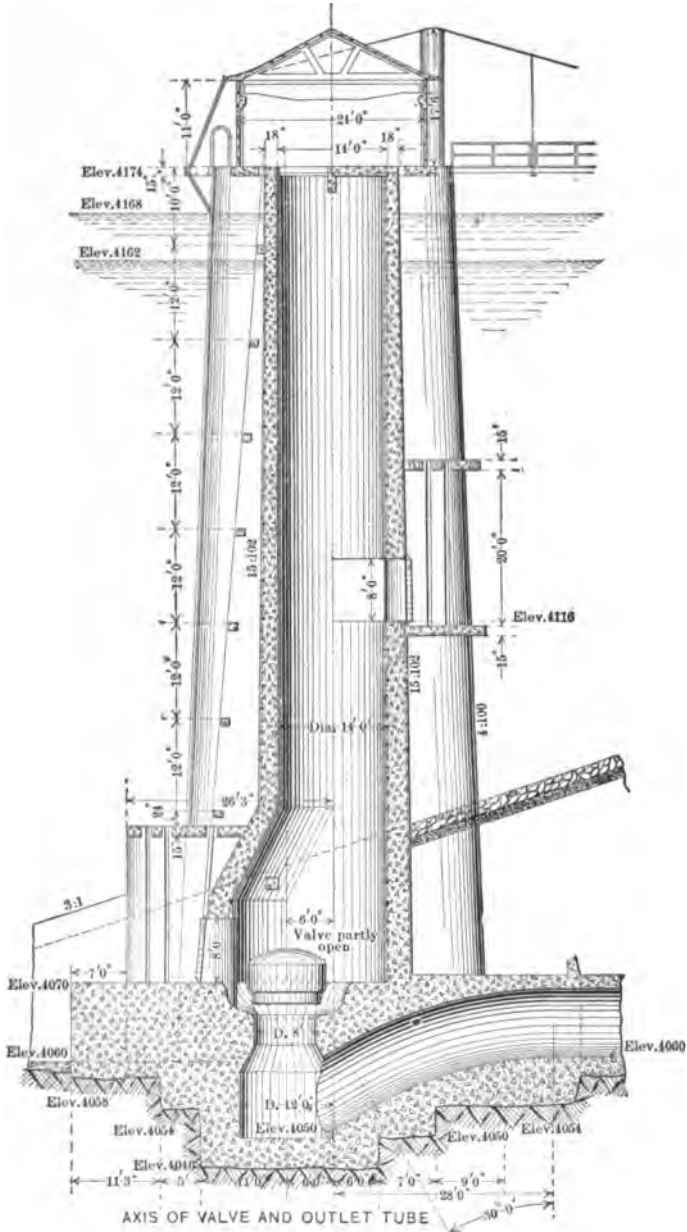

FIG. 171.—Outlet Works, Lahontan Dam, Carson River, Nevada.

are laid side by side two heavy steel pipes, each 30 inches in diameter, with their upper ends projecting through a heavy concrete bulkhead into the reservoir. Just back of this bulkhead each pipe is equipped with a butterfly valve, which being approximately balanced, is easily operated under full head, and is used as an emergency valve. Its operating chamber is an enlargement of the concrete tube. The service valves are installed at the downstream ends of the pipes, and are of the needle valve type, similar in design to that shown on p. 368.

The tunnel is drained at the lower end, and room is afforded for careful inspection of the pipes throughout.

In this arrangement there is no opportunity for water to escape by leakage into the interior of the dam, any leakage of pipes being led away by the drainage of the tunnel, and being also accessible for repair.

Although the butterfly valves cannot be made entirely tight under high heads, they can be made nearly so if carefully installed, and being simple and seldom operated are not likely to get out of order. By closing one of them, the needle valve on the lower end of the same pipe may be taken apart and repaired at any time, even while the other needle valve is discharging water. No gate tower in the reservoir is necessary with its menace from ice and waves. Altogether this is regarded as the most satisfactory regulating system connected with an earthen dam yet tried.

Balanced Piston Valve.—A type of valve used on several of the reservoirs of the Reclamation Service, Fig. 172, has shown especial suitability for use where it is necessary to draw large quantities of water under high heads. It utilizes the enormous water pressures to open and close the valve. It consists of a steel cylinder closed at the outer or downstream end, in which slides a piston, the inner end of which forms a needle, operating to regulate the amount of water discharged and closing like a check valve. The piston may be removed by removing the cylinder head. It is kept in alinement with the axis of the cylinder by bronze guides.

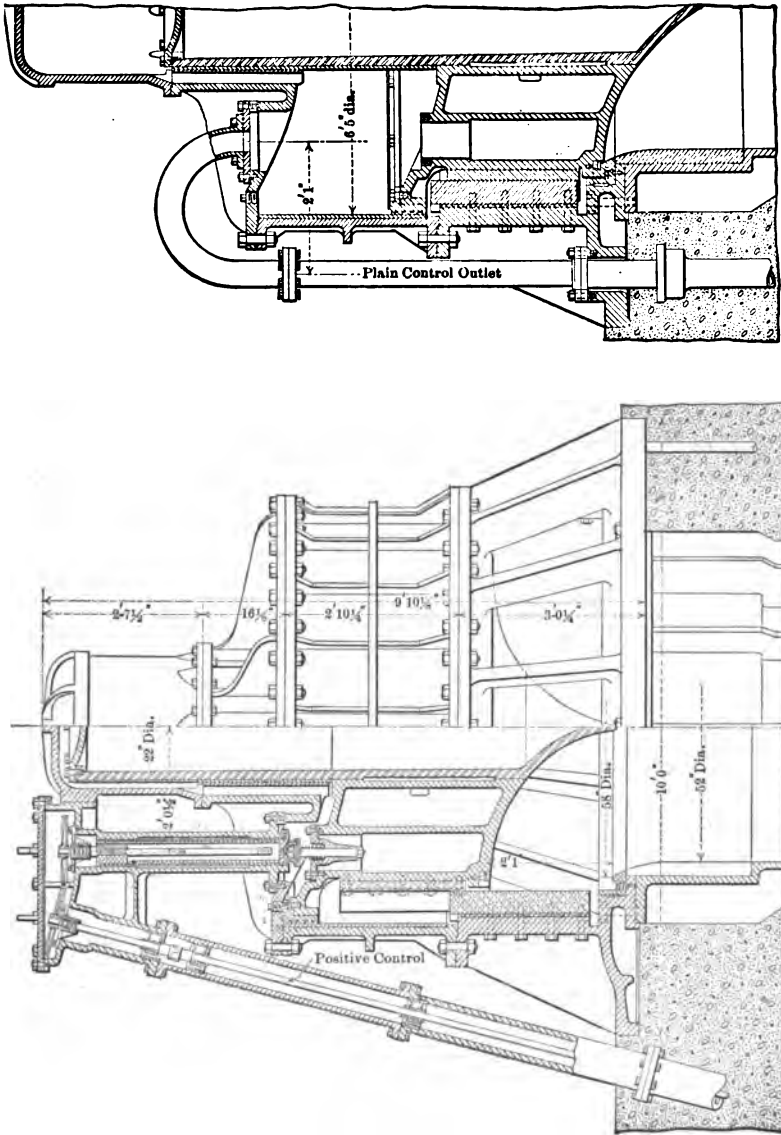

FIG. 172.—Section of Balanced Valve, Arrowrock Dam, Boise River, Idaho.



FIG. 173.—Outlet Conduit, Keechelur Dam, Washington, Showing Concrete Cut-off Collars, Corewall and Track for Backfilling on Left.



FIG. 174.—Butterfly Valve, Minitare Dam, Nebraska.

It is opened and closed by the regulation of the pressure of water behind the main piston, the pressure being supplied by the restricted leak past the piston, and relieved by a drain or control pipe leading out from the cylinder head. To open the valve the pressure on the piston is reduced by opening the outlet of the

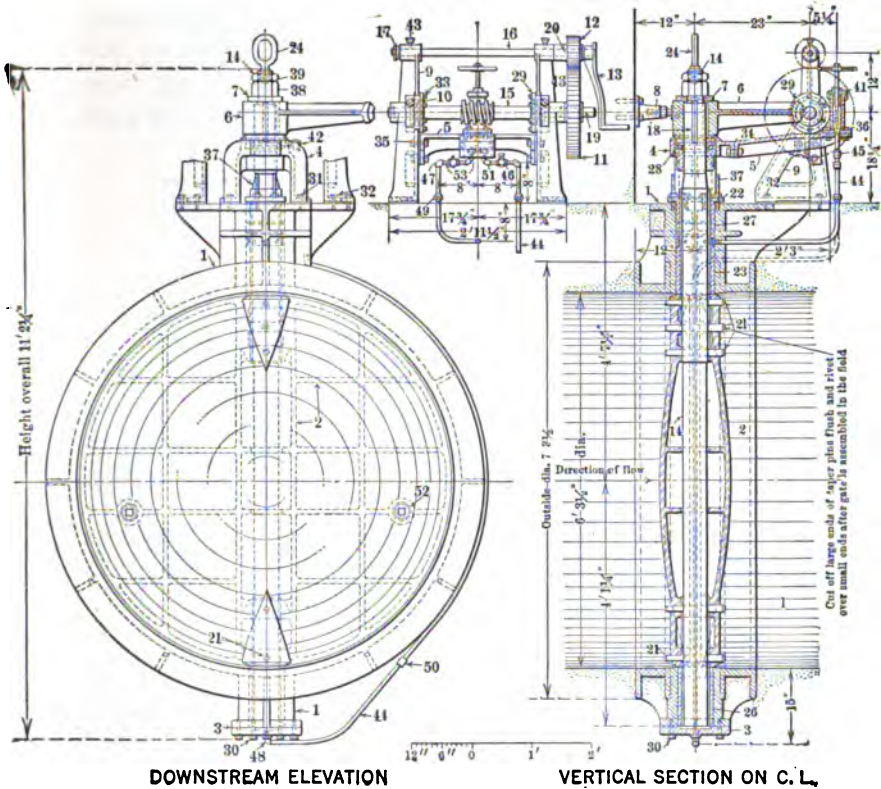

FIG. 175.—Elevation and Section of Butterfly Valve.

control pipe. As long as this discharges freely the valve will continue to move until completely open, and it may be stopped at any point partially open by properly regulating the leakage through the control pipe. To close the valve, the outlet from the control pipe is closed and pressure applied from a tank far above the reservoir to start the piston, after which it will slowly

close itself, the rate of movement depending on the volume of leakage around the piston.

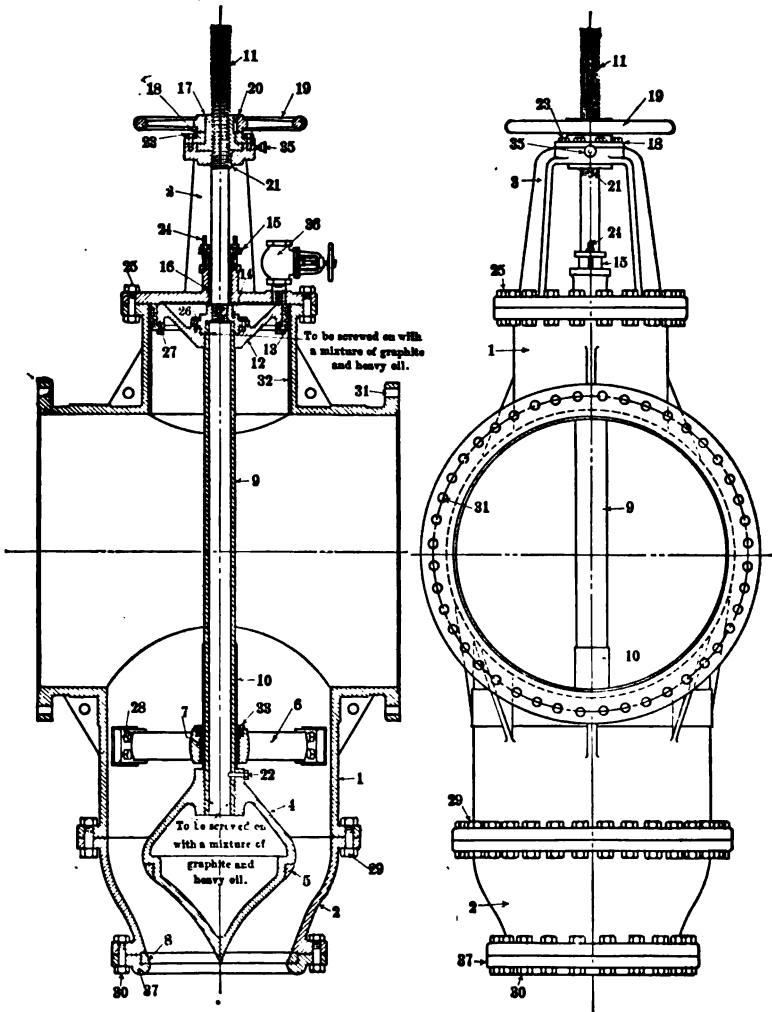

FIG. 176.—Needle Valve in Outlet Conduit, Minitare Dam, North Platte Valley, Nebraska.

In order to give positive and accurate regulation of discharge from the reservoir a positive control is also provided as shown

in the drawing. The leakage is regulated by a movable sleeve fitting over a conical seat which stops the leakage when closed and when opened permits the escape of water, thus removing the pressure from that side of the piston, causing the valve to open. The valve thus follows the sleeve, maintaining just enough area between the sleeve and the conical seat to regulate the leakage to the quantity required for balance. The sleeve being movable at will, by means of a hand-wheel, rod and screw, the position of the valve can be accurately controlled. An indicator is provided to show the position of the valve at any time.

CHAPTER XVI

SEDIMENTATION OF RESERVOIRS

ALL natural streams erode their channels to some extent, and carry more or less silt in suspension and roll along their bottoms sand and gravel. Where a dam is built across the stream and the water impounded, the sediment settles, and may in time seriously impair the reservoir capacity if not removed. In high mountainous regions where the slopes are protected from erosion by forests, and where the water comes chiefly from springs or melting snows, the streams are usually clear and very little sediment is carried. On such streams the silt problem is generally considered negligible or so far in the future as to be met by constructing new reservoirs when needed. Lower down the same stream may accumulate more sediment, and this problem may assume considerable importance.

In other regions less protected by vegetation and subject to torrential rains, as in the southwestern part of the United States, the streams carry enormous quantities of solid matter, and it becomes a serious question whether any given storage project is feasible in view of the rapidity with which the capacity will be destroyed by filling with detritus. The Colorado and the Rio Grande are typical streams of this class.

Where it is feasible to locate the reservoir off the stream, and conduct the water to it through a feed canal, it may be possible to discard most of the coarse material by means of settling basins and scouring sluices, but these require much attention, waste much water and are not very effective in eliminating the finer silt.

The problem involved by the sedimentation of reservoirs constructed on silt-bearing streams is one which has received

much study, and various theories have been advanced for its solution, but none of them have been proved out in practice.

Several efforts have been made to determine a reliable factor to express the relation between the dry weight of silt obtained by observation, and the volume of the same silt as it would lie in the bottom of a reservoir, the question being, "What is the dry weight of a cubic foot of silt deposited in a large reservoir by sedimentation of the flood waters of the stream?"

The following table shows the results of the four most reliable of these attempts:

TABLE XXXV

Observer	Weight of Cubic Foot of Wet Deposited Silt	Dry Weight	Specific Gravity
Follett.....	53.0	
Coghlan.....	104.7	92.3	2.64
Hughes.....	89.5	76.1	2.55
Lawson.....	86.0	2.60

Averaging the above results, we have 77 pounds as the average dry weight of a cubic foot of silt deposited in a reservoir. This however, can be taken as only a very rough guide, as would be inferred from the wide discrepancy in the results quoted.

The variation is doubtless due in part to actual difference in character and weight of the different samples of silt tested. It is probable that a more important reason is the difference in judgment of the different observers as to what constitutes a sample of silt representative of conditions in the bottom of a large reservoir, under the pressure of overlying mud and water. Such conditions will vary widely, and we cannot hope to obtain any results that would serve as more than a rough guide for future estimates.

Systematic observations of silt carried in suspension by the waters of the Rio Grande have been made by the United States Government, from 1897 to the present time. These observations up to and including 1912 were carefully studied by W. W. Follett and the results obtained are summarized in the following table:

TABLE XXXVI.—SILT IN RIO GRANDE PASSING SAN MARCIAL, N. M.

Year	Acre-feet Water	Per Cent Silt	Acre-feet Silt
1897	2,215,953	1.72	38,051
1898	960,981	1.55	14,858
1899	239,434	2.14	5,127
1900	467,703	2.02	9,459
1901	656,252	2.82	18,503
1902	200,729	3.05	6,123
1903	1,272,069	0.97	12,319
1904	709,796	2.37	16,838
1905	2,422,008	0.78	18,875
1906	1,563,737	0.89	13,901
1907	2,157,709	1.11	23,889
1908	774,109	2.00	15,469
1909	1,279,934	1.51	19,318
1910	852,692	0.76	6,520
1911	1,799,733	4.14	74,563
1912	1,499,614	1.47	22,018
Total.....	19,072,453	315,832
Mean.....	1,192,028	1.66	19,739

These silt determinations were made by taking samples of the muddy water as found flowing in the river, and removing the silt by settlement and filtration, drying at 60° C. and weighing it. The percentages are by volume, and are based upon a dry weight of 53 pounds for a cubic foot of wet sediment in place in the reservoir.

This factor of 53 was found by taking the dry weight of a 3-inch cube of wet silt from a slough where a body of flood water had stood until the sediment settled, the water evaporated, and the silt began to shrink from the drying process.

These observations show that if a reservoir of 300,000 acre-feet capacity had been constructed in 1897, it would have been practically filled with sediment several years ago, unless this had been somehow removed. They show, further, that any reservoir constructed on this stream would, unless prevented, have its capacity seriously impaired in a time so short as to present a problem of importance. This must be solved before

deciding upon the construction of an expensive storage project, where thousands of homes are to be established through its agency which will be destroyed if it fails of its purpose.

The measurement of sediment in the Colorado, Gila and Pecos Rivers reveal similar problems concerning storage projects thereon, and the same may be said in some degree of many other streams in this and other countries.

A study of scattered observations of silt carried by the Gila River made by D. E. Hughes,* leads him to the conclusion that its water carries an average of 1.3 per cent of its volume of solid matter.

Various reservoirs in Europe, Asia and America have had their capacity largely destroyed by the accumulation of mud and sand.

From a consideration of all available results of experiment in India and America, Etcheverry concludes that:

1. One cubic foot of saturated silt settled in a tube for one year, contains about 30 pounds of dry silt. The per cent by volume, of saturated silt is equal to the per cent by weight multiplied by 2.1.

2. One cubic foot of moist silt, as deposited under natural conditions in a river or canal or on a field, will contain about 50 pounds of dry silt. For this condition the per cent by volume of moist silt is equal to the per cent by weight multiplied by 1.2.

3. One cubic foot of dried silt will weigh about 90 pounds.

The above results cannot be considered accurate for any particular silt sample, nor for any particular stream, as individual cases vary widely. It is, however, about as good a statement of averages as present knowledge will afford.

2. **Sediment Rolled along the Bottom.**—In addition to the sediment which is held in suspension and carried by the current of the stream there may be larger and heavier particles of sand which are too heavy to be held in suspension but which under the influence of flowing water gradually move downstream along the bottom. This frequently happens in streams of perfectly clear water, and careful observations of such streams will

* House Doc. 791, 63d Congress, 2d Session.

show the sand in small knolls or dunes on the bottom of the stream. The grains of sand on the surface gradually move down the stream. The small sand bars are usually very gentle in slope on the upstream side and steep on the downstream side. The moving grains of sand are carried slowly up the slope of the little bar or dune and reaching the summit are dropped on the downstream side, forming on that side a slope usually about 45 degrees near the top, flattening slowly toward the bottom, while the slope on the upstream side may be 5 or 6 to 1.

Where the major portion of the solid matter carried by the stream is in the form of sand this material moving on the bottom becomes an important element in measuring total solids. Where the eroded material is mainly clay the amount of sediment on the bottom may be insignificant. The quantity of all material carried can, of course, be accurately measured by impounding it, but aside from this method little effort has been made to measure this in flowing streams. The only attempt of this kind on any large scale was that made by the Nicaragua Canal Commission in 1898 upon the streams in Nicaragua in connection with the investigation of an inter-oceanic canal. The method devised was as follows:

A galvanized sheet-iron pan was provided (see Fig. 177), 1 meter square and 8 inches deep, with one side hinged so that it could be opened to lie in the same plane as the bottom of the pan, and a weight and stays were provided to hold it in this horizontal position. Four chains, attached one to each corner of the top of the pan, met about 4 feet above the pan, and united in a ring, and the whole was suspended from a cable stretched across the river, with the door open upstream. An anchor was thrown about 100 feet upstream to hold the pan firmly in position, while it was gently lowered from the cable by means of a rope from shore, working in tackle blocks. The pan was allowed to settle firmly on the bottom, and to remain for a limited time, usually one hour. The attempt is to cause the minimum disturbance of natural conditions in the stream, and to intercept and hold in the pan the sediment traveling along

the bottom in the section it occupies. When it is desired to close the observation, a small copper wire which has been fastened to the open door and passed through the ring above the pan, is stoutly pulled until it raises the lid from the bottom of the stream, whereupon the current catches and slams the lid shut, where it is automatically fastened by a latch on each side. Then, by means of a windlass on shore, the pan is hoisted and brought to land, and the entrapped sediment measured.

There is nothing about this operation to increase the motion of sediment along the bottom into the pan, so it is thought that

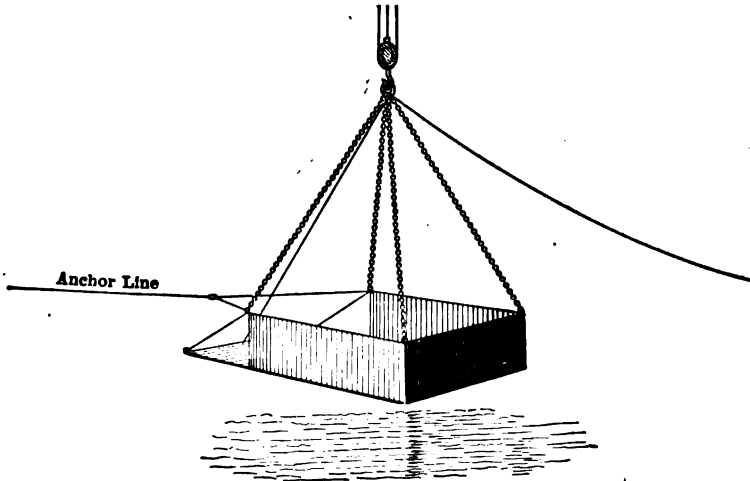

FIG. 177.—Trap for Measuring Sand Rolling on Bottom of Stream.

results can never be too large. On the other hand some sand may pass under the edge of the lid, when the bottom of the river at this point is marred with local inequalities. This is supposed to be one cause of the small results on certain days, when other observations immediately before or after, give large results. Another persistent source of error of unknown magnitude is the washing out of the sediment by the current over the weir formed by the back of the pan. To test the importance of this theoretical possibility, a temporary partition was placed in the pan, perpendicular to the current, and nearly as high as the

sides of the pan, the theory being that if all sediment were stopped by the partition and deposited in front of it, that would be good evidence that in the absence of the partition all would be stopped by the back of the pan, and none lost. In the first experiment more sediment was deposited behind than in front of the partition, and the quantity that passed out of the pan is unknown. This result was essentially repeated for most of the experiments, showing conclusively that more or less sediment is carried out over the back of the pan by the scour which it occasions. It is important to bear this fact in mind, when studying the results, for it is certain that the results are quantitatively too small, and should be regarded as showing that large quantities of sediment are traveling on the bed of the stream, and as roughly indicating the relative amount.

3. Removal of Silt from Reservoirs.—The great Assuan Dam in Egypt, forms a reservoir on the Nile, which has a very large discharge and carries great volumes of silt. The large capacity of the reservoir is formed mainly by the very slight slope of the river, so that the dam causes slack water for a distance of over 40 miles up the river, making a long narrow reservoir, with no very wide valley submerged. The dam is provided with 180 large sluices, and during the rising flood each year, when the river is carrying most sediment, the sluices are left open, and the rushing torrent carries its load through the reservoir and also scours out a portion of the sediment deposited the previous year. As the flood declines in volume it carries less sediment, and the sluice gates are then closed and the waters stored. The sediment deposited during the storage period is largely washed out by the first part of the next year's flood.

This program seems to be effective in preserving sufficient storage capacity for present needs of irrigation, but it requires the waste of the major portion of the water supply in normal years, and also depends upon the extremely long narrow reservoir, in which a swiftly flowing stream is very effective in cutting out the deposited sediment. The variations of flow of the Nile are, moreover, so regular that a predetermined program is possible, which would be utterly impossible upon many streams.

This combination of conditions is so rare that the solution adopted has little application to most cases, and presents no general solution for the problem in hand.

According to Table XXXVI, waters of the Rio Grande during the 16 years carried $1\frac{2}{3}$ per cent of their volume of sediment on an average. The detailed observations from which this summary was compiled show several monthly averages in excess of 10 per cent, and in general the percentage fluctuated widely, but the heaviest percentages are found in the four months of July, August, September and October, and especially August and September. These are the months when the sudden torrential rains occur, and this accounts for the large percentage of sediment in those months; but a greater portion of the water is discharged in April, May and June, while the snows in the mountains are melting, and though the percentage of sediment is less in those months, the total quantity is often greater, due to the greater quantity of water flowing. The flow in the late summer is very unreliable, and it is necessary to meet irrigation needs by storage to be drawn upon at that time, and it is therefore impracticable to apply the methods in use on the Nile, of allowing the muddiest water to flow through the sluice gates unchecked by the reservoir. That method is also impracticable for the further reason that usually all the water is needed for irrigation, and must be stored for that use.

The figures show an accumulation of sediment so rapid that unless we can provide some means of disposing of it and of preserving the storage capacity, it would be unwise to construct the reservoir and build the homes that must depend upon it, as without reliable storage they must be abandoned.

The method proposed as feasible for solving this problem on the Rio Grande is applicable to many other streams, and a description of it may therefore be of value here. It is recognized that to excavate the mud from the reservoir and transport it to locations outside of the reservoir by ordinary mechanical methods would be very expensive, and at present values prohibitive. Even if it could be accomplished at a price of 5 cents per cubic yard, that would amount to about \$80 per acre-foot, whereas

the cost of constructing the reservoir was about \$2 per acre-foot, and an enlargement of 50 per cent can probably be accomplished at about the same rate.

Therefore, as a first step in the solution of the silt problem it was decided to construct a reservoir of nearly twice the capacity absolutely needed to control the flow of the river, so that the accumulations of sediment will not seriously encroach upon the necessary storage capacity for a period of perhaps 40 to 50 years. At that time the works will have been long paid for, and the development of the valley will be such that an enlargement can easily be made which will furnish storage capacity sufficient for another period of 40 or 50 years. The reservoir thus formed will be over 50 miles long, and will not be very wide at any point.

On the headwaters of the stream and its tributaries are several smaller reservoir sites, capable of development to the amount of several hundred thousand acre-feet at moderate cost, which are fed by melting snows and will fill with water carrying very little sediment. Whenever the reservoir at Elephant Butte is so far filled with mud that additional storage is needed, one or more of the mountain reservoirs can be built, and the necessary storage capacity thus provided.

In the management of the storage works it would be the policy to hold the mountain reservoir full of water as long as possible, and draw on the lower reservoir for needed water as long as any water remains there to be drawn. When the lower reservoir becomes empty, the natural flow of the river, reinforced if required, by water from the upper reservoir, would flow through the sea of mud accumulated in the lower reservoir, and cut a channel therein, carrying the mud thus eroded out of the reservoir through the open gates as the water is needed for irrigation. Such a channel extending 50 miles through the axis of the reservoir varying in depth from 240 feet at the dam to zero at the head of the reservoir, and having a bottom width of 250 feet, and side slopes of 3 to 1 would itself have a volume of over 500,000 acre-feet. All the water flowing through the reservoir, both natural flow and stored, would carry from 10

to 15 per cent of its volume of mud until such a channel was cut, and nearly as much for a long time after, by cutting the banks of the channel, and because of their natural tendency to slide and to slough.

In this way, an equilibrium could be established, by which the amount of sediment flowing in annually would be offset by the average amount annually discharged as above. Just how much mountain storage would be necessary to accomplish this could be established only by experience, but until such equilibrium is established the needs of storage would be supplied by building reservoirs, which is cheaper than mechanical removal of silt, provided good reservoir sites exist, as they do in the basin of the Rio Grande.

It will be seen that the application of such a remedy depends upon the topographic and hydrographic characteristics of the drainage basin, including the shape of the reservoir, a long narrow and deep reservoir being most favorable. These conditions would not be found in every case, and each problem would require special consideration.

A method of handling the silt in the Elephant Butte Reservoir proposed by W. W. Follett, is as follows:

About halfway between the dam and the head of the reservoir, in a gorge that occurs at that point, it was proposed to build a dam 40 or 50 feet high, forming a small reservoir within the main large reservoir. On this dam provide a gate tower, extending above the flow line of the reservoir. The gates controlled from this tower were to open into a conduit through this small dam, which would pass on down the valley as a large pipe, to and through the main reservoir dam. This conduit was to be used to draw water from the reservoir whenever possible.

During low stages of the main reservoir the small reservoir formed by the small dam would receive the water of the river, and much of the sediment would be deposited therein before the water passed over its spillway into the main reservoir below. At such times as the small reservoir was low, the turbid natural flow of the river would pass through the conduit, cutting out any silt deposited in the small reservoir, carry its load of fertile

sediment to the irrigated lands, and any additional water required would be drawn from the main reservoir.

This provision would surely have provided muddy water for irrigation much of the time, instead of the clear water now uniformly furnished, and while this would not have prevented the encroachment of sedimentation upon the storage room, it would have retarded it. Its greatest recommendation, however, is that it would have preserved the fertilizing qualities of the irrigation water and thereby increased the fertility of the lands.

This plan was carefully considered by a board of engineers and rejected mainly on account of its cost.

REFERENCES FOR CHAPTERS XV AND XVI

- STRANGE, W. L. Indian Storage Reservoirs. Spon & Chamberlain, New York. Report of Special Committee on Flood Prevention. Trans. Am. Soc. C. E., vol. 81, p. 1218.
- DAVIS, ARTHUR P. Irrigation Works Constructed by the United States. John Wiley & Sons, New York.
- SCHUYLER, J. D. Reservoirs for Irrigation, Water Power and Domestic Water Supply. John Wiley & Sons, New York.
- FLINN, A. D. Rainfall, Runoff and Development of Croton Watershed. *Engineering News*, Feb. 6, 1908.
- DAVIS, ARTHUR P. Water Storage on Salt River. W. S. P. 73, U. S. Geological Survey.
- LIPPINCOTT, J. B. Water Storage on Gila River. W. S. P. 33, U. S. Geological Survey.
- FOLLETT, W. W. Silt in Rio Grande. *Engineering News*, Jan. 15, 1914.
- HUGHES, D. E. San Carlos Irrigation Project. House Doc. 791, 63d Congress, 2d Session.
- Davis, Arthur P., Report on Hydrography of Nicaragua, 1899.

CHAPTER XVII

DAMS

A **DAM** is a structure placed across a stream or gap to obstruct or confine water. When designed to permit water to flow over the top, it is called a weir. In such a case it must be built of such material as will resist a tendency to wash away by the flow of water. This may be either masonry, steel, or some form of wood.

1. Conditions of Safety.—All dams, of whatever magnitude or type, must fulfill certain essential conditions for safety.

1. They must have practically impervious foundations and abutments sufficiently stable to sustain the stresses to which they will be submitted.

2. They must be safe against sliding either on foundation or on any internal joint.

3. They must be safe against overturning.

4. They must be practically impervious, and have water-tight connections with their foundations and abutments.

With respect to their functions, dams may be divided into two classes:

1. Diversion dams.

2. Storage dams.

A diversion dam is one intended only for raising the surface of the water to such height as required for diverting the flow of the stream into a canal or penstock, for power, irrigation or other purposes. The great majority of them are very low, raising the water only a few feet, and intended mainly to provide a permanent sill or crest at the proper elevation instead of a shifting, fluctuating channel. Some diversion dams, however, are as high as 200 feet, and these are often used also partially for storage purposes.

Storage dams are those intended to form reservoirs to store water at times when it is flowing at greater volume than needed for use, and to hold it until so required. Most of the high dams in existence are intended for storage purposes, and in general they are built higher than those intended only for diversion.

2. Diversion Dams or Weirs.—Most dams intended only for diversion purposes are of the weir or overfall type, designed to permit water to flow over the top, on account of the expense of providing safe means of flow elsewhere for the floods. For such use they are generally built of wood or concrete so as to resist the erosion of the flowing water.

a. Timber Dams.—The earliest dams were built by beavers, and were composed of small logs and brush. These have been improved upon by man, by adding large rocks and rude piling to hold the brush in place. Such rude dams were general in the early stages of irrigation, and were employed even in fairly large streams, not to raise the water, but to divert it into a canal built at about the same elevation as the river bed. Such dams were often breached and sometimes entirely destroyed by floods in the stream, thus depriving the canal of water after the subsidence of the flood until it could be replaced, to be again destroyed perhaps after a short time.

One of the earliest types of such structures was the so-called "burro" dam. This consisted of a series of forked stakes driven into the sand of the river bed at intervals of 6 or 8 feet across the stream, inclined slightly upstream. These stakes were as large as could be driven firmly by hand, and poles were placed in the crotches of the stakes, and lashed firmly to them, thus forming a one-pole fence across the river, 3 or 4 feet high. Brush was leaned against this fence from the upstream side, lashed to the fence, and rock piled upon the brush ends where they lay upon the river bed; earth was dumped on the rock to make it tight. Larger rock was sometimes placed as a pavement on the downstream side of this rude dam, to resist the erosion of the falling water.

Improvements on this form of dam by the use of heavier piling driven by machinery and the use of larger rock constituted

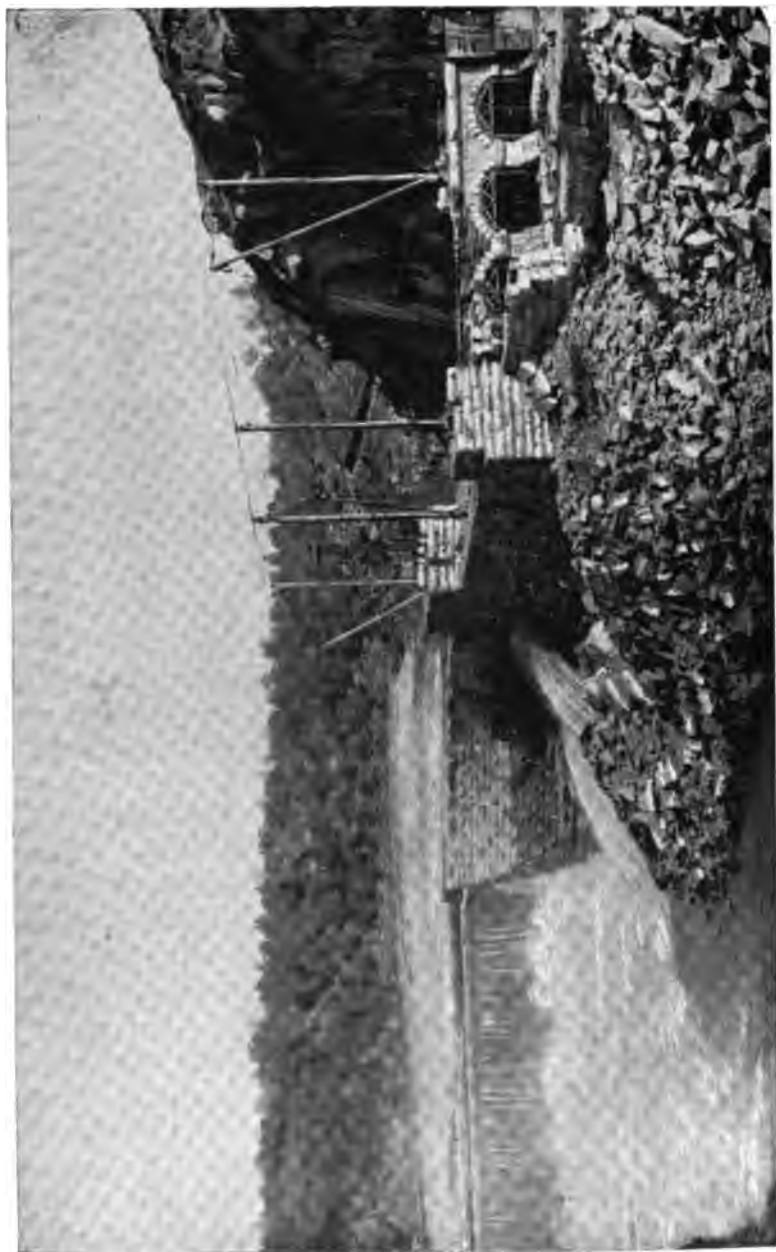

FIG. 178.—Folsom Canal, View of Weir and Regulator.

the essential features of most of these temporary structures which were cheap, but very precarious. They could be built only when the river was low, and often caused partial or total loss of crops by going out when most needed. When subjected to alternate wet and dry conditions, wood decays rapidly.

When a timber dam is built in a stream which is subject to great fluctuations of head and perhaps dry at times, the wood tends to decay, and it is good practice to combine timber and concrete construction in such cases. The foundation, apron and other parts which will be perpetually wet may be built of wood, and be considered permanent, while those parts which may be dry at times, the superstructure and abutments, are built of concrete.

A form of low timber diversion dam sometimes built consists of a plank platform held in place by a series of piling driven into the river bed. On this foundation timber frames are erected at close intervals in the form of the letter A. These are firmly bolted to the foundation, and the upstream legs of the frames closed with heavy planking. The water is allowed to flow over the top of this diaphragm and fall upon the plank platform below, which is placed a little below the natural river bed, and is perpetually submerged. Such dams have been used successfully in many cases.

b. Rectangular Pile Weirs.—These have been employed in wide sandy rivers like the Platte, in Colorado. They consist of a double row of piling driven into the river-bed, the two rows being about 6 feet apart, and the piles about 3 feet apart between centers. Between these is driven sheet piling to prevent the seepage or travel of water through the barrier, and the upper portion of the structure is planked so as to form a rectangular wall the interior of which is filled in with gravel, sand, etc. Such walls are usually low, rarely exceeding 8 feet in height, and after the upper side is backed with the silt deposited from the stream they form substantial barriers which may last a few years. Such structures cannot be employed where the flood height is great, as they would soon be undermined unless substantial aprons were constructed.

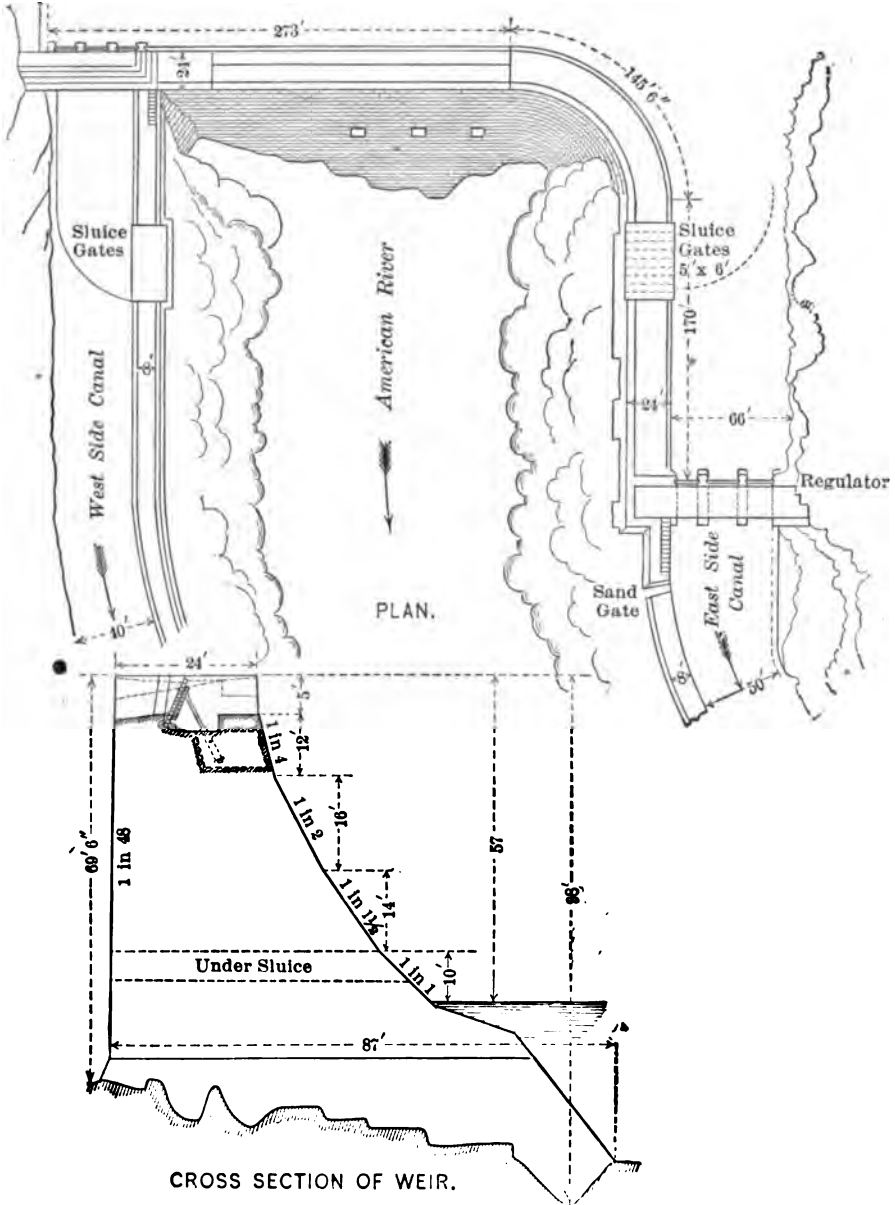

FIG. 179.—Folsom Canal Plan and Cross-section of Weir.

c. Open and Closed Weirs.—A closed weir is one in which the barrier which it forms is solid across nearly the entire width of the channel, the flood waters passing over its crest. Such weirs have usually a short open portion in front of the regulator known as the “scouring-sluice,” the object of which is to maintain a swift current past the regulator entrance, and thus prevent the deposit of silt at that point. An open weir is one in which scouring-sluices or openings are provided throughout a large portion of its length and for the full height of the weir.

The advantage of the closed weir is that it is self-acting, and if well designed and constructed requires little expense for repairs or maintenance, but it interferes with the normal regimen of the river, causing deposit of silt and perhaps changing the channel of the stream. Open or scouring-sluice weirs interfere little with the normal action of the stream, and the scour produced by opening the gates prevents the deposit of silt.

The closed weir consists of an apron properly founded and carried across the entire width of the river flush with the level of its bed, and protected from erosive action by curtain-walls up- and downstream. On a portion of this is constructed the superstructure, which may consist of a solid wall or in part of upright piers, the interstices between which are closed by some temporary arrangement. During floods the water backed against the weir acts as a water cushion to protect the apron, and as the flood rises the height of the fall over the weir crest diminishes, so that with a flood of 16 feet over an ordinary weir its effect as an obstruction wholly disappears. A rapidly rising flood is more dangerous than a slowly rising flood, not only because of its greater velocity, but because it causes a greater head or fall over the weir as the water has not had time to back up below and form a water-cushion. For the same reasons a falling or diminishing flood is less dangerous than a rising flood.

An open weir consists of a series of piers of wood, iron, or masonry, set at regular intervals across the stream bed and resting on a masonry or wooden floor. This floor is carried across the channel flush with the river bed or lower, and is protected from erosive action by curtain-walls up- and downstream. The

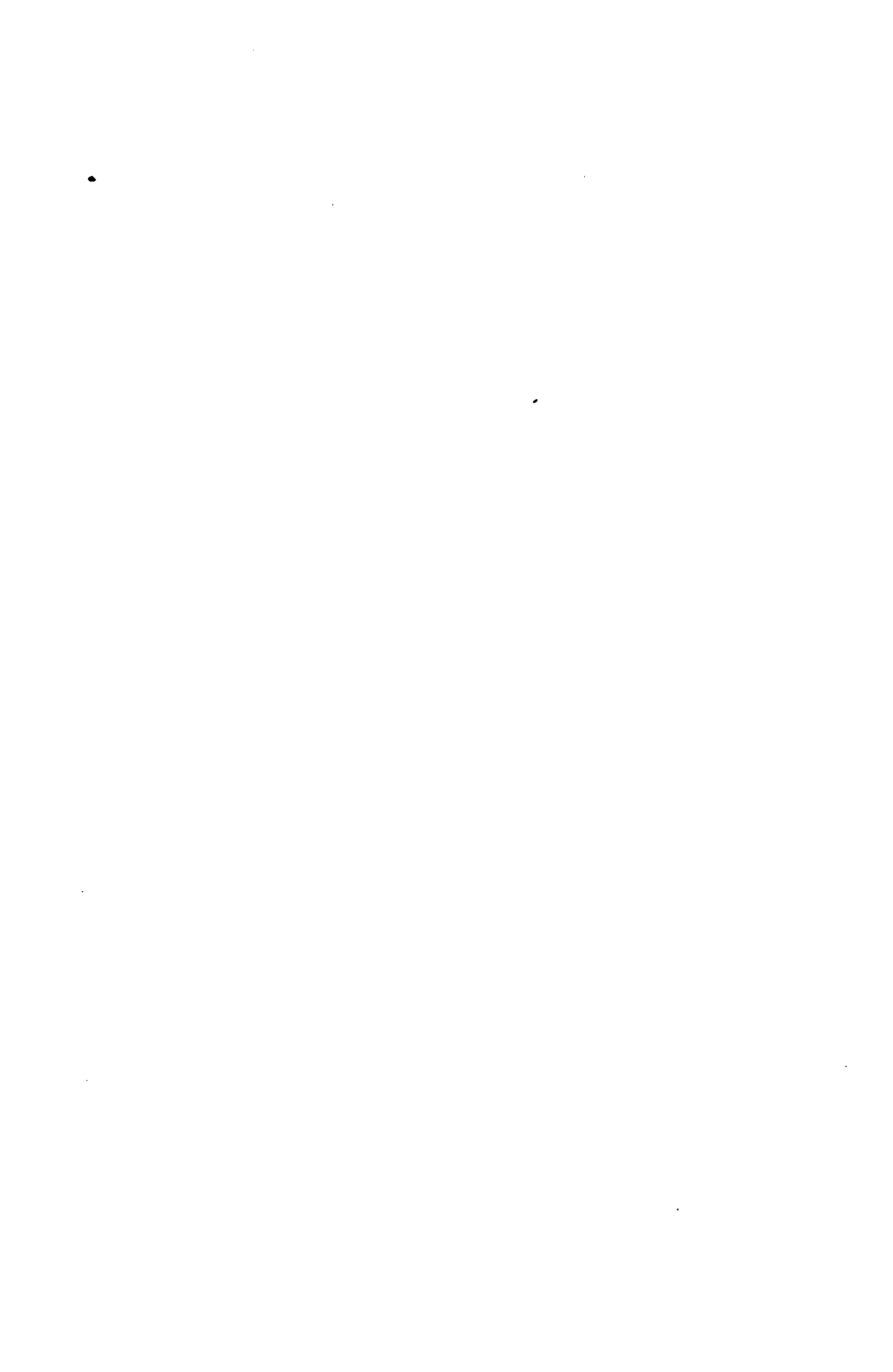

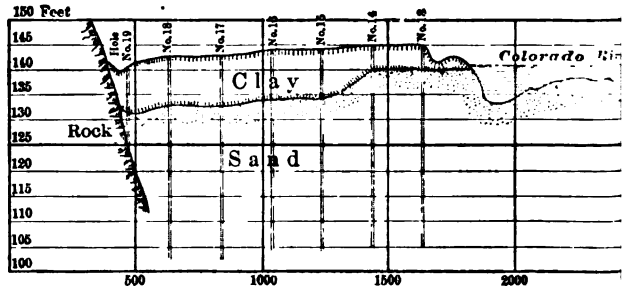
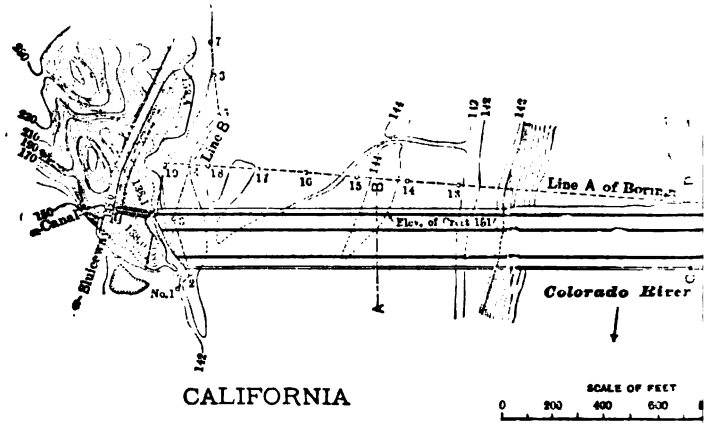

PROFILE

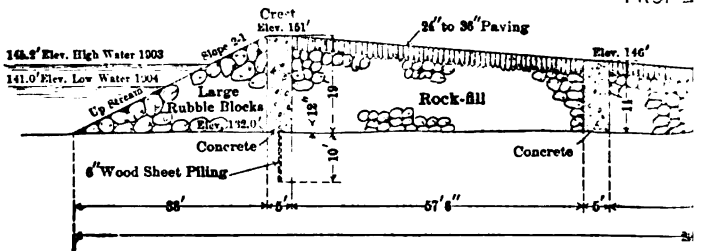

MAXIMUM

FIG. 180.—Plan and Section

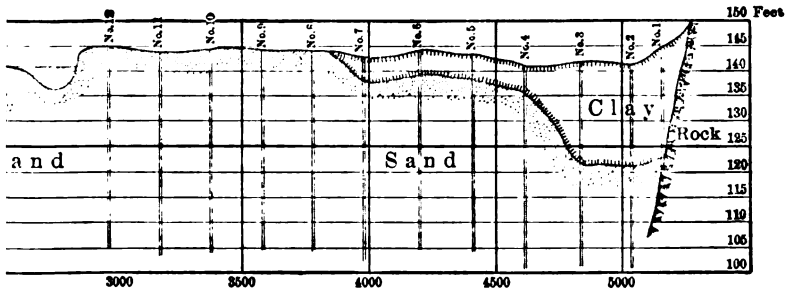
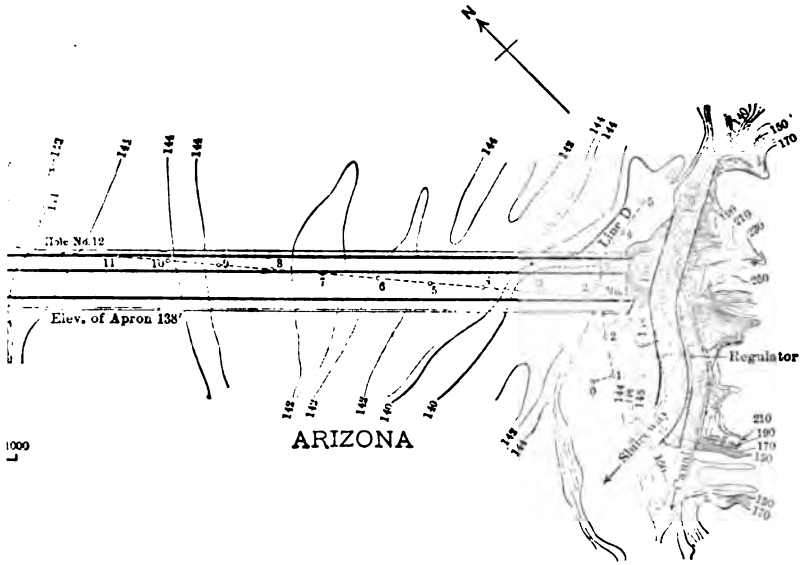

BORINGS ON LINE A

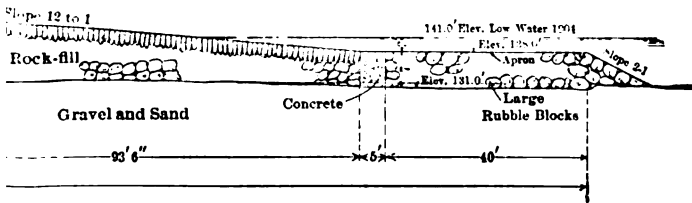

SECTION ON C-D
of Laguna Dam, Colorado River.

To face page 386.

piers are grooved for the reception of flashboards or gates so that by raising or lowering these the height of the river can be controlled. The distance between the piers varies between 3 and 10 feet, according to the style of gate used. If the river is subject to sudden floods these gates may be so constructed as to drop automatically when the water rises to a sufficient height to top them. It is sometimes necessary to construct open weirs in such manner that they shall offer the least obstruction to the waterway of the stream. This is necessary in weirs like the Barge du Nil, below Cairo, Egypt, or in some of the weirs on the Seine, in France, in order that in time of flood the height of water may not be appreciably increased above the fixed diversion height. Should the height be increased in such cases the water would back up, flooding and destroying valuable property in the cities above. Under such circumstances open weirs are sometimes so constructed that they can be entirely removed, piers and all, leaving absolutely no obstruction to the channel of the stream, and in fact increasing

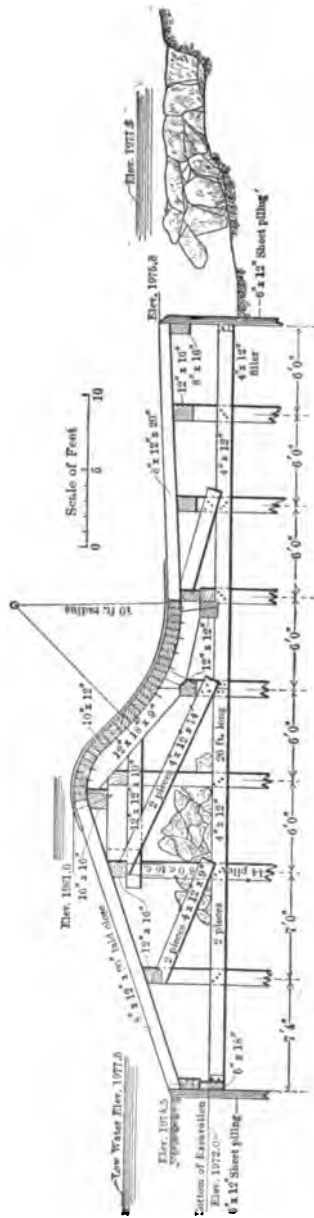

FIG. 181.—Cross-section of Lower Yellowstone Weir, Mont

its discharging capacity, owing to the smoothness which they give to its bed and banks.

d. Flashboard Weirs.—A form of cheap open weir which has been commonly constructed in the West is the open wooden frame and flashboard weir. This type of structure is used only on such rivers as have unstable beds and banks, where any obstruction to the ordinary regimen of the stream would cause a change in its channel. It consists wholly or in part of a foundation of piling driven into the river bed, upon which is built an open framework closed by horizontal planks let into slots in the piers. These weirs are constructed of wood, and are temporary in character, their chief recommendation being the cheapness with which they can be built in rivers the beds of which are composed of a considerable depth of silt or light soil.

A more common type of frame or flashboard weir is that employed on the Kern River in California. (Fig. 182.) An example of this is the weir at the head of the Calloway canal (Fig. 183), which consists of 100 bays, each separated by a simple open triangular framework of wood founded on piles, the width of each opening or bay being 4 feet. Two and one-half feet below the bed of the stream is a floor, with walls about 2 feet in height, forming compartments filled with sand on which the waters fall. This apron is carried up- and downstream for a distance of about 10 feet in each direction. The weir proper is formed of frames or trusses of 6 by 6 inch timber, placed transversely 4 feet apart. These frames consist of two pieces, the upstream piece being 15 feet 2 inches long and set at an angle of 38 degrees, while the other supports it at right angles and is 9 feet 4 inches long. The lower ends of these rafters thrust against two pieces of 6 by 2 inch timber running the whole length of the weir and nailed to the flooring. These frames are supported directly on anchor piles, one at each end joiced into the framing. These trusses are kept in vertical position by means of a footboard running transversely the entire width of the stream. On the upstream face of the trusses planks or flashboards which slide between grooves formed by nailing face-boards on the trusses are laid on to the

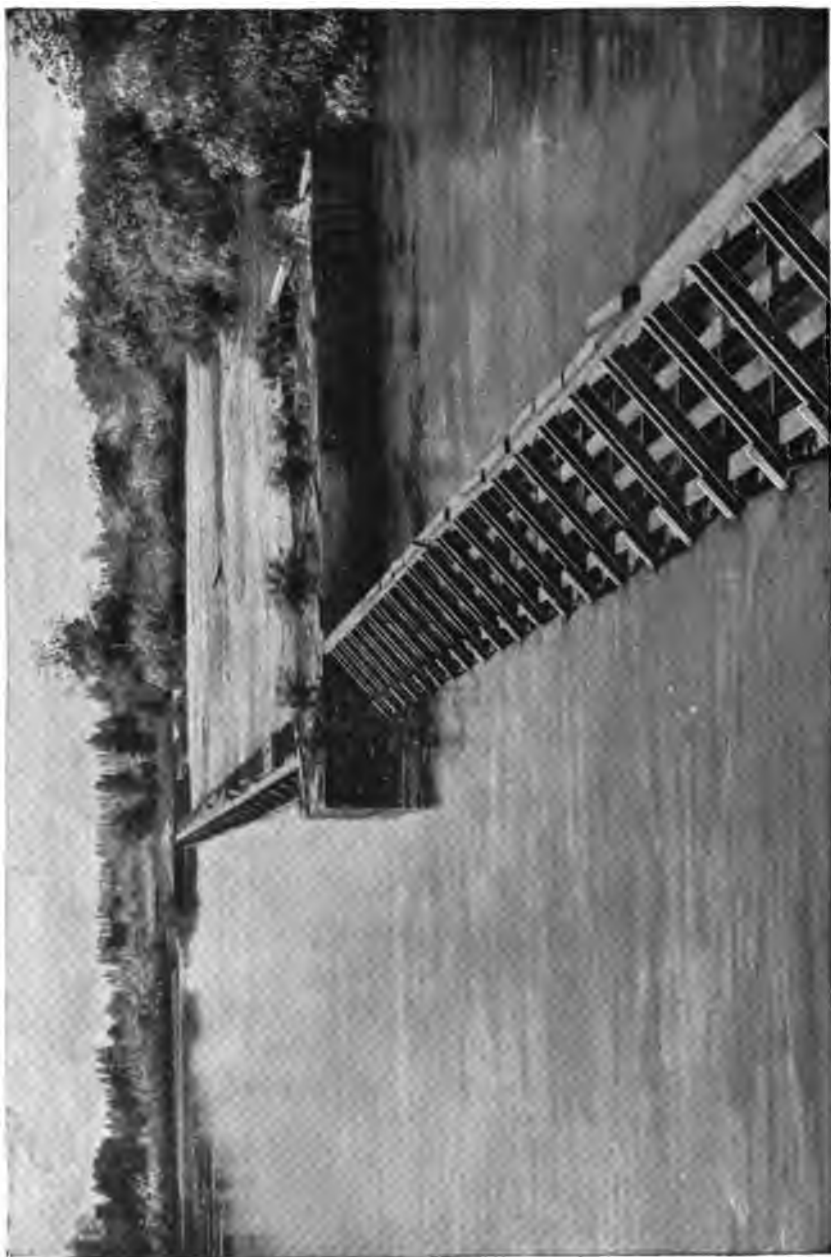

FIG. 182.—Kern River Diversion Weir. Head of Calloway Canal.

required height. This weir is 10 feet in height above the wooden floor, which is flush with the river bed.

e. Indian Type Weirs.—A substantial form of weir is that generally constructed on Indian rivers, where the banks and bed are of sand, gravel, or other unstable material. These weirs generally rest on shallow foundations of masonry, in such manner that they practically float on the sandy beds of the streams.

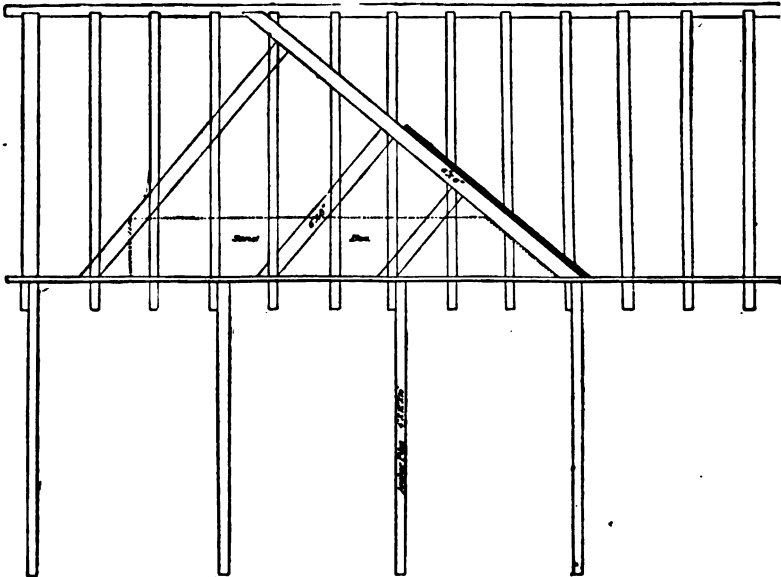
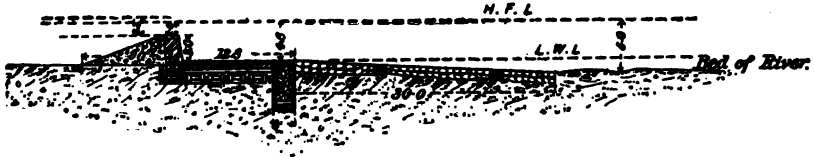

FIG. 183.--Cross-section of Open Weir, Calloway Canal.

The foundation of such a weir is generally of one or more rows of wells sunk to a depth of from 6 to 10 feet in the bed of the river, the wells and the spaces between the wells being filled in with concrete, thus forming a masonry wall across the channel. A well or block is a cylindrical or rectangular hollow brick structure, which is built upon a hard cutting edge like a caisson, and from the interior of which the sand is excavated as it sinks. After it has reached a suitable depth it is filled with concrete, depending partly for its stability on the friction against its sides. This form of construction is illustrated in Fig. 184.

NARORA WEIR - LOWER GANGES CANAL.
Length 1260 metres



OKHLA WEIR - AGRA CANAL.
Length 743 metres

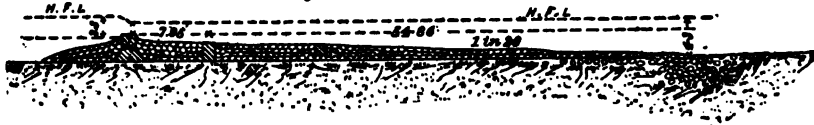

DEHREE WEIR - SOANE CANAL.
Length 3825 metres



BEZWARA WEIR - KISTNA CANAL.
Length 1150 metres.

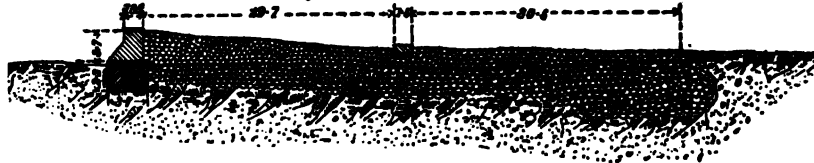

GODIVERY WEIR.
Length 627½ metres.



FIG. 184.—Cross-sections of Indian Weirs.

f. Automatic Shutters and Gates.—The use of flashboards or any similar permanent obstruction in a wasteway in order to increase the storage capacity of the reservoir is to be discouraged. Such obstructions must be removed at the time of great floods or else these will top the dam, which depends upon the attention of watchmen, who may be absent or negligent. Automatic shutters, however, have been used with considerable success in a few instances.

One of the most desirable forms of these is that shown in Fig. 185. It consists of a row of upright iron shutters, each 18 feet long and 22 inches high. These are supported by tension-rods hinged to the crest of the weir on the upstream side, and to the upper side of the shutter at about two-thirds of the distance from its crest, or, in other words, below its center

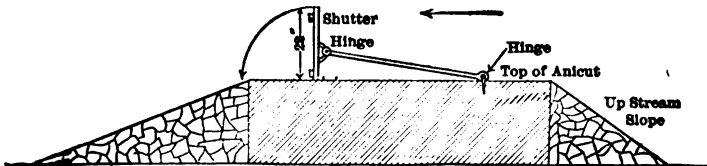

FIG. 185.—Cross-section of Shutter on Soane Weir, India.

of pressure. As soon as the water-level approaches the top of the shutter it causes its lower end to slide inward and the whole falls flat against the top of the weir, offering no obstruction to the passage of the water.

g. Automatic Drop-shutters.—The shutters, added in 1901 to the crest of the Betwa weir at Paricha, India, to increase the reservoir capacity may be taken as illustrative of the latest Indian practice in the design of automatic drop-shutters.

The shutters are each 6 feet high and 12 feet long, and as the length of the weir crest is 3600 feet there are 300 such shutters. They are made entirely of steel, consisting of $\frac{1}{4}$ -inch plates joined along their middle and stiffened both longitudinally and laterally by angle-iron $3\frac{1}{2}$ by $2\frac{1}{2}$ by $\frac{3}{8}$ inch (Fig. 186). To the flanges of the vertical stiffeners are pivoted $1\frac{3}{4}$ -inch tension-bars. The other end is similarly attached to anchor-

bolts built 2 feet into the masonry crest of the weir. There are four such tension-bars to each 12-foot gate. The point of attachment of the tension-bar and shutter is so designed that the gates fall automatically with a given depth of water passing

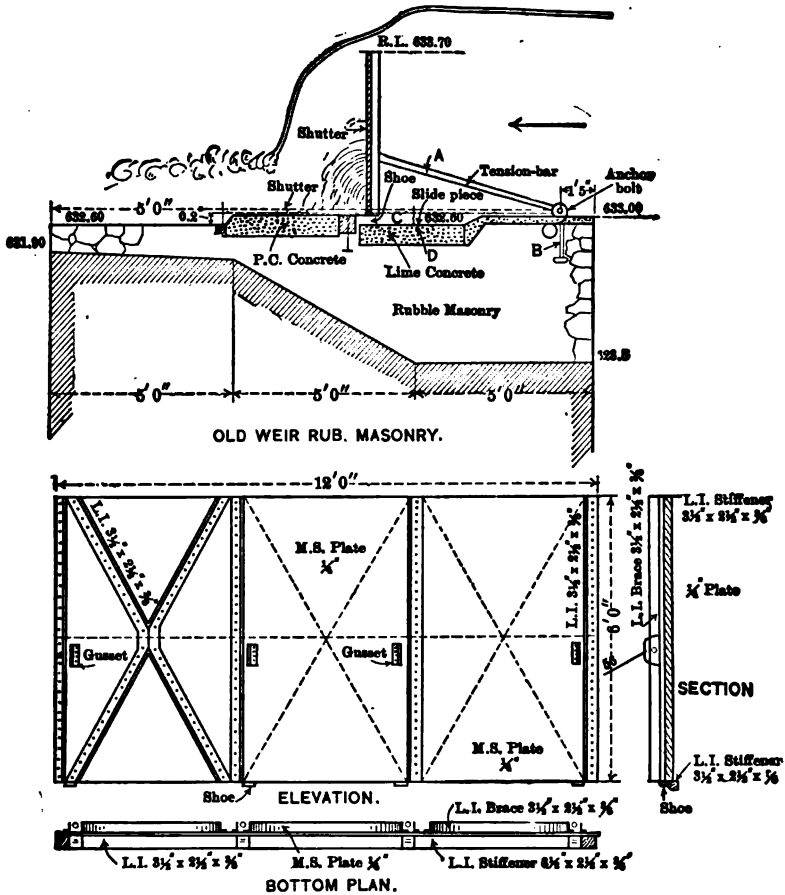

FIG. 186.—Automatic Drop-shutter, Betwa Weir, India.

over them, thus securing safety in case of excessive floods. The bottom of each gate is supplied with four steel shoes, which rest upon sliding-plates built into the weir crest, thus reducing the frictional resistance when the gates fall. Wooden baulks 4 by 4 inches are fixed to the ends of the shutters, which have a

space of 1 inch separating them, which is caulked when the gates are raised.

If the 300 shutters were to fall together the shock would unduly strain the weir and the flood volume submerge the river-banks below. Hence the attachment of the tension-bars has been so arranged that each third gate falls under different depths of water. The first third fall with a depth over top of 2 feet, the next with 3 feet, and the last with 4 feet. Thus after the first third fall the released water reduces the flood depth, and the latter must increase considerably to top the second third, and so on for the last third.

These shutters were subjected to an unusual test, immediately after completion, in the form of an extraordinary flood which passed over the weir crest to the height of 16.4 feet, when it had been designed to withstand a previous known flood height of only 6.5 feet. Fortunately the shutters worked successfully and neither weir nor shutters sustained material injury.

h. French Type.—The weirs on the River Seine in France differ materially from the Indian weirs. They consist of a series of iron frames of trapezoidal cross-section, somewhat similar in shape to the frames of the open wooden flashboard weirs of California. On these frames rest a temporary footway, and on their upper side is placed a rolling curtain shutter or gate which can be dropped so as to obstruct the passage of water across the entire channelway of the stream, or can be raised to such a height as to permit the water to flow under them. In times of flood the curtain can be completely raised and removed on a temporary track to the river banks, the floor and track can then be taken up, leaving nothing but the slight iron frames, which scarcely impede the discharge of the river and permit abundant passageway of the floods over, around, and through them (Fig. 188).

i. Roller Dams.—A movable dam invented and patented in Germany, consisting of steel rollers, capable of being rolled up an incline when required to pass floods, has been used in that country and also in a few instances in the United States.

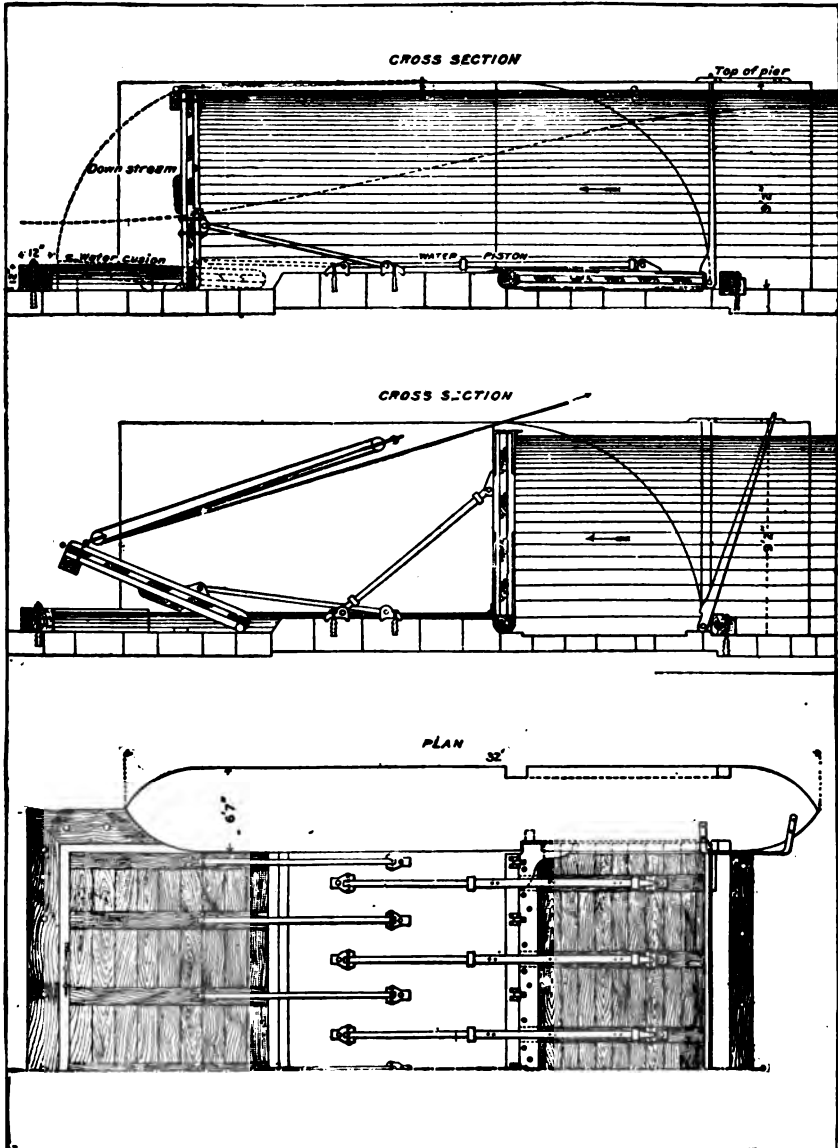

FIG. 187.—Falling Sluice-gate. Soane Canal, India.

The largest one built in this country is on Grand River, about eight miles above Palisade, Colorado.

In the diversion of Grand River, the problem presented was to raise the level of the river at low stages sufficiently to divert 1400 cubic feet of water per second into the head of the canal, and yet at high water to pass a flow of 50,000 cubic feet of water per second without raising the water to a level where it would endanger the roadbed of the railroad adjacent. This required a movable crest upon a concrete weir.

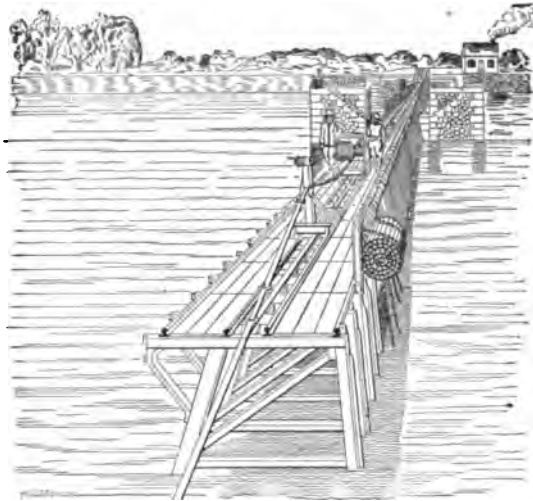

FIG. 188.—View of Open Weir on River Seine, France.

The dam developed is a concrete base of ogee section with projecting apron, surmounted by a series of seven movable roller dams, six of which are 70 feet long and 10.25 feet high, over the dam proper, while the seventh has a span of 60 feet and a height of 15.3 feet, and is used to control the sluiceway. The total length of the structure is 536.5 feet. When the rollers are closed at low water it raises the water 20 feet above the bed of the river. See Fig. 190.

The canal regulator gates are parallel to the river, and nearly on a line with the natural bank, and the sluiceway roller closes upon a sill 5.1 feet below the sills of the other rollers, and 8.3

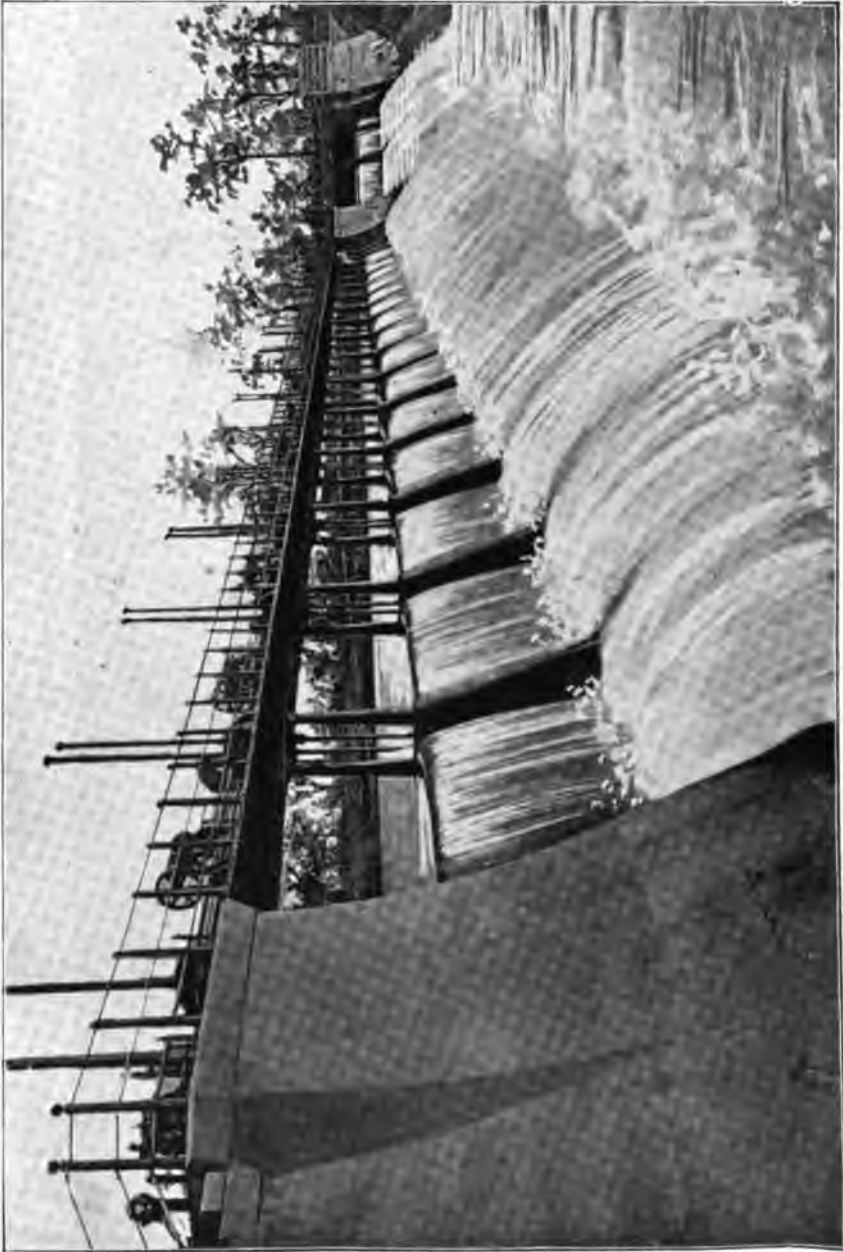

FIG. 189.—View of Goulburn Weir, Australia.



FIG. 190.—View of Rolling Dam, Grand River, Colorado.

feet below the sills of the canal gates, so that gravel will be deposited instead of passing into the canal, and can be sluiced out by raising the 60-foot roller, and thus a deep settling basin

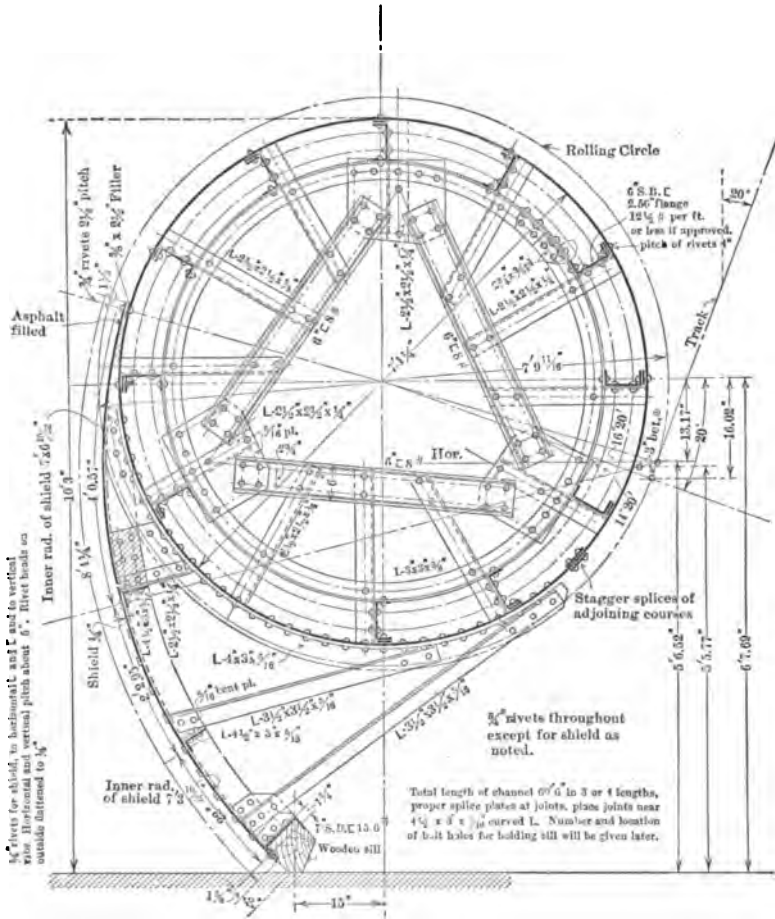

FIG. 191.—Section through Body of 70-foot Roller Dam, Grand River, Colorado.

can be maintained in front of the gates, to prevent the river gravel from entering the canal.

The hoisting apparatus for the sluicing roller is located on the right abutment of the dam, which serves also for the left abutment of the headgate structure. The other six rollers are

operated by three hoists located on alternate piers, each hoist serving two rollers. These piers are 10 feet wide, and the other three are 8.25 feet wide. A steel truss bridge spans each opening. Each hoist is equipped with an electric motor receiving current from a gas engine in the gate house on the right abutment

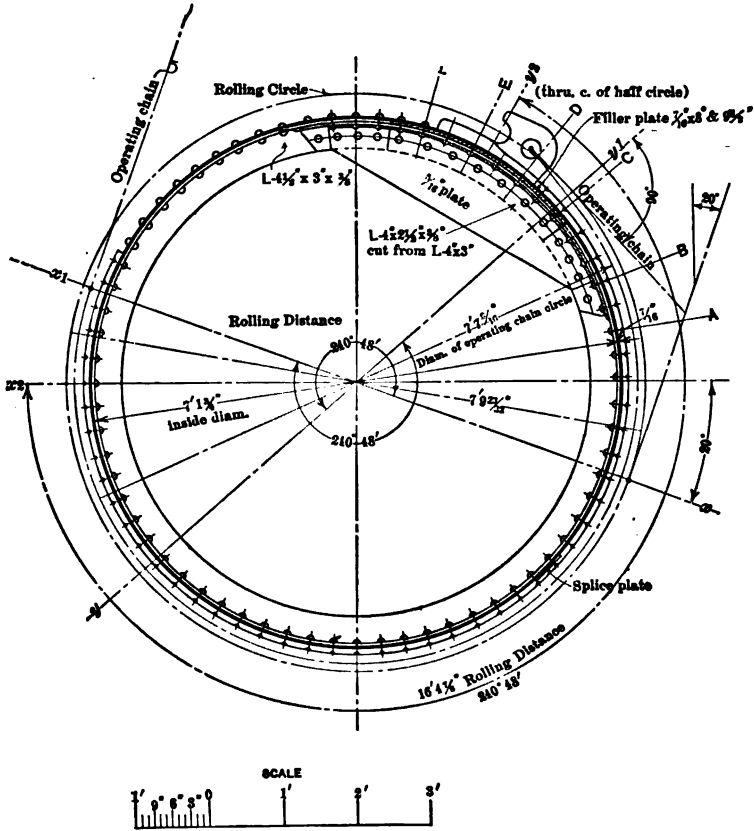

FIG. 192.--Section through Driven End of 70-foot Roller.

pier. The rollers are lifted by rolling them up the inclined tops of the piers.

The advantages of this type of movable dam, are its long span, requiring but few piers to obstruct drift, the ease and speed with which it can be opened, and the tightness of closure, permitting little leakage.

j. Crib Dams.—A type of dam much employed in early days, and still frequently built, consists of a series of cribs built of logs firmly bolted or pinned together, and filled with large and small rock to give weight and stability. The cribs are rectangular, from 12 to 16 feet square, and longer timbers extend from one crib to the next to bind them firmly together. A floor of heavy timbers is provided near the bottom of each crib for holding the rock. The bottom of each crib should be drift-bolted to the foundation if of rock, and sunk as low as possible into any softer foundation, and sheet piling may be added to stop percolation under the dam. It is best to give the dam a slope of 45 degrees or flatter on the upstream face, and to cover this with

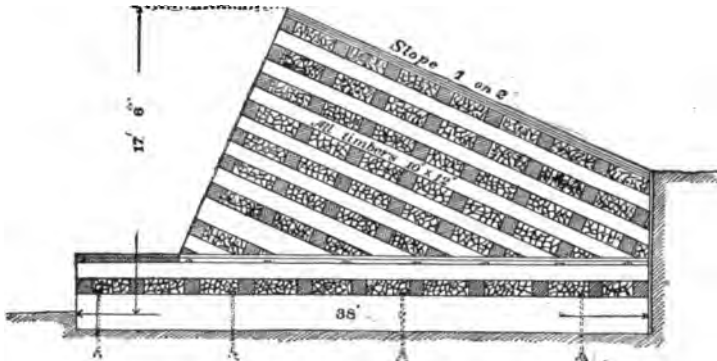

FIG. 193.—Cross-section of Bear River Weir.

planking for water tightness. The lower side may be likewise sloped and covered with planks, but it is best to make this slope steep at top, and gradually flatten it toward the bottom to give the falling water gradually a horizontal direction as it leaves the dam. The bottom of the river for some distance below the dam should be protected from erosion by submerged cribs covered with heavy planks or sawn timbers, and filled with the largest available rock.

Where a crib dam is of considerable height, the downstream slope is sometimes made in a series of steps to break the fall of the water and dissipate the greater part of its energy before reaching the toe of the dam.

k. Submerged Dams.—In desert regions, it frequently happens that small streams emerge from the mountains and are lost in the sands and gravels of the desert before reaching any larger stream, or other outlet. In times of flood the water flows

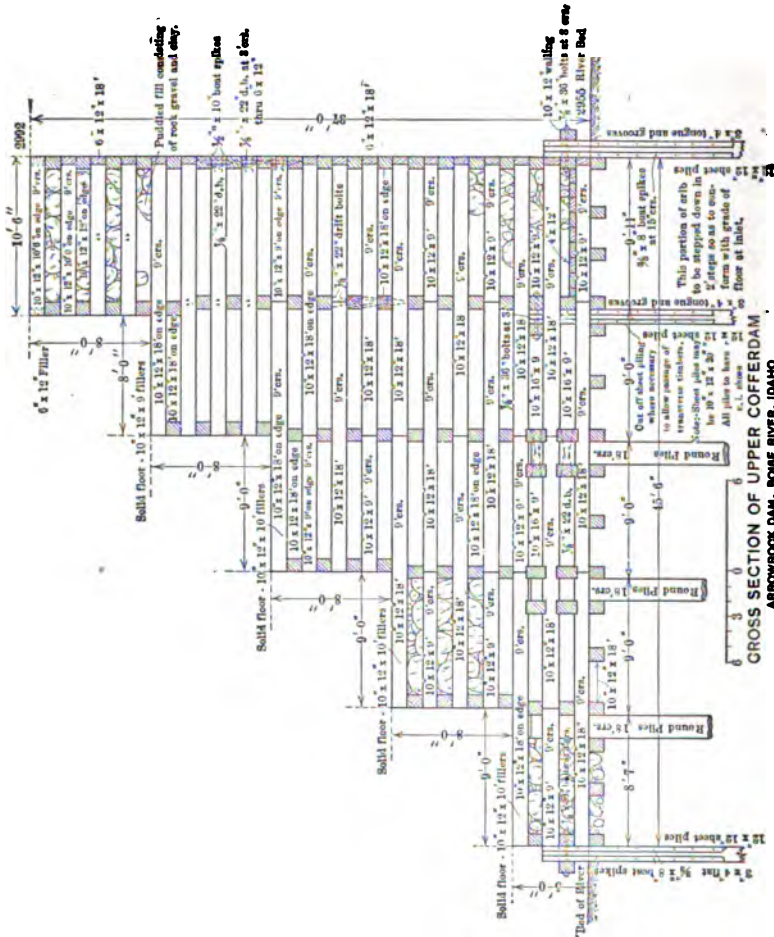

FIG. 194.—Cross-section of Upper Coffer-dam, Arrowrock Dam, Boise River, Idaho.

a much greater distance over the desert than normally, and in so doing forms a water course which is usually dry on the surface or nearly so. Numerous attempts have been made to bring the underflow to the surface by sinking concrete or wooden dams, called submerged dams, in the ground across

the water course. These have at times collected some water, but the quantity has usually been disappointing.

One such structure is the dam on Pacoima Creek in California, the property of the San Fernando Land and Water Company. At the site of the dam the sandstone canyon walls are about 800 feet apart and the bed rock about 45 feet below the surface of the gravel bed of the stream. Through this a



FIG. 195.—View of San Fernando Submerged Dam.

trench was excavated across the canyon in which a rubble masonry wall was built, its base being about 3 feet thick and its top 2 feet reaching 2 or 3 feet above the stream bed. On the line of this wall are two large gathering wells, and on its upper face pipes are laid in open sections, so that the seepage water caught by the dam might enter these and be led through them into the wells, from which it is drawn off for purposes of irrigation. Above the dam the stream bed consists of several hundred acres of gravel 12 to 20 feet in depth, which forms a natural storage reservoir of 1200 to 1500 acre-feet capacity.

A somewhat similar submerged dam is in operation at Kingman, Ariz., for providing a small supply to the town and railway.

A masonry wall 173 feet long on top, 6 feet wide at base, and 2 feet wide on top is built on bed-rock across and through the gravel bed of railroad canyon. A 6-inch cast-iron outlet pipe through the dam, 12 feet below its crest, which is below the level of the canyon bed, leads into an 8-inch standpipe perforated with $\frac{3}{8}$ -inch holes placed $\frac{1}{2}$ inch apart. In this is collected the water which gathers behind the dam to the full height of its crest.

3. Storage Dams.—Storage dams may be classified into four general groups according to the materials of which they are composed as follows:

1. Earth dams or embankments.
2. Rock-filled dams.
3. Steel dams.
4. Masonry dams.

Numerous modifications and combinations of the above types are often employed, as for example, a combination of the earth and rock-fill types, of which this chapter treats.

The type of dam to be constructed at any given site is determined chiefly upon consideration of three leading elements which are usually capable of interpretation in terms of cost.

1. Character of available materials for construction.
2. Character of foundation and abutment.
3. Length and height of dam.

It often happens that the dam-site is in a rocky canyon, where there is not available within reasonable distance a sufficient quantity of material suitable for an earthen dam, and the difficulty of making a tight bond between the rock and an earth embankment, furnishes additional reason for rejecting this type.

Where the dam-site is a narrow gorge with good rock foundation and abutments so that a masonry dam of light section depending on arch action can be built, this type is usually the cheapest, and commends itself to the general public for its safety and stability if well built.

If the gorge is more than 600 feet wide at the top of the proposed dam, so that little advantage can be secured from arch

action, the rock-fill type may be worthy of consideration in comparison with a masonry dam.

Where the dam is to be of considerable length, and conditions are at all favorable for an earthen dam, this type is generally cheapest, can be made perfectly safe, and its choice is therefore advisable unless it is to be very high, in which case masonry should also be considered if a foundation of good rock is available.

a. Earthen Dams or Embankments.—The essential features of a serviceable earthen dam are five:

1. That it is protected by an ample spillway, from the flow of water over any portion.
2. That the water slope or the center, or both, be practically impervious to water.
3. That the foundation and abutments be practically impervious, and connected with the dam by a water-tight bond.
4. That the water slope be protected from wave action by paving or riprap.
5. That both slopes be sufficiently flat to insure the class of material used against sloughing.

There are three general types of earthen dams, classified with reference to the portion made impervious:

1. Dams having a central core of puddled earth, or a central wall of masonry.
2. Dams having the water face and center built of selected material made nearly impervious, and coarser material used on lower face.
3. Dams built in layers of homogeneous material throughout, which must of course be nearly impervious.

It must be remembered that all earthen masses, and most rock and concrete is capable of absorbing and transmitting some water if sufficient pressure be applied, and so when we speak of impervious materials in earthen dams, we speak relatively.

b. Foundation.—No feature of the site for an earthen dam is more important than the foundation, and this should be examined with great care. If it consists of alluvial material deposited by water, it is likely to contain pervious strata of sand or gravel,

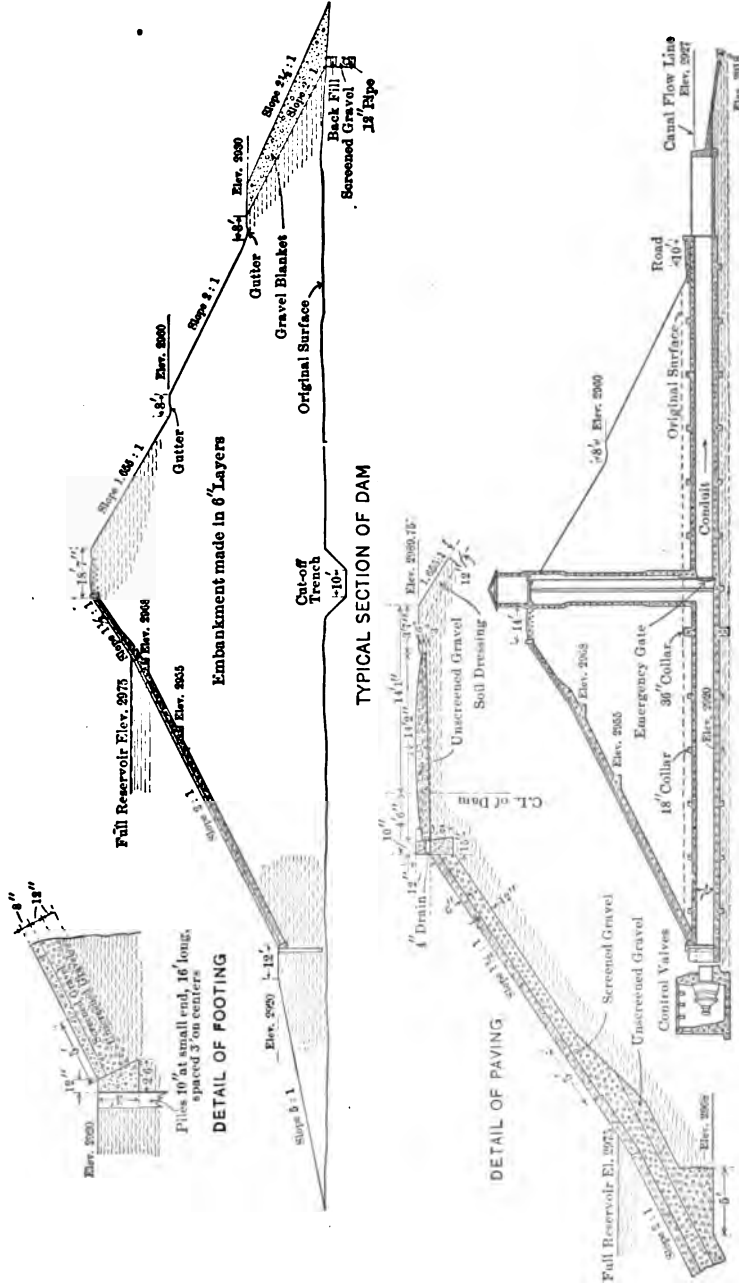

FIG. 196.—Sections of Owl Creek Storage Dam, Belle Fourche Project, S. D.

and these if left undisturbed will produce leakage under the dam, which under the head of water in the reservoir might attain destructive velocities and cause disaster. Free percolation must be entirely prevented, and all percolation must be made so slow and devious that it will be inert, and without danger of destructive erosion. In general it is necessary to provide a wide cut-off channel or core wall, carried down to rock, or to a thick bed of relatively impervious material, through which such percolation as occurs will be very slow. The best foundation for an earthen dam is a thick bed of impervious clay mixed with a large proportion of sand and gravel thus combining water-tightness with stability. A foundation of fine sand is not permissible unless it contains some clay or impalpable silt. In the case of any foundation which will permit some percolation, there is an advantage in making the path which the water must follow in order to reach a free escape, as long as possible, which may be secured by spreading the base of the dam if this is made of impervious material, thus confining the percolating waters for a greater distance before they can escape. It was upon this theory that the Gatun Dam on the Canal Zone was given very flat slopes, and a very wide base. If an earthen dam is to be connected with rock either in its foundations or abutments, it should be by means of one or more walls of concrete, cemented tightly to the rock, and extending several feet into the earthen embankment. The earth around these concrete cut-off walls should be carefully selected, puddled and rammed, so as to give the tightest possible connection.

In preparing the foundation of an earthen dam for the embankment, the surface soil should be removed from the foundation to a depth sufficient to remove all coarse vegetation, and the entire foundation scored by deep furrows running longitudinally of the dam, so as to form a good bond with the embankment material.

If pervious strata of sand or gravel occur below the surface, one or more trenches should be carried down through such strata for the entire length of the foundation, and refilled with selected material carefully rammed or puddled in place.

c. Springs in Foundations.—It sometimes happens that one or more springs occur at the site where it is desired to build an earthen dam. This is very undesirable, and if possible a site should be selected which is free from this menace. Where

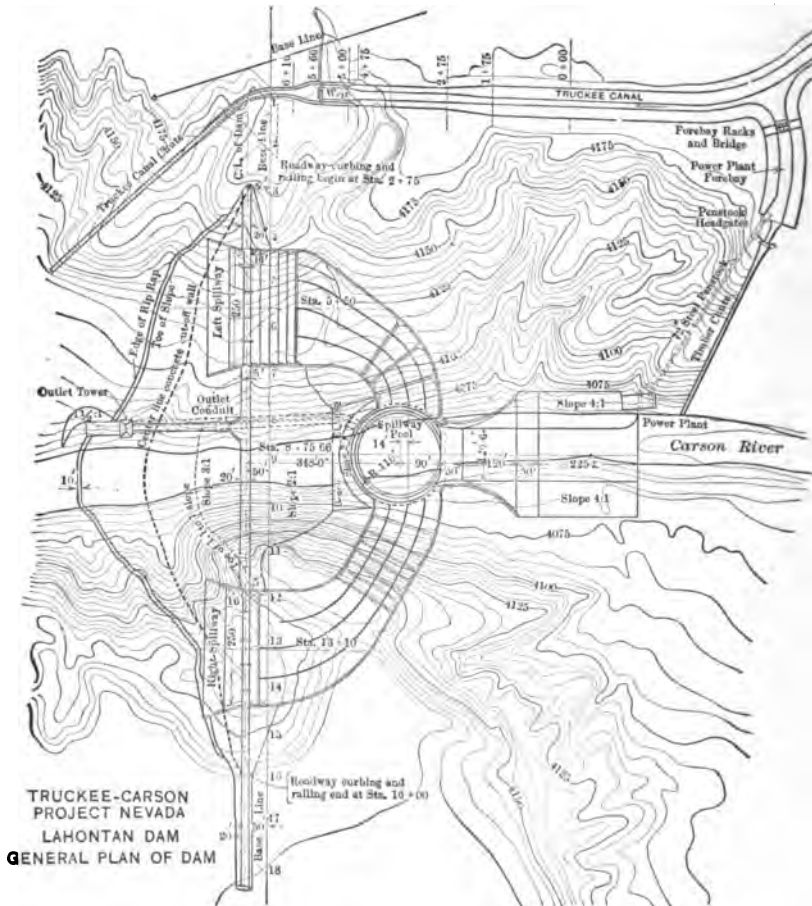

FIG. 197.—Plan of Lahontan Dam, Carson River, Nevada.

this is not possible, the utmost precaution must be taken to prevent the spring from endangering the structure. If possible the spring should be followed to its point of emergence from the rock. If the rock is hard and firm, it may be possible to seal

the spring with a mass of concrete. If this is done, careful examination should be made to determine whether the spring has broken out at some other point. If the spring does not flow from rock, it may be followed to relatively firm material, and there confined into a pipe and led away and discharged at a distance from the dam, due precaution being taken against the percolation of water through the bank along the pipe. Or still better the pipe may be carried upward and sloped upstream if necessary, until its top is above the flow line of the reservoir, and the water allowed to flow out at the top if it will, and fall into the reservoir.

If the springs are small, it may be possible to smother them by puddled material, but this should be done with caution, and careful examination made to detect their escape at other points. This method should never be attempted, however, unless excellent and abundant puddle material is used for the purpose, and the spot is buried under a great mass of which the weight and character is a guarantee against any escape of the water or any portion of it. This process should never be applied to springs below the center line of the dam, where they might saturate the lower portion of the dam and cause a tendency to slough. The handling of springs in foundations is a very important and delicate problem requiring experience and mature judgment, as an error in the solution of this problem may lead to serious consequences.

d. Safe Slopes for Earthen Dams.—One of the strongest tendencies to failure of an earthen dam is the saturation of its mass with water, with a consequent tendency to neutralize its cohesion and to cause parts of it to become of a semi-liquid nature, so that it will slide or slough. This is one great reason for the importance of making the water face as tight as possible against the entrance of water, and of providing drainage under the downstream half of the embankment. For this reason, the water slope of the dam is made relatively flat, generally 1 on 3 or flatter, and the downstream slope always 1 on 2 or flatter, although the natural angle of repose of the earth used may be nearly as steep as 1 to 1. The gentle slope of the water

face of the dam contributes to its stability not only by providing a large amount of weight, but by giving the direction of water pressure a downward tendency, the direction of pressure of a liquid being always normal to the surface upon which it is exerted. The water pressure on a 3 to 1 slope of a dam being more nearly vertical than horizontal increases its effective weight, and increases its stability against sliding, and also against overturning if such a method of failure were possible.

It appears therefore that the mass and shape of an earthen dam as thus determined is such that no attention need be paid to its stability against sliding on its base or on any horizontal joint, on account of the pressure of the water in the reservoir.

The other considerations, however, make the slopes of the two faces of the dam very important.

It is impossible to arrive by theoretical reasoning at reliable general rules for the slopes upon which any given materials will be stable when saturated with water. In general, a clay bank when supersaturated has very little stability, and the same is true in a less degree of a clay loam and of a sandy clay loam where the clay content predominates. Where clay must be used it is very important to prevent its saturation, by excluding the water so far as possible, and providing an exit for such water as may enter it. For this reason it is desirable to employ gravel for the downstream half of an earthen dam, as this will permit the slow escape of contained water, without danger of sloughing or erosion. For the same reason it is highly desirable that the impervious portion of the dam also be composed largely of gravel, using fine sand and clay only so far as necessary to completely fill the void spaces in the gravel.

The great Gatun Dam on the Canal Zone, Panama, is built on the gentlest slopes of any dam of which we have record. The outer slope is about 16 to 1 for 40 feet in height, and there increases to 7 to 1, and finally to 4 to 1 near the top. The water slope averages about 4 to 1 for most of the height. The base width is thus 2640 feet while the height is only 105 feet, and the contents over 21,000,000 cubic yards.

The reasons for adopting these very conservative slopes are several:

1. The sluiced clay of which the base of the dam is composed was considered practically impervious, or at least much less pervious than the valley material of the foundation. The broad blanket of sluiced clay confines waters percolating in the foundation and prevents their escape until they have traversed so long a distance that the accumulated friction has destroyed any possible hydraulic head and rendered the seepage inert. At the same time any seepage through the dam would produce a plane of saturation the surface of which in the clay material would be steep enough to intersect the foundation long before reaching the surface of the slope, and thus minimize any possible tendency to slough.

2. The adopted method of construction was the sluicing of clay into the body of the dam which is always very slow to drain and consolidate, and especially so in the wet climate of Gatun, and it was necessary to provide flat slopes for stability during construction.

3. It was desired to make an embankment so heavy that an alien enemy temporarily in possession could not quickly cause a break for the purpose of destroying the dam.

The practice so common as to be considered almost standard is to build earthen embankments with slopes of 3 to 1 on the water face and 2 to 1 on the outer or downstream face. These slopes may be flattened to fit cases where conditions of stability are not favorable, and may be somewhat steeper where rock or gravel predominates on the slopes, or other conditions favor unusual stability.

The slopes are frequently made steeper near the top than lower down, and this is a logical practice, as it broadens the base by the use of less material than required for uniform slopes. On the water face the steeper slope near the top tends to check the advance of waves.

The top width is generally made to vary from 10 feet for banks of moderate height to 20 feet or more for high dams. The top should be slightly crowned to prevent rain water from

standing on it in pools and causing saturation. The top of the dam should be high enough above normal high water so that no danger will ensue of waves from the reservoir overtopping the embankment. Where great wave action is to be expected a concrete wall is sometimes provided at the water edge of the top to break the waves. See Fig. 201.

e. Slope Protection.—The flattening of the slopes of an earthen dam, while increasing its security against sloughing and sliding, and adding to the security against the wave action upon the material of the slope, adds materially to the cost by increasing the yardage, and on the water slope by increasing the area that has to be protected from wave action by pavement or riprap. Where suitable rock is abundant for this purpose it may be inexpensive, but in some cases a concrete pavement is necessary, and it becomes desirable, for reasons of economy to reduce this area to the smallest dimensions. This reason led to the adoption of slopes for the Owl Creek Dam, South Dakota, of 2 to 1 on the water side for the most part, and constitutes it one of the boldest earth dams for its height now in existence. Its water face is protected by a heavy concrete pavement.

Where rock is plentiful the water slope should be protected by a pavement of dry laid rock not less than 1 foot thick where wave action is moderate to 2 feet where heavy wave action is to be expected. Precaution should be taken to prevent the washing out of the earthy material from behind the pavement through the crevices. To prevent this a layer of small broken rock or screened gravel of diameters from 1 to 4 inches should be provided, directly under the pavement. This will be too coarse to wash out through the crevices of the pavement, and will break the force of the water running in and out of the cracks between the paving stones as waves advance and recede. If rock is very abundant, and of poor shapes to form a suitable pavement, it may be dumped roughly on the slope without placing by hand, but in such case a greater thickness should be used, and small broken rock or screened gravel should be employed for its foundation as described above.

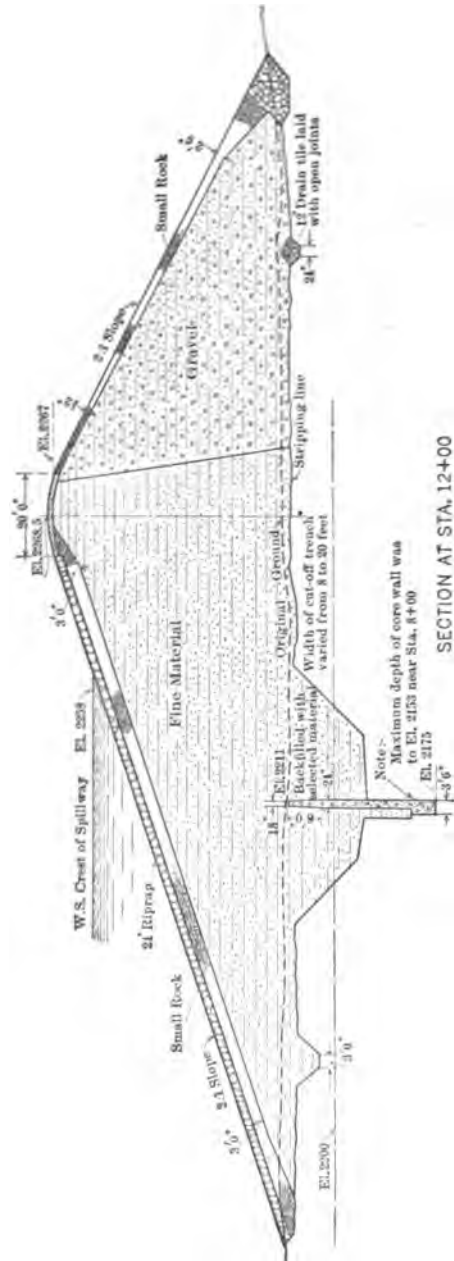

FIG. 199.—Section of Kachess Dam, Yakima Valley, Washington.

Where rock is not to be obtained at reasonable cost it sometimes becomes necessary to protect the face of the dam from wave action by the use of concrete pavement. This may be made in place on the slope, or may be manufactured in blocks at a more convenient point and placed on the dam as paving blocks. Such blocks should extend at least 10 feet up and down the slope, and may be any convenient width in the other direction. The ample dimension up and down the slope is important, as otherwise in a great storm the receding waves may leave a sufficient hydrostatic pressure behind the blocks to move them if too light, and thus cause a breach in the pavement. Such accidents have occurred in a number of cases in the region of the great plains, where rock is scarce and concrete has been extensively employed for paving dams.

Probably the best form of concrete pavement yet employed is a series of concrete strips, 15 or 20 feet wide, running from the toe to the top of the dam, with vertical joints the entire length of the slope, but no horizontal joints. This pavement should be 4 or 5 inches thick if reinforced, or 6 inches if not. Under each joint, running from toe to top of the dam, should be a concrete sill, about 6 inches square, built into the earthwork and flush with its surface. After seasoning, the upper surface of these sills should be oiled or tarred, to prevent adherence to the concrete slabs afterwards built upon them, and to make a tight joint. This will permit these joints to absorb the expansion and contraction in a horizontal direction, and the vertical movement to be communicated to the top.

Where rock and concrete are very costly and coarse gravel is conveniently available, it may be possible in some cases to depend on using this in great abundance for slope protection, as has been done on the two large embankments of the Deer Flat Reservoir in Idaho.

In these cases, after finishing the dam to a 3 to 1 water slope and 20 feet top width, the top was widened by dumping from cars on the water slope, the coarsest gravel available, which was sand and gravel varying from bowlders of 50 pounds weight through all intermediate sizes to fine sand and silt, the

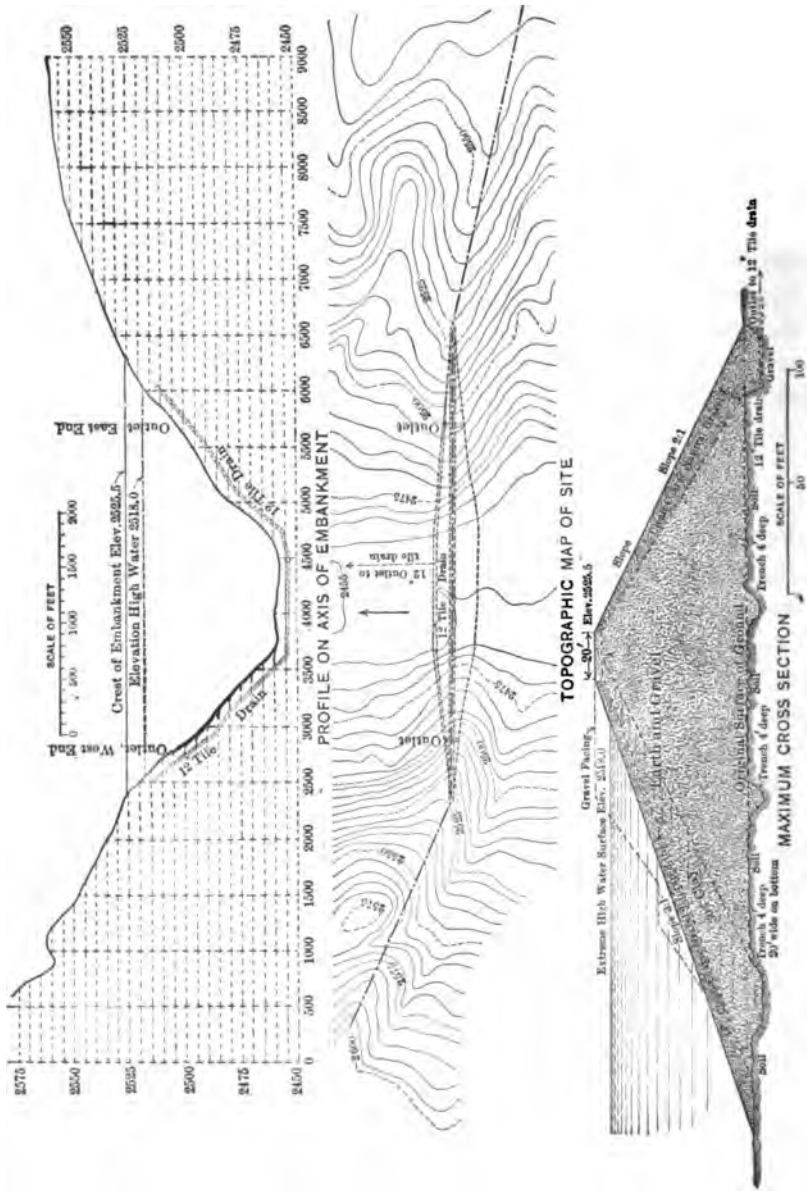

FIG. 200.—Profile, Plan, and Section, Upper Deer Flat Embankment, Boise Valley, Idaho.

proportion of coarse material varying, but never great. In this way the upper embankment received about 95,000 cubic yards of extra material, which took its natural angle of repose and widened the top of the embankment from 20 feet to 51 to 67 feet.

As the waves of the reservoir attack the gravel slope they gradually undermine and cause the gravel to creep down the slope. The finest materials are carried into the lake and slowly deposited, those a little coarser washed down to the toe of the slope, and the other materials are carried down less and less freely as they become coarser. In this way by the automatic sorting of the water, the fine materials are deposited on the bottom of the reservoir near the toe of the slope and serve to make this area more impervious. The coarser sand collected near the bottom serves to give the bank a flatter slope, and the materials, left on the slope become gradually coarser from the bottom upward, and the coarsest cobbles and bowlders are left on the upper part of the slopes in the capacity of riprap, and finally each material will take the slope at which it can resist the wave action, resulting in a flattened slope paved with water-selected coarse material of gravel and cobbles. Experience so far indicates success for this experiment, with a large saving over the cost of paving the slopes with concrete.

f. Percolation.—The flow of water is ordinarily due to a slope in the water surface. The action of gravity causes it to move from the point where its surface is highest, toward the point where it is lowest. This is true of a stream, or a lake, and is equally true of underground waters. The resistance to flow by the materials of the soil is very great, so that subterranean waters move very slowly, and their movements are further complicated by capillary action, but gravity flow depends upon slope, and will not occur without slope.

The rate of transmission of water through any given soil varies with the sine of the angle which the surface of the percolating water makes with the horizontal. It also varies with the size of the interstices in the material traversed. Clay, for example, may have and usually does have, a larger percentage



FIG. 201.—Owl Creek Dam, near Belle Fourche, South Dakota, Showing Concrete Paving.



FIG. 202.—Upper Deer Flat Embankment, Showing Beaching of Gravel slope.

of voids than sand or gravel, but they are so minute that percolating water is greatly retarded by friction, and moves very slowly, and for this reason clay is regarded as the best earthy material to resist the passage of water.

After long and careful investigation Slichter gives the rate of flow for a grade of 10 feet per mile, in various materials as follows:

TABLE XXXVII

Material	Miles per Year	Velocity Feet per Year
Fine sand.....	0.01	52.8
Medium sand.....	0.04	216.0
Coarse sand.....	0.16	845.0
Fine gravel.....	1.02	5386.0

The more minute the openings through which the water must pass, and the greater the friction of passage, the greater must be the slope necessary to induce a perceptible motion. Well-compacted clay presents great resistance to the passage of water, and is therefore very desirable as a leading element in the upstream half of the dam.

Since we cannot make an earthen bank entirely tight, it is important to make it so nearly so that the slope of percolation of water from the reservoir will be steep, and will reach the ground before it reaches the lower toe of the dam, so that the downstream slope of the dam will not become saturated and induced to slough. For this reason it is desirable that the entire upstream half of the dam be made as tight as practicable, and for the same reason, some relief in the downstream half is desirable. This may be obtained by making this portion of the dam of coarse material, as coarse sand or gravel, which will allow small quantities of percolating waters to escape freely without danger of erosion. The same result may be obtained by installing under-drains about the center of the lower third of the foundation. These methods of relief, however, should not be permitted, unless reasonable tightness is sure to be

attained in the upper half; for if spaces of any size occur in the fine material, the free escape provided may permit erosive velocities, which by enlarging the channels, may cause disaster.

Fragments of quartz or granite of which sand and gravel are often composed, are practically impervious, and large fragments of such material in an earthen mass tend to make it impervious provided the spaces between such fragments are properly filled.

Following the above principles to a conclusion, we find that the tightest mixture we can make consists of large fragments of impervious gravel, with enough smaller fragments to fill the space between, and still smaller fragments to fill the space between these, and so on, ending with the finest clay. The author has observed some mixtures in nature that proved to be remarkably water-tight under considerable pressure, two of which were shown by mechanical analysis to be graded as follows:

TABLE XXXVIII

Material	Passing	Held on	Percentage	
			No. 1	No. 2
Gravel.....	2-inch sieve	8.7	15.3
Gravel.....	2-inch sieve	1-inch sieve	9.4	9.0
Gravel.....	1-inch sieve	No. 4 sieve	44.5	43.1
Sand.....	No. 4 sieve	No. 20 sieve	18.4	17.1
Sand.....	No. 20 sieve	No. 50 sieve	5.1	4.8
Sand.....	No. 50 sieve	No. 100 sieve	1.4	.5
Sand.....	No. 100 sieve	No. 200 sieve	1.4	.1
Clay and silt.....	No. 200 sieve	11.1	10.1
Total.....	100.0	100.0

Sample No. 1 was taken from near St. Mary Lake, Flathead Reservation, Montana, and No. 2, from near Lake Kachess, Washington. In each case the samples were taken from the sidewalls of test pits in the immediate vicinity and far below the water in the lake, and were so tight that practically no leak was noticeable. Both samples were from glacial moraines,

unstratified, and thoroughly mixed. Classifying the material as gravel, sand, and fine material corresponding in size to Portland cement (taking for this purpose all the material passing the 100-mesh sieve) we have:

TABLE XXXIX

	Sample No. 1, Per Cent	Sample No. 2, Per Cent
Gravel, held on sieve No. 4.....	62.6	67.4
Sand, held on sieve No. 100.....	24.9	22.4
Fine material passing No. 100.....	12.5	10.2

In combining such materials for the purpose of producing a tight mixture, it is well to add some excess of the finest materials, rather than run any risk of leaving unfilled voids between the coarse ones. The ratio of 1:2:5 corresponds almost exactly with sample No. 1, and if we allow for the small percentage of clay and fine silt usually occurring in natural sands, we have nearly the percentages of cement, sand and gravel found in good concrete, which is also designed to be nearly impervious.

This mixture can be further improved by increasing the percentage of coarse gravel to near the maximum that can be used and still have the voids well filled by finer material. Experiments show that the amount held on the 2-inch sieve can with advantage constitute fully half of the mixture when the parts are measured separately. The size, shape and relations of the different sizes are so indefinite and so variable in practice that no exact rules can be adopted with profit, but the following proportions constituted a rough guide:

Coarse gravel, held on 2-inch sieve.....	1.00	cu.yd.
Fine gravel, held on No. 4 sieve.....	.35	“
Sand, held on No. 100 sieve.....	.40	“
Clay and silt, passing No. 100 sieve....	.25	“
Total.....	2.00	“

These proportions, when well mixed and compacted with a small quantity of water and rolled, can be reduced to about

1½ cubic yards in bulk. Such a mixture can rarely be obtained in practice, but it gives the maximum weight and stability, as well as water tightness.

Much discussion has been held in the past regarding the merits of the various types of earthen dam mentioned, especially between the partisans of masonry corewalls as against those opposing such walls. Both types have their uses, depending on the local conditions. A wooden or plank core should never be employed, as this is sure to decay, and both before and after decay it affords a convenient path along which leakage water may freely travel and find an outlet if any exists.

A central core of puddled earth is advisable only when material suitable for such puddle is too scarce and expensive to permit the upstream third or half to be so composed, which is better when feasible.

A masonry corewall affords excellent facilities for making connection with the outlet conduit, with rock foundation or abutments, and with masonry extensions or other structures. The corewall may be necessary in cases where no impervious earth is procurable, or where it contains a considerable percentage of soluble salts, so that percolating water might in time carry out in solution enough salts to leave the mass pervious and unsafe. Such a case was the Avalon Dam on the Pecos River in New Mexico, built by the Pecos Irrigation Company, which failed in 1904, without overtopping. The most plausible explanation, being the gradual leaching of the sulphates of calcium and magnesium, until a finely honey-combed condition was reached after which a slight concentration of the leakage, afforded openings permitting destructive velocities, and disaster followed. In the reconstruction, a corewall of concrete was used in the new portion, and the remnant of the old bank was provided with one of steel sheet-piling. These have now been in successful service over ten years.

Where these special reasons for a corewall do not exist, the tendency for it to produce supersaturation of the upper slope of the dam is objectionable and it also interferes with the best consolidation of the interior of the embankment.

The most general practice in dam building in America inclines to type 2, where great effort is put forth to make the upstream portion of the dam tight with selected material carefully placed and compacted, and building the downstream portion of coarser material, affording drainage, and having less tendency to slough when saturated. Frequently this plan is supplemented by providing a corewall of rubble or concrete, to insure against erosive velocities and to guard against the ravages of burrowing animals. The latter provision is most important where frequent inspection of the slopes of the dam cannot be assured.

Where clay is the only material available for construction, a very good structure can be secured by building it homogeneously in thin layers, moistened and thoroughly rolled. It is important that the moisture added to clay be merely sufficient to permit compacting, as any excess of water in clay carries a tendency to flow, and also causes swelling which may lead to cracking as the water is withdrawn. The embankment being thus finished nearly dry, any absorption of water from the reservoir will tend to swelling and to make the structure tighter. Such a structure is the Owl Creek Dam of the U. S. Reclamation Service near Belle Fourche, South Dakota.

A novel method of preventing the saturation of the downstream half of an earthen dam has been employed in the design of the dam built at the outlet of Sherburne Lake on Swift Current Creek in northern Montana. At this site it was not practicable to obtain clean gravel in sufficient quantity for the downstream slope to obviate the danger of sloughing if the material were saturated with water. To prevent seepage from reaching this portion of the dam by percolation through the upstream half, a core was placed about midway of the location, not of concrete or puddle, to stop the water, but of screened gravel to receive and conduct it freely downward to a system of drain pipes through which it could drain into the stream below the dam without coming in contact with the dam below the core at all. This provision seems to have accomplished its purpose perfectly.

g. Methods of Construction.—The materials for constructing an earthen dam may be excavated and transported to place in various ways. Where sand, clay or loam or their combinations occur near the dam site, one of the commonest and cheapest methods is to plow and load it into dump wagons by means of elevating graders, drawn by horses or by traction engines. This method is well adapted to localities where the soil is shallow and underlain by rock. The dump wagons, drawn by horses, deposit the earth while in motion, and additional spreading is accomplished by road graders or Fresno scrapers.

Where the material occurs in deep deposits so that a face of 10 feet or more can be obtained, steam shovels may be employed to load it into dump wagons or cars in which it is transported to place. Where the earth is transported in cars, it is often best to carry it to place on the dam on a track laid on the embankment, and moved back and forth as the work progresses. Sometimes when the abutments of the dam are steep, it is necessary to build a high trestle along or parallel to the axis of the dam, and dump the cars from a track built on this trestle. The cross braces of the trestle should be removed as the bank rises, as they otherwise would furnish routes for the lateral passage of water, and thus encourage leakage. The vertical members offer no such menace, and it is necessary to leave them in place. Material dumped from trestles is transported to its place in the dam by means of scrapers, and may be further spread and leveled, with road graders. Before sprinkling or rolling it is best to remove all rocks more than 4 inches in diameter, from the body of the dam, as these may prevent the proper action of the roller, and leave uncompacted spots in the bank. All such rocks are valuable parts of the bank, and are most useful on the upper and lower slopes, where they serve to protect the dam against the elements and are also valuable as an influence against sloughing.

If further mixing is required, it may be secured by the use of a common two-horse cultivator equipped with 4 or 6 shovel plows, like that used for cultivating row crops.

After the spreading and mixing is accomplished it is generally necessary to sprinkle with water in order to prepare the material

so it will "pack." This may not be necessary in wet weather, or in a moist climate, but usually is in regions where irrigation is practiced. The cheapest method of sprinkling is to lay a 3 or 4-inch pipe along the edge of the embankment, into which the water is forced under pressure by a pump, or by gravity if practicable, and then attach hose to branches of this pipe at frequent intervals, from which the layer of earth is sprinkled preparatory to rolling. Care should be taken to apply the water uniformly, so that dry spots will not be left imperfectly



FIG. 203.—Wheeled Scraper.

compacted, and if considerable clay or loam occurs in the material, the water applied should be only that required to make it pack, as an excess of water causes swelling of clay, and may cause a boggy condition which will give trouble in rolling. When a bank of clay is thus built, nearly dry, any further absorption of water causes some tendency to swell and thus further compact the material and increase its tightness.

The compacting should be accomplished by spreading in layers 5 or 6 inches, sprinkling and rolling with a traction engine, or other suitable roller.

Grooved rollers drawn by horses are often used, and the common road roller is sometimes employed, but neither of these give as good results as a heavy traction engine, driven longitudinally along the embankment. It may be advisable to provide such an engine with steel tires to widen the tread, but one of its chief virtues is the fact that it does not leave a wide, smooth plane, as does a road roller, but rather compresses the earth in a series of grooves, and it also concentrates greater weight on each spot at one time.

h. Hydraulic Fill.—Under some circumstances it is economical to excavate and transport the material to place in the dam by means of water. Very good results may be obtained by this method properly carried out. To do this it is necessary to have water under heavy pressure, so that delivered through a nozzle a stream can be projected with sufficient force against the material to be excavated, to loosen and carry it away. This is then transmitted through pipes or flumes to its place in the dam. The necessary pressure to produce a cutting jet of water may sometimes be secured by diverting a stream at a higher elevation and bringing it in a ditch or flume to the vicinity of the dam site, from 100 to 200 feet above the deposit of material to be excavated, so as to provide the necessary head by gravity. The water is then confined in pipes and conducted to the barrow pit where a hydraulic monitor with movable nozzle projects it with force against the material to be excavated.

Where the conditions do not permit the method above described, the necessary head may be obtained by means of large pumps pushing the water through pipes of ample capacity, at a velocity sufficient to cut and carry the material from the barrow pit. If, then, it is necessary to elevate the material to place it in the dam, other pumps may be installed and the material mixed with water may be pumped through pipes and deposited where required.

Where the hydraulic method of transportation is used, it is necessary to build dikes at the upper and lower faces of the dam, and discharge the water laden with solid material between them.



FIG. 204.—Cold Springs Dam under Construction, Umatilla Valley, Oregon.



FIG. 205.—Grooved Concrete Roller.

where the solid matter is settled and the water drawn off nearly clear. Where the material sluiced is all or mainly clay, it is slow to settle, and remains in a liquid or semi-liquid condition for a long time. It is then necessary to keep the retaining dikes strong and heavy, in order to sustain the heavy side-pressure of the mobile core.

Where the material to be sluiced is mostly clay, a serious problem is presented of draining the sluiced material. The clay holds on to the contained water with great tenacity, and when saturated, assumes a semi-liquid character which exerts a hydrostatic pressure on the retaining dikes which may become greater than their powers of resistance. The pond of water constantly maintained on top of the fill is apt to keep the mass of clay

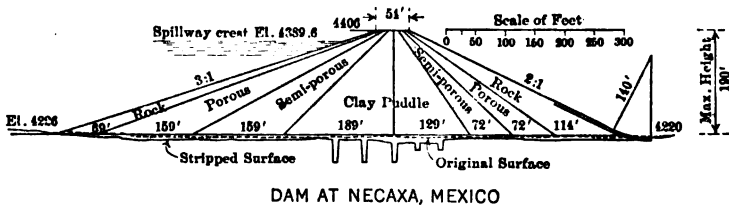

FIG. 206.

saturated, and in some cases the lateral pressure of the mobile clay has broken the dikes and caused slips. Two notable accidents of this kind have occurred with very high dams, under circumstances so similar as to attract widespread attention and comment. The cases were the Necaxa Dam in Mexico, and the Calaveras Dam in California.

At Necaxa the design of the dam was such as to give two embankments of porous material, largely rock, resting upon a central embankment of clay, the latter having theoretical side slopes of 1 to 1. The base width of the outside embankments composed of rock and sand, was about 350 feet on the upstream side, and 250 feet on the downstream side, leaving for the central core a base width of about 365 feet. The outer slope of the upstream bank was 3 to 1, and that of the downstream bank 2 to 1.

The theory of the design was that, as the rock embankments advanced in height and rested upon the clay, they would aid in forcing the water out of the clay by the superimposed weight, so that the portion of the clay underlying the rock at least would become hard, while the center would harden later as the weight of the clay increased. The materials were used in about the proportions they occurred in the pits.

Owing to construction difficulties the progress of the upstream embankment fell behind, and was frequently left very narrow, the place being filled with clay. This defect persisted at a certain point near the center where the sluicing flumes from the two sides should have met but did not, leaving this part of the rock very thin for a considerable elevation, and at this point the break occurred. The clay suddenly burst through the bank and flowed out into the reservoir to the quantity of about 720,000 cubic yards. Also the defective bank was largely composed of an eruptive rock having a specific gravity of only about 1.8, whereas the downstream bank was largely of limestone with a specific gravity of 3 or more. The reservoir was empty at the time of failure.

The Calaveras reservoir contained a depth of 55 feet of water at the time of the slip, but in other respects there was a strong similarity of conditions as shown in the following tabulation from the *Engineering News-Record*:

TABLE XL.—TWO EARTH DAM SLIPS

	Necaxa	Calaveras
Yardage of completed dam.....	2,130,000	3,085,000
Yardage in place.....	1,926,000	2,800,000
Percentage complete at slip.....	90.4	90.7
Length of gap, feet.....	390	700
Length of dam, feet.....	975	1300
Approximate height of slip, feet.....	172	170

The similarity of yardage in the two slips, notwithstanding the longer gap at Calaveras, was due to the fact that no material below the level of the water in the reservoir moved.

At the Calaveras dam a movement of the upstream dike occurred on June 18, 1917. Sluicing was immediately stopped and the movement continued at a decreasing rate for three days and then stopped, the total movement being between 2 and 3 feet. Sluicing was resumed on July 7, and continued for 12 days, when movement was again noticed and sluicing was stopped. The steam shovel work on the dikes was continued, however, and each dike widened 60 feet into the pool and raised 30 feet or so. The central core of liquid clay was raised 12 feet by the sinking of the rock-fill into it. On February 12, 1918, sluicing was resumed, and again stopped on March 4, on account of further movement, which continued irregularly until March 24 when the failure occurred as a sudden movement. The upstream dike broke and the liquid clay flowed out into the reservoir, overturning and burying the outlet tower. These two accidents, as well as small slips at the Gatun Dam and elsewhere, emphasize the importance of providing self-sustaining stable dikes to confine sluiced clay, during the very slow hardening process.

Where the material sluiced into the dam contains coarse elements, as gravel or rock fragments, it is desirable to deposit this on the slopes of the dam, and the finer material in the interior, where it will form a tight puddle core. The coarse material placed on the water slope will, if sufficiently coarse and abundant, protect the dam from the destructive action of the waves, and that on the lower slope will protect it against the erosion of wind and rain, and on both slopes will guard against sloughing. The entire body of the dam being of sluiced material settled in water will, if properly constituted and disposed as above described, form an ideal structure in stability and efficiency for its purpose. Fig. 207 illustrates the method of transporting mixed materials and disposing them as above described. Parallel flumes are built lengthwise of the dam, which receive the materials brought from the pit. These flumes are provided with gates on both sides that can be opened and closed at will, and at the point where it is desired to discharge the load, an iron screen or grillage with openings large

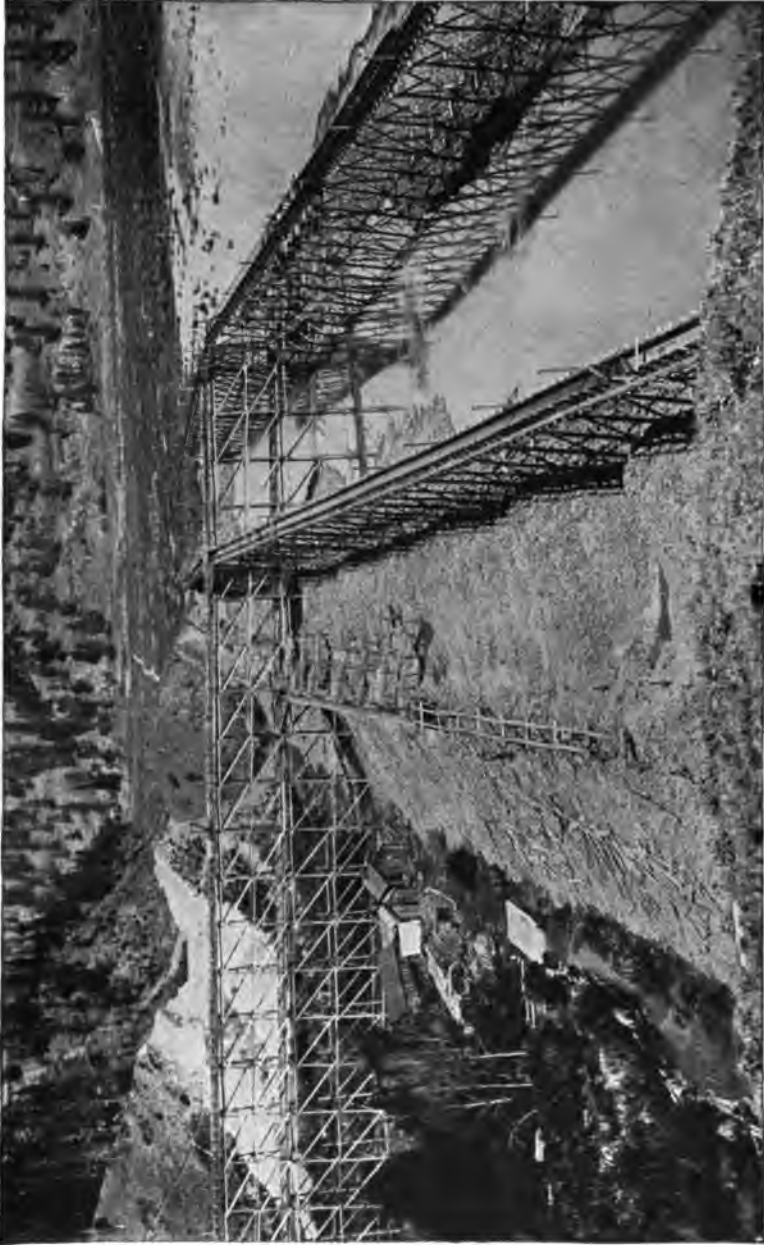

FIG. 207.—Trestles on Conconully Dam, Washington, showing Method of Hydraulic Construction.

enough to pass most of the sluicing materials, but small enough to stop the coarsest, is placed in the flume at an angle of about 45 degrees, just below an open gate on the side of the outer slope of the dam, and this grillage deflects the coarse material which falls on the slope, while the water carrying the finer material rushes through and is discharged on the inner side into the central pond. As it falls, the coarsest of the material is deposited, and the water, no longer confined to a narrow channel, can carry only the sand and clay. As the slope flattens the sand is deposited, the coarsest first, and the fine nearer the pond, while the clay and impalpable silt is carried into the pond, and settles but slowly. A weir is provided where the surface water is drawn off at a point as remote as convenient from where the water enters the pond with its load of silt. There is always a tendency to stratification in the central pond, and due precaution must be taken to prevent continuous strata of sand from extending through the puddle core, as this would furnish an opportunity for the passage of water. Such strata may be broken up by men wading about in the pond, and plunging boards or paddles into the mud as far as possible in such a position as to cut the strata and permit the deposit of clay in the cavities made by the paddles.

Hydraulic methods are best adapted to mixed materials, as the sorting capacity of water can be utilized to separate the different sizes and produce outer slopes of rock or gravel, which have no tendency to slough, and will resist the action of waves on the water side and the wind and rain on the other. The finer material can thus be concentrated in the center, where if it contains considerable loam or clay it forms a puddle core and imparts a water-holding capacity to the structures.

Sometimes it is found desirable to excavate and transport the material to the dam by dry methods, deposit it in dikes along both faces, and then wash a portion of it into the center with a hydraulic jet, forming a pond in the center and producing a puddle core. This combination of hydraulic and mechanical methods is best adapted to localities where the material is a mixture of coarse and fine, with many rocks too large to be

transported with water or consolidated with a roller, and too numerous to be rejected.

Except where the hydraulic method is used, it is best to put the finest and most impervious material near the water face, and if enough of this is readily available, one-half or two-thirds of the dam should be so built, leaving the lower third to be built of gravel or other coarser material, grading from fine to coarse as gradually as convenient, so that the coarsest material used is on the downstream face.

The transition from fine to coarse material should be as gradual as possible, however, to prevent any tendency for percolating waters to carry the fine material through the gravel. The ideal condition is analogous to a filter, where a very fine material is employed on the water side and becomes very gradually coarser in the direction of the flow of water. The voids being

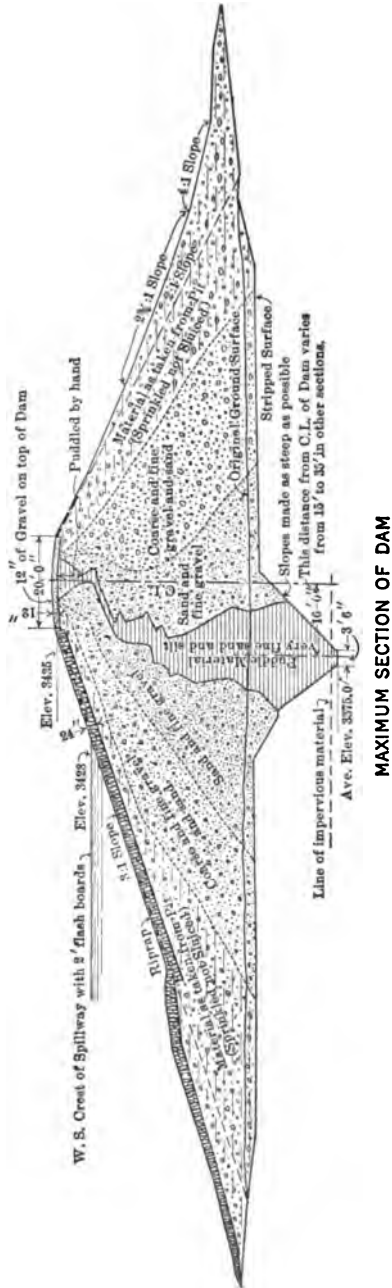

FIG. 208.—Cross-section of Bumping Lake Dam, Naches River, Washington.

everywhere too small for the passage of the finest particles of earth in their vicinity. At least one-third, however, and better still one-half or two-thirds of the dam on the water side, should be made as tight as possible. There is decided advantage, however, in having the downstream part of the dam composed of gravel, as this has no tendency to slough when wet, and it is practically impossible for percolating water to erode channels through gravel, as it will not bridge over like clay or loam, but will generally fall into any cavity formed and clog it. It thus offers ready and safe drainage for any waters that may percolate through the upstream part of the dam, and prevents saturation of the interior, with its tendency to slough. For

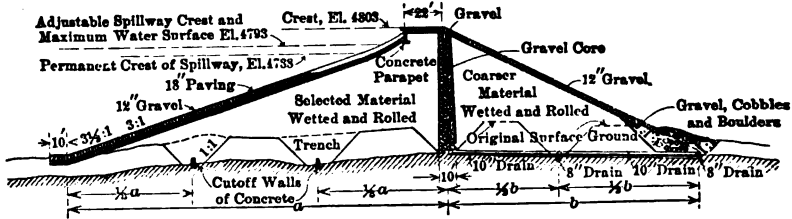
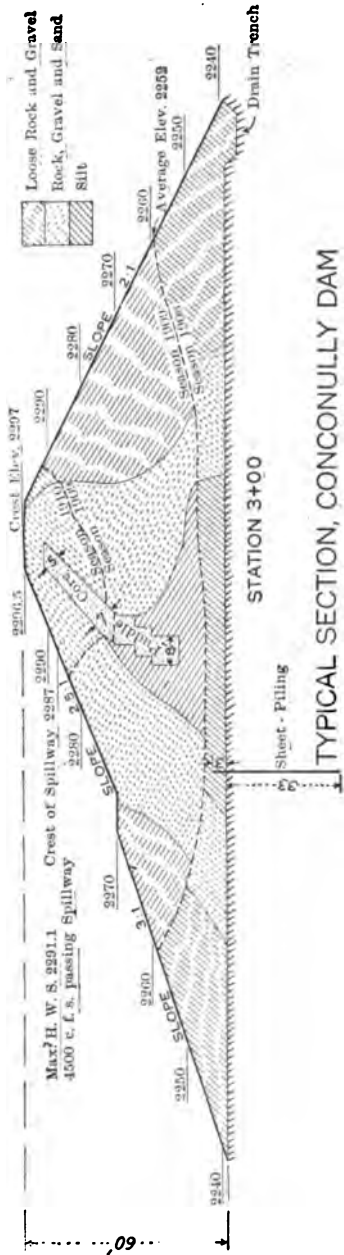
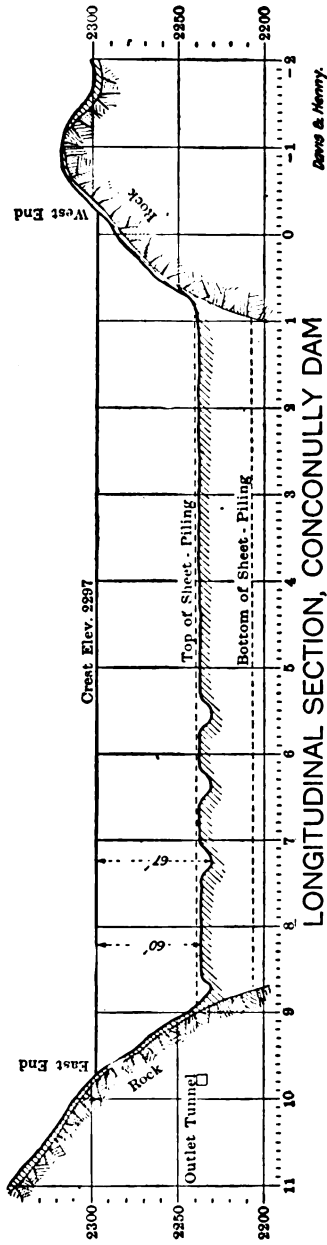

FIG. 209.—Section of Sherburne Lake Dam, showing Gravel Core and Drains to Provide for Seepage Water.

these reasons, gravel is a very valuable building material for dams, canal banks, and many other irrigation requirements. Even the impervious portion may be, and preferably should be largely of gravel, as we have seen, although it requires an admixture of finer materials to make it tight. An advantageous use of gravel in an earthen dam is illustrated in Fig. 209. In this case it was difficult to obtain sufficient gravel to form the entire downstream half of the dam, and so a core of screened gravel 10 feet thick was placed in the axis of the dam to receive any water that might percolate through the upstream half of the dam and conduct it readily to the base, where it is carried away by tile drains. This is to prevent the saturation of the lower half of the dam and the consequent tendency to slough. The screening of the gravel was for the purpose of removing



TYPICAL SECTION, CONCONULLY DAM
SHOWING DEPOSITION OF MATERIAL BY SIZE



LONGITUDINAL SECTION, CONCONULLY DAM

Fig. 210.—Sections of Conconully Dam, Salmon Creek, Washington.

any sand which would tend to clog and render the drainage imperfect.

Fig. 196 illustrates another use of gravel, on the lower toe of the Owl Creek Dam. This gravel was hauled a long distance, and placed in position to load the foundation at the lower toe, where seepage under the dam might soften the earth. The gravel prevents any tendency to slough, while allowing seepage waters to escape harmlessly.

4. **Rockfill Dams.**—The rule that earthen dams should be built of material fine and water tight on the water face, and grade very gradually into coarser material toward the down-

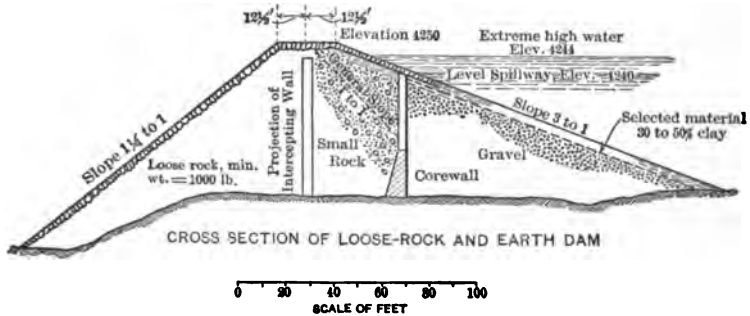

FIG. 211.—Rock-Fill Dam, Snake River, Minidoka Project, Idaho.

stream face, suggests a combination often employed, of earth and rock-fill, where earth is used on the side toward the reservoir, and loose rock on the other side. The transition, however, should be as gradual as possible, to prevent any leakage from washing the earth through the rock-fill and causing a breach. If suitable earth is plentiful near by, it is much cheaper to place than the rock, and will naturally predominate, but where it is scarce, or must be transported a long distance, economy may require the use of rock in the main body of the dam, with only enough earth to form a water-tight blanket on the water face. Where insufficient earth for this purpose is available, it becomes necessary to secure water-tightness by other methods, and we have the rock-fill type, pure and simple.

Where a dam is built of loose rock, it is necessary to employ some special measures to secure water-tightness. This is some-

times obtained by providing a deck of lumber on the water face, carefully caulked and fastened to timbers built into the rock. The lumber deck should be liberally treated with asphalt or

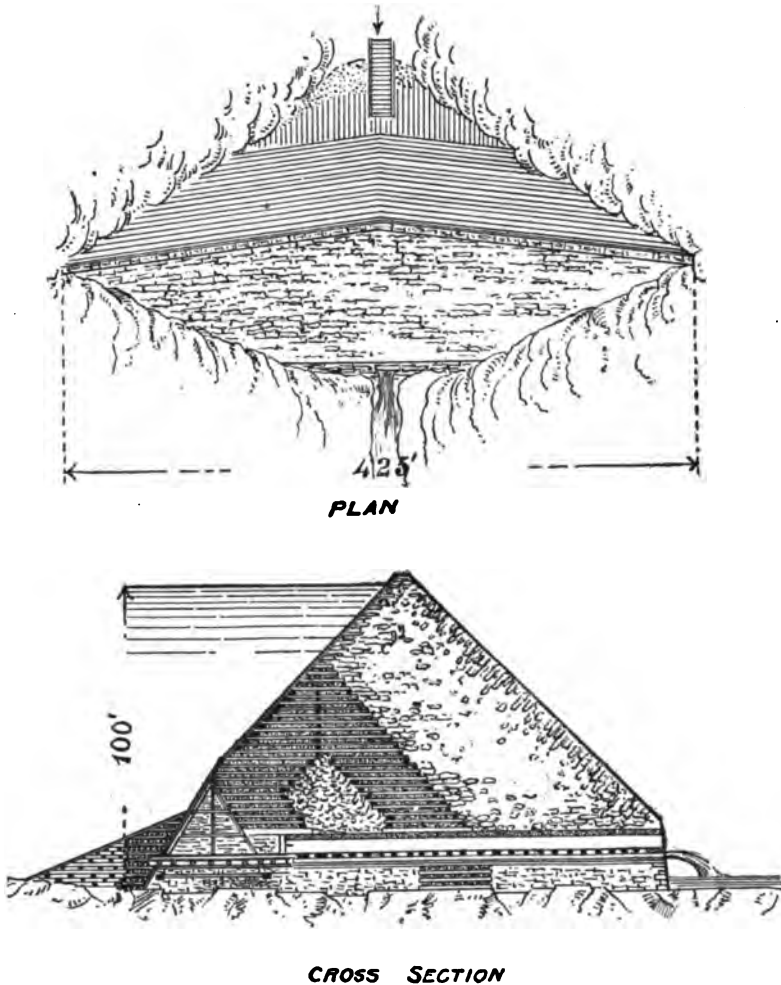

FIG. 212.—Plan and Cross-section of Bowman Dam.

durable paint to preserve it from warping and deterioration, and it should be inspected and repaired whenever the water is drawn out of the reservoir.

Steel has also been employed to form a water-tight deck on a loose-rock dam, and serves the purpose well if protected from oxidation. It must have frequent expansion joints to provide for changes in temperature.

In some cases a corewall of masonry is built in the center to secure water-tightness, and in one case, the lower Otay Dam in Lower California (Fig. 214) a diaphragm of steel was employed in conjunction with the corewall. This diaphragm was one-third of an inch thick near the base, and one-quarter of an inch

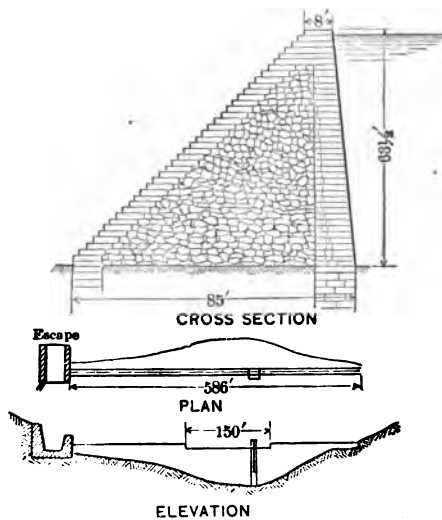

FIG. 213.—Elevation, Plan, and Cross-section of Castlewood Dam, Colorado.

in the upper part. It was anchored firmly to the masonry foundation, and coated with asphalt applied hot. A layer of burlap was applied to the asphalt while still hot, and over this a harder grade of asphalt was applied, and the whole was encased in a rubble masonry wall laid in Portland cement concrete. This wall was 6 feet thick at the base, tapering to 2 feet at the height of 8 feet, which thickness was maintained to the top.

The top width of the dam was 12 feet, and the rock was dumped in place with face slopes about 1 to 1. The dam was 150 feet high above the bottom of foundation, and 565 feet long



FIG. 214.—Lower Otay Rock-filled Dam, California.

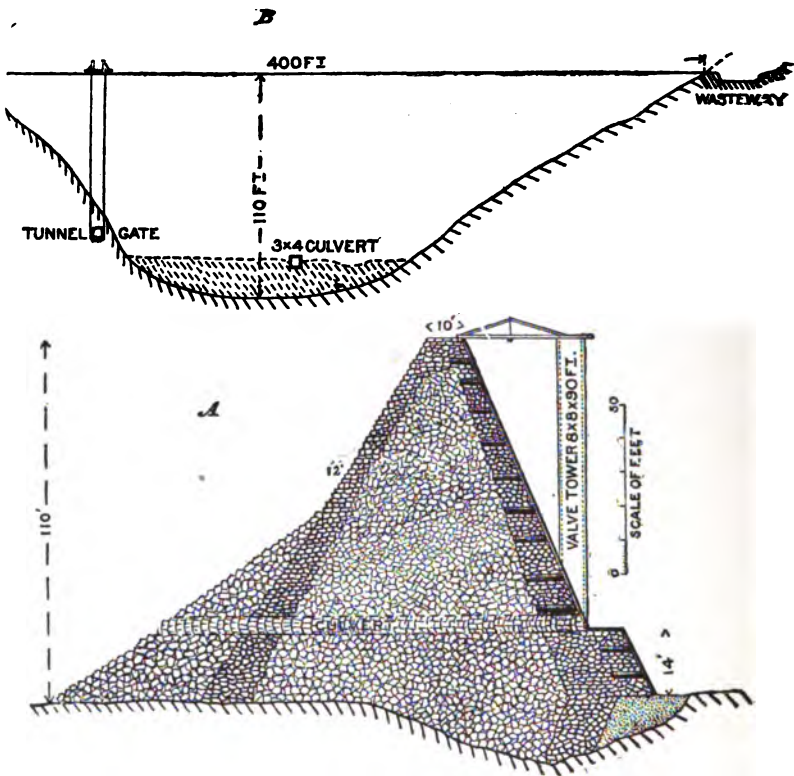

FIG. 215.—Elevation and Cross-section of Walnut Grove Dam.

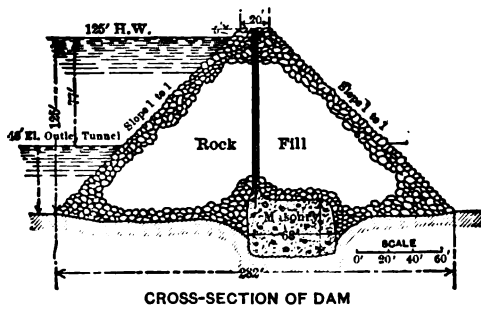

FIG. 216.—Rock-filled Steel-core Dam, Lower Otay, Cal.

on top, forming a reservoir of 42,000 acre-feet capacity. A few hundred feet east of the dam a channel was cut through the rock, 30 feet wide, to a depth 10 feet below the crest of the dam, to form a spillway. This proved to be insufficient, and in the great storm of January, 1915, the reservoir filled and the dam was overtopped by the flood and destroyed. The drainage area is about 12 square miles, and the capacity of the spillway about 5000 feet per second, with water standing even with the crest of the dam.

The Walnut Grove Dam in Arizona is another case of a rock-fill dam that was washed out by overtopping of the structure by a great flood wave. These failures do not condemn the rock-fill type of construction, but emphasize the importance of providing abundant spillway capacity so that by no possibility can the dam be overtopped by flood waters. For similar reasons it is desirable that the largest and best rocks obtainable be placed at and above the downstream toe of the dam, to resist any excessive leakage that might accidentally occur. When properly built of good, sound, durable rock, and supplemented by an ample spillway, the rock-fill type of dam has no superior for safety and permanency, and has, indeed, some apparent advantages in resisting earthquake shocks.

CHAPTER XVIII

MASONRY DAMS

MASONRY DAMS may be classified with reference to their materials of construction into four main types:

1. Coursed masonry, or cut stone laid in cement mortar.
2. Rubble masonry, or rough uncoursed stone laid in cement mortar or concrete.
3. Cyclopean concrete or concrete with large stones or "plums" embedded therein.
4. Plain concrete.

Where rock is of best quality, coursed or ashlar masonry will require the minimum quantity of cement, and will also afford the maximum weight and resistance to crushing, since this type employs the maximum proportion of stone and the minimum of mortar, and first-class stone is both heavier and stronger than any mortar or concrete that can be made.

By reason of the courses it is less firmly bonded together than other types of masonry, and may have therefore less shearing strength along horizontal courses. The work of shaping the stones also involves expense, and for these reasons ashlar masonry is not often used unless cement is very costly or a good appearance is especially desirable.

Rough uncoursed rubble requires more cement, but unless cement is very costly is generally cheaper than ashlar because of less labor involved, and its random character and use of very large rock bind the dam together into a monolith, and thus give it greater shearing strength, with less tendency to crack. This type is much used and is very desirable and economical where good rock is abundant. The stones are usually embedded in cement mortar, while concrete may be used to fill vertical joints.

Cyclopean concrete has large and small rock embedded in it, and differs from rubble mainly in the fact that the former uses rock to a greater extent, while in the latter concrete predominates. It requires less manual labor, and is cheaper under most circumstances, while giving very satisfactory results. It is now more generally employed than any of the other types.

The fourth type, Plain Concrete, is used where good rock is not convenient, and gives good results, though not so heavy nor theoretically quite so strong as the other types, unless reinforced with steel.

1. Classification of Masonry Dams.—Dams built of masonry may be divided into two classes according to their design:

1. Gravity Dams, or those depending for stability entirely upon their weight.
2. Arch Dams, or those depending for stability mainly upon their action as an arch, by which the water pressure is transmitted to the abutments.

There are many instances of dams in service that would instantly fail under water pressure if weight were the only dependence for stability. They are curved in plan, and resist the pressure of water by arch action. On the other hand there are also many dams which are straight and cannot possibly act as arches, and are stable only because of their weight. Since every masonry dam must have considerable weight, this constitutes in every case an important element of its stability, and the two types merge into each other in a very indefinite manner.

Many high dams have been built on gravity lines, theoretically safe as gravity structures, but also curved to form an arch as an added assurance of stability. Intermediate types with scant gravity section but arched in plan, and others of gravity section and only slightly curved have also been constructed.

Some curvature of plan is always desirable in every masonry dam, and should be provided unless the expense is excessive. Whatever its coefficient of safety as a gravity structure, this can be increased by curving the plan, so that the dam can

neither slide nor overturn without crushing the masonry or its abutments. This precaution does not prevent nor interfere with the stability due to gravity and cohesion, and only comes into play to supplement them in case they prove insufficient, and the arch action takes only those stresses which are beyond those provided for by gravity.

2. Methods of Failure.—A masonry dam may fail by any one or more of three methods:

- (a) By sliding on the foundation or on any horizontal joint.
- (b) By overturning around the downstream toe or any part of the downstream slope as a fulcrum.
- (c) By crushing the foundation or the masonry.
- (d) By undermining the foundation, either by backlash of water pouring over the top, or by piping underneath the dam by water under pressure.

Failures sometimes occur by a combination of the above causes. For example the excavation of a deep hole by water falling below the toe of a dam on a weak foundation may remove the supporting rock to such an extent as to cause failure by sliding or overturning, which might not have occurred had the toe been properly protected.

A masonry dam generally has an indefinite but important element of strength due to the cohesion of its parts, if care be taken to make it of monolithic character. This is an added security especially against failure by sliding on a joint of the masonry, as this also involves in that case the shearing of the monolith along that joint. This applies especially to gravity dams, the monolithic character being not quite so important in arch dams, which cannot fail without crushing the masonry or abutments, except by undermining.

3. Pressures in Masonry.—One of the first questions arising in the design of a high masonry dam is the safe limit of pressure in the masonry and in the foundation. There are really two questions requiring careful consideration, namely, the bearing power of the natural rock in place, and the crushing strength of the concrete. If the foundation is a good quality of lime-

stone, sandstone or crystalline rock, it will sustain a greater pressure than any concrete, and the problem is reduced to the question of safe pressures on concrete, as this must in the base sustain substantially the same pressures as the foundation. If, however, the rock is one of the numerous varieties of soft rock or shale it should be carefully tested for its bearing power. This may be done by carefully smoothing a measured portion of the rock in place, building a concrete block upon it, and loading this with steel rails or other heavy material to an amount greater than the load it is desired to have it carry in the construction. Any subsidence should be carefully noted, and the experiment should be repeated on various parts of the rock in question, especially if it appears to vary in quality. Weak zones are to be feared most near the toe of the dam, and next to this in importance is that at the heel. The interior parts of the foundation have less maximum load, and are confined so thoroughly that they will sustain higher pressures. If tests of rock near the toe show notable yielding under the load to be imposed, the limits of pressure must be lowered by spreading the base or otherwise, until they can be safely carried by the material available.

The safe bearing loads for natural rock is a very broad subject upon which much has been written and many experiments have been made. Many elaborate formulæ have been proposed for computing the bearing power of various natural soils, but the impossibility of accurately defining the properties of the many variable materials prevents any exact mathematical treatment of the subject. For the same reason it is difficult to formulate any but rough rules for guidance.

Pure clay is poor foundation wherever it is subject to saturation, as it becomes plastic when wet, and unless thoroughly confined when in that condition, has little bearing power. If well compacted, and heavily loaded, it excludes the water to such an extent that it will safely sustain a pressure of 4 tons per square foot.

Sand has safely carried loads of from 4 to 5 tons to the square foot, and gravel will carry still more. Soft rock and shale have

been safely loaded to the extent of 8 to 10 tons, and harder rocks will carry much heavier loads with safety, reaching in the case of granite a crushing strength of hundreds of tons per square foot. Any good sandstone, or limestone, or any reasonably hard rock has a higher crushing strength than cement mortar or concrete, and hence the safe bearing loads upon masonry, where good rock is used, depend upon the quality of the mortar or concrete with which the masonry is bonded, and the thinner the mortar joints the greater bearing power. For this reason ashlar or cut-stone masonry with thin joints has especially high resistance to crushing.

As concrete is nearly always used in compression, it is important to make crushing tests upon samples to be used in any important structure. These tests are usually made upon 6-inch cubes, or upon cylinders 6 inches in diameter. Any of the standard testing machines are satisfactory for this purpose, and if such are not obtainable, the test pieces may be loaded with pig iron, sacks of cement, or other convenient heavy materials of known weight, or more conveniently, a lever may be used and an equivalent test made with much less weight. It is important that such tests be made to try out the sand and gravel to be used, as these are sometimes unsuitable, without showing any signs of their defects except upon test.

Table XLI gives some pressures of actual service conditions, and some tests to destruction.

Creager gives the following for the compression strength of concrete of various combinations; in pounds per square foot:

Proportions.	Age 1 Month.	Age 6 Months.
1: 2: 4	350,000	470,000
1: 2½: 5	310,000	420,000
1: 3: 6	280,000	380,000
1: 4: 8	230,000	300,000
1: 5: 10	180,000	250,000
1: 6: 12	150,000	200,000

TABLE XLI.—PRESSURES ON MASONRY

Structure	Material	Pressure per Sq.ft. Tons	Authority
Bridge Pont-y Prydd, Wales.	Limestone rubble..	20.7	I. O. Baker
Brooklyn Bridge.....	Granite ashlar.....	39.5	Duryea and Mayer
Washington Monument.....	Cut marble.....	25.4	Col. T. L. Casey
St. Louis Bridge.....	Cut limestone.....	38.0	Hist. St. Louis Bridge
Rookery Building, Chicago..	Cut granite.....	30.0	I. O. Baker
Bear Valley Dam.....	Granite rubble.....	40.0	J. D. Schuyler
All Saints Church, Angers...	Forneaux stone.....	43.0	J. T. Fanning
Chapter House, Elgin.....	Red sandstone.....	20.0	"
St. Paul's, London.....	Portland limestone.	19.7	"
St. Peter's, Rome.....	Calcareous tufa.....	16.7	"
Various Arch Bridges.....	Cut masonry.....	60.0	"
Estacado Hollow-Dam.....	Concrete.....	17.5	"
Vrynwy Dam Prisms.....	Concrete.....	181.0	Tests by Sir Andrew Clarke
Roosevelt Dam, Arizona.....	Quartz rubble.....	23.0	U. S. Reclamation Service
Shoshone Dam, Wyoming...	Concrete.....	21.0	" "
Arrowrock Dam, Idaho.....	Concrete.....	30.0	" "
Elephant Butte Dam, N. M.	Concrete.....	14.2	" "
Kensico Dam, N. Y.....	Concrete.....	15.8	A.S.C.E. Transactions, Vol. 75. p. 170
Olive Bridge Dam, N. Y.....	Rubble.....	15.4	Morrison and Brodie
Burrin Juick Dam, Australia	21.0	Bligh, Dams and Weirs, p. 66
Barossa Dam.....	17.2	" " p. 112
Lithgow Dam.....	13.0	" " p. 112
Granite Ashlar.....	Test specimens.....	583	Austrian Soc. Eng. and Arch.
Sandstone Rubble.....	Test specimens.....	184	" "
Gravel Concrete 1 : 2 : 3.....	Test specimens.....	128	" "
Gravel Concrete 1 : 3 : 5.....	Test specimens.....	66	" "

4. Failure by Sliding.—The number of failures of dams from sliding on their foundations emphasizes the necessity and importance of taking such precautions as to insure against its occurrence. The first essential is to provide the dam with sufficient weight to overcome the tendency to slide with the coefficient of friction to be expected. This coefficient of friction, however, is so uncertain as to be practically indeterminate except very roughly. The difficulty is to learn exactly the conditions that exist in the foundation, and that will exist after construction of the dam. These may vary at any point, and our investigations may be at points not truly representative. Great dependence, therefore, must finally be placed on expert judgment, after weighing all the obtainable evidence. A few simple rules are, however, of value in this connection. The following

values for friction have been published, but should be accepted with caution, because of the impossibility of reproducing the exact conditions:

TABLE XLII.—EXPERIMENTAL COEFFICIENTS OF FRICTION

Materials	Coefficient	Authority
Masonry and brickwork, dry.....	.65	Morin
Masonry and brickwork, with wet mortar.....	.47	“
Masonry and brickwork, on dry clay.....	.51	“
Masonry and brickwork, on moist clay.....	.33	“
Soft limestone on hard, well-dressed.....	.65	“
Soft limestone on soft, well-dressed.....	.67	“
White clay, fine grained, wet.....	.34	Scheidenhelm
White clay, fine grained, moist.....	.42	“
Yellow clay, containing some grit.....	.68	“
Yellow clay, moist.....	.83	“
Yellow clay, very wet.....	.50	“
Black loam, moist.....	.74	“
Black loam, wet.....	.72	“
Black gumbo, wet.....	.71	“

If the foundation is of material horizontally stratified, or nearly so, especial care must be taken to exclude water from the foundation and to afford easy means of exit for any small quantity which enters.

An imperative requirement in the design of a gravity masonry dam is that there shall be no tension in the masonry on the face of the dam which is exposed to water pressure. Should any tension occur here it will tend to form horizontal cracks or to open existing cracks and permit the entrance of water under pressure and thus produce flotation or uplift, which in turn would increase any tendency to slide or overturn the masonry above the cracks. Tension of the masonry at other points while undesirable, is not nearly so dangerous as on the water face. Where conditions permit, one of the surest and cheapest methods of providing an ample factor of safety against sliding in spite of uplift in the foundation, is to build the dam on a curve convex upstream. If this be done, it cannot slide nor

overturn without crushing either the masonry or its abutments. Any good masonry is well-adapted to withstand compressive stresses, and it is on this that reliance should be placed when feasible. It is sometimes urged that with a moderate curve to a long radius the compression on the voussoirs of the arch and the abutments would exceed safe limits. This argument is based on the assumption that all the pressure upon the dam is taken by the arch and transmitted to the abutments. This is impossible. Since it is impossible to deprive a masonry dam of its weight, it has resistance as a cantilever irrespective of its plan, and no strains can be transmitted by the arch to the abutments until the resistance due to gravity and shear have been brought into play. The arch can be made to take only the residue, and if large strains are transmitted to the abutments, it merely emphasizes the necessity of the curved plan, and proves that a straight dam on the same section would be likely to fail.

5. Failure by Overturning.—The tendency of a masonry dam to overturn is in practice less than appears from a theoretical examination of any short section of the dam. The tendency to overturn of such a short section of the dam, if near the center, is met by the necessity of shearing away from the adjoining sections, and the shearing strength of so large a mass of good masonry is very great. The foundation of the dam is usually V-shaped, and the whole dam cannot overturn on the lowest point of the foundation as a fulcrum, and the only line available as a fulcrum for the entire dam is near the top. To overturn around such a line, the dam must rupture on a horizontal plane passing entirely through the dam, the resistance to which would be very great if the dam is well built.

These considerations all add to the security of the dam against overturning over that indicated by the weight of the masonry and the pressure of the water, both of which are definite elements, in which the probable error of calculation is small.

It is significant that our records furnish no instance of failure of masonry dams by overturning, while failures by sliding have been numerous.

6. Miscellaneous Forces.—The above discussion considers merely the water pressure in the reservoir, as resisted by the weight of the masonry. There are many other forces to be taken into account under certain circumstances, which may be at times of considerable importance:

1. Ice pressure.
2. Hydrostatic uplift.
3. Wind pressure.

In tropical and semitropical regions, ice pressure need never be considered, and the same rule applies to the southern tier of States of the United States. But where winter extremes go below zero Fahrenheit, and the reservoir is likely to be full at such times, ice pressure should be considered. In some cases, where reservoirs are used mainly for irrigation, in cold or temperate regions, they are drawn down in the autumn and cannot be entirely filled until the snows melt in the spring, and in such cases ice pressure cannot occur with full reservoir and need not be considered.

Little positive data is available as to actual ice pressures in large reservoirs. Ice forms at temperatures of 32° F. and below, and contracts in volume as the temperature falls. If this contraction produces cracks, they usually fill with water which freezes, forming a solid mass again. When the temperature rises the ice expands, and if confined between rigid bodies, such as adjacent bridge piers, may exert a thrust equal to the crushing strength of the ice, which may vary from a small amount to something like 800 pounds per square inch. In a reservoir with sloping sides, no such stresses can occur, and it is seldom that much allowance must be made for this thrust. Local conditions should be carefully considered in each case.

A precedent often quoted is a recommendation of a board of eminent engineers that an allowance of 43,000 pounds per linear foot be made for ice pressure in the design for the Quaker Bridge Dam. No definite reason was given for this large allowance, and the precedent was not extensively followed.

Ice pressure may be prevented by breaking or cutting it

along the dam when it forms. Its thrust may be minimized by presenting a sloping face to the reservoir at the surface of the water when full.

a. Hydrostatic Uplift.—The most important force to be considered and provided for in addition to the water pressure in the reservoir is the buoyant force of water entering the foundation or the masonry of the dam under the hydrostatic head of the reservoir, with a tendency to lift or float the dam. Since most materials in nature are not perfectly water-tight, but generally contain seams along which water can travel, it is practically impossible to exclude water entirely from the foundation. It is almost equally difficult to construct masonry so perfect in all its parts as to entirely prevent water under pressure from entering the structure to some extent. For these reasons it is necessary to make some allowance for uplift in the design. With the greatest practicable care, it is impossible to determine in advance to what extent uplift will take place in the completed structure. Reasoning thus, some engineers have contended that the only safe course is to assume that the dam will be subjected throughout any horizontal plane to an uplift equal to the entire hydrostatic head corresponding to the depth of water in the reservoir above the surface of the water in the stream below, and that the dam must be made heavy enough to be stable under such conditions.* If such a condition were possible, it would be necessary to consider it, and to make provision for such part of it as could not with certainty be prevented or overcome.

The condition assumed cannot in fact exist or even be approximated in practice. For full hydrostatic head to be exerted upon an entire horizontal joint, requires that there be no point of contact between the masses of rock or masonry above and below the plane or joint in which such pressure occurs. It requires, moreover, that there be no escape for the water at the lower face of the dam, but that it be absolutely confined without loss of head. Both these conditions are practically impossible even with the most unfavorable conditions and the poorest

* Van Buren, Trans. Am. Soc. C. E., Vol. 34, p. 493.

materials and workmanship. Under the worst conditions that could obtain in practice, actual contact would exist through nearly one-half the area of any horizontal joint, and if the structure were reasonably homogeneous, it would afford escapes from the lower face of the dam so abundant that though large leakage might occur, the hydrostatic head would be nearly or quite consumed in friction in its passage through or under the dam, and could not be in full force throughout the joint as assumed. We know from abundant experience that concrete can be made so nearly impervious that any leakage must be extremely slow and through such minute passages that any appreciable velocity of the percolating waters must consume a large amount of head in friction. We also know that many natural rocks, such as limestones, shales, and most crystalline rocks, are practically impervious except along seams, and that the existence of these may be discovered and largely provided for.

As far as the masonry is concerned, it is entirely possible with proper design and good workmanship to practically eliminate internal water pressures, first by excluding the water by extra care in placing the best selected materials used in the construction of the water face of the dam, and second by providing an adequate drainage system just below the water face so that any percolating waters may be intercepted and carried away harmlessly before penetrating any considerable distance into the structure. Such provisions have been made in many recent high dams and results show them to be effective.

In the Arrowrock Dam on the Boise River in Idaho, besides using a rich mixture of Portland cement mortar and placing it with special care in the water face of the dam, further tightness was secured by coating the surface of the structure with "gunnite" or the product of the cement gun, projected with great force against the face of the dam to which it firmly adheres, and forms a dense and practically impervious plaster of cement.

At a distance of 5 feet downstream from the upstream face of the dam a series of open wells were built into the masonry, at intervals of 5 feet parallel to the axis of the dam, and 5 feet

back of this row another similar row of wells was provided with the location of each well staggered with reference to the wells of the first row. This reservoir has been filled to overflow several times, and each time remained full or nearly full for several weeks. In all this time the only leakage has been through those drainage wells that coincide with the contraction joints of the dam.

Similar provisions against uplift in the masonry have been carried into effect with complete success at the Elephant Butte Dam in New Mexico, and the Narrows Dam on the Yadkin River in North Carolina. At the latter the water-proof coating was of gas tar instead of gunnite.

It is thus shown to be entirely practicable to prevent any considerable uplift in the masonry itself by rigidly providing certain simple precautions. To exclude such forces from the foundation, however, is not so easy. The precautions to be taken must depend to a large extent upon the character of the foundation, extending far below the base of the dam where detailed conditions can be only imperfectly known. In addition to these precautions these dams were built in vertical sections or columns formed by providing joints or seams passing through the dam normal to its axis, and oiling these seams to prevent adhesion of adjacent sections. Alternate sections were carried to considerable height and allowed to season before the intervening sections were built, and the latter were placed in cold weather, so that in warm weather the entire structure was placed in compression by the expansion due to temperature.

Each of the vertical joints through the dam was provided with one of the drainage wells above described, to intercept any leakage due to opening of the joint from any cause. The precaution of building alternate sections in cold weather seems to have been effective in tightly closing these joints as very little leakage has been detected.

7. Design of Gravity Dams.—From the preceding pages it appears that the gravity dam must be so designed and constructed as to have the following characters:

1. It must be free from tension, especially on the water face.

2. It must be safe against sliding on any joint or on foundation.
3. It must be safe against overturning.
4. The pressures upon any plane of the masonry or foundation must be kept within safe limits.
5. The entrance of water under pressure into the masonry or foundation should be prevented as far as possible, and where it occurs, should be relieved by drainage.

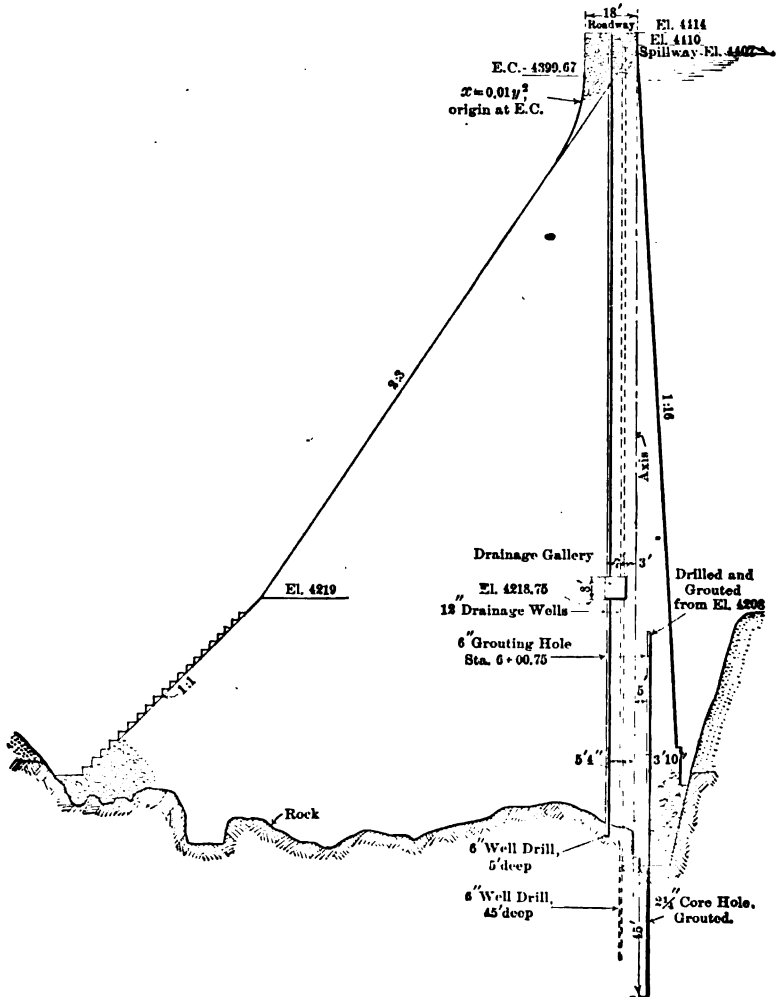

FIG. 217.—Section of Elephant Butte Dam, Rio Grande, N. M.



FIG. 218.—Elephant Butte Dam, Cableways and Mixing Plant, Rio Grande, New Mexico.

If the character of the work and the materials of construction are good, and the foundation is good rock, the first three of the above requirements are generally met by so designing the dam that the resultant line of pressure of all forces acting upon the dam will, under all conditions, fall within the middle third of the foundation or of any horizontal joint.

If practicable it is desirable to provide a spillway at such a distance from the dam as to avoid any menace to the dam or its foundations from the energy of the falling water, and avoid the necessity of passing water over the top of the dam. If the foundation is good, however, it is feasible to pass the flood waters over the top by making suitable provisions therefor in the design.

Any mobile liquid like water, when free to move, exerts a pressure at any point which is equal in all directions.

The pressure of a uniform column of water upon a unit surface is equal to the height of the column multiplied by the weight of a unit volume of water. At the surface of a lake the pressure is zero. At the depth of 10 feet the pressure upon a square inch surface is equal to the weight of a column of water of 1 inch cross-sectional area and 10 feet high. In other words, the pressure of water on a unit area of a dam increases directly as the depth, and may be resisted by a reaction increasing in like progression. It may therefore be represented by a triangle having its apex at the surface of the water and its base in the plane of the bottom of the reservoir.

Considering this triangle as made up of a series of horizontal courses of masonry, the width of base of the triangle may be found by the following formula:

$$T = \frac{dw}{W'f}$$

where T = thickness in feet of dam at a given depth;

d = depth in feet;

w = weight of a cubic foot of water in pounds;

W' = weight of a cubic foot of masonry in pounds;

f = coefficient of friction of one course of masonry upon the course below it.

Taking the weight of masonry as 2.3 that of water, and the coefficient of friction as .6, we have from the above equation, as a condition of equilibrium so far as sliding is concerned,

$$T = .725d.$$

A margin of safety against sliding may be provided by increasing the coefficient of d , and still more by bonding the dam firmly to its foundation, and building it as a monolith, so that it cannot slide without shearing the masonry of the structure, or the rock in its foundation.

Reference is made above to the advantage of building a gravity dam as a monolith, as this introduces a resistance to shear that strengthens it against sliding on a horizontal joint, and also against some other methods of failure. There are some reasons, however, for providing definite vertical joints normal to the axis of the dam, and these reasons have led to the adoption of such joints in the design of some of the large masonry dams recently built. The principal reasons for this provision are two:

Experience has shown that any mass of masonry of considerable length subjected to wide ranges of temperature is liable to crack under the influence of cold, and if built monolithic, these cracks are ragged and irregular and grains of sand and mortar are loosened to be crushed when warm weather closes the crack, and thus incipient disintegration is invited. They may admit water to the interior of the dam and introduce internal pressures at points where no provision has been made for taking care of it. These troubles may be reduced by building the dam in separate sections with definite predetermined contraction joints normal to the axis of the dam, which can open in cold weather without rupturing the masonry, and where any leakage caused can be intercepted by drains provided in advance.

Another good reason for providing such joints is the advisability of avoiding any horizontal joints. New concrete does not adhere well to that which has been seasoned for some time. When masonry work is spread over a large surface like the

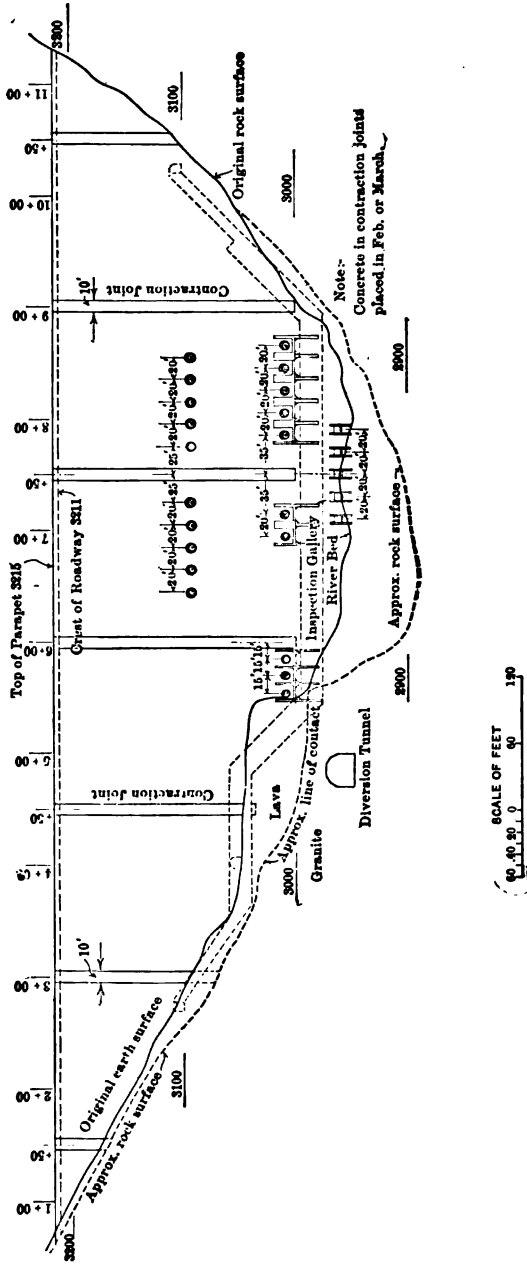

FIG. 219.—Elevation of Arrowrock Dam, Boise River, Idaho.

horizontal section of a large dam, where the surface area may reach 20,000 or 30,000 square feet, it is impossible to always place masonry on former work before it has become seasoned,—

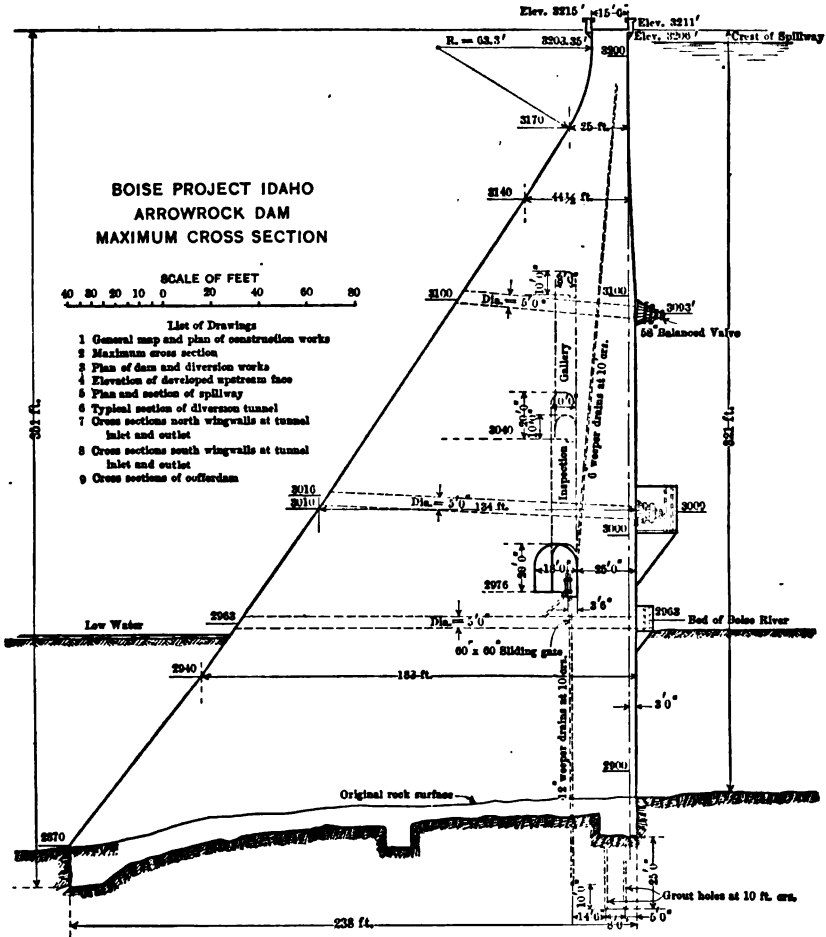

FIG. 220.—Maximum Section of Arrowrock Dam.

in fact this desirable condition is more likely to be the exception than the rule. If, however, the work be confined within forms bounding certain definite sections of limited area, this can be carried on at such a rate that new work can always be placed

on previous work not yet seasoned, and good bond thus obtained while work on that section is continued. When it becomes desirable, after several weeks or months of concentration on that section, to leave it and go to another, elaborate pains can

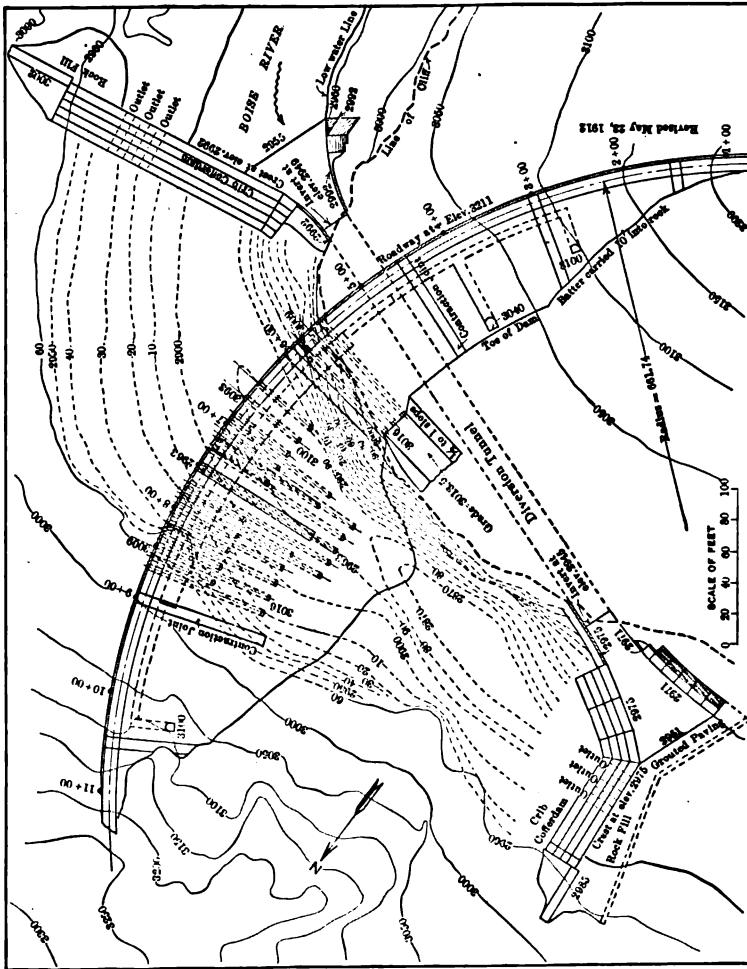

FIG. 221.—Plan of Arrowrock Dam, Boise River, Idaho.

be taken to leave the surface in such shape with projecting stones, etc., that a good bond will be obtained when work is resumed at that point. We thus secure greater immunity from horizontal joints by providing a limited number of predetermined definite vertical joints.

It is, however, important to take precautions against the liability of the contraction joints to open in cold weather. To prevent this, it is important to carry the masonry up in alternate columns, leaving a number of gaps in the dam to be filled with masonry after the adjacent columns have become seasoned. Considerable heat is generated in the chemical process that takes place in setting cement, and as this stage passes, the cooling process contracts the concrete, producing a tendency to crack. If the intermediate sections are postponed until this contraction has taken place, and also while the further contraction of cold weather is at or near its maximum, a condition is reached wherein the masonry in place is at minimum volume, and by then filling in between them in late winter and early spring, the summer temperature will place the whole mass in compression, and tend to prevent cracking. It is best to make the sections built last much smaller than their predecessors, so as to secure the greatest effect of the precaution described. The vertical joints should be designed with offsets so as to present a series of right-angled turns in the path of any leakage water passing through. The joints should be oiled to prevent adherence, and each joint should be provided with a vertical drainage well near the upstream face, to intercept any leakage and conduct it to the drainage tunnel. (See Fig. 219.) The construction of the dam in columns is illustrated by the view of Elephant Butte Dam, where this was done. (See Fig. 222.) This dam is a demonstration of the success of this measure, which has had no bad effects, and has reduced the leakage to a very small amount.

The condition that the line representing the resultant of all the forces acting upon the dam shall everywhere fall within the middle third of the cross-section of the dam, usually requires a thickness from two-thirds to three-fourths of the depth of water to be sustained, depending upon the weight of the masonry. This gives a factor of safety of two or more against failure by overturning by revolving about the lower toe as a fulcrum. As the lower toe is an undulating line, rising toward both ends of the dam, it cannot constitute such a fulcrum,

and no part of the dam can overturn without shearing the masonry in one or more planes, which gives a large added coefficient of safety in this respect.

Pure theory of resistance of water pressure requires that the dam have a thickness of zero at the highest water level. To prevent overflow from wave action or abnormal rise of the water and as a margin of safety it is necessary to carry the



FIG. 222.—Elephant Butte Dam, showing Construction in Alternate Columns.

masonry somewhat higher, and practical considerations demand an appreciable thickness at the top. It is usually desirable to use the top of the dam as a roadway and for this and other practical reasons to give it a thickness of from 10 to 16 feet, depending upon the circumstances. The water face is usually made vertical or nearly so, and the lower face may also be vertical down to the plane where the thickness must increase in order to meet the requirement that the resultant of forces fall within the middle third. This is secured in the average

case by sloping the downstream face on a slope of about 3 horizontal to 4 vertical, varying, however, with the weight of the masonry. These slopes may continue downward from the top to the point where the pressure on foundation at the lower toe, reservoir full, and on the heel, reservoir empty, reaches the safe limit of pressure either upon masonry or upon foundation.

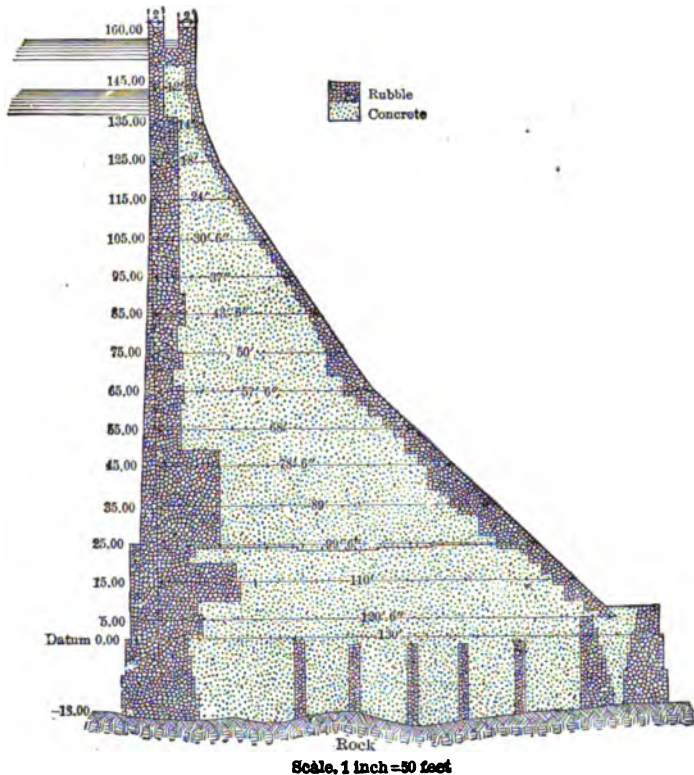

FIG. 223.—Cross-section of Periar Dam, India.

At this point the slope of the lower face must be increased to about 1 on 1, to prevent increase of unit pressures, reservoir full. To prevent increase of pressure on the heel a slope of the upper face must be adopted, which will increase the bearing surface as fast or faster than the vertical pressure.

It is sufficient, as a rough rule, to begin the batter just above

the point where the limit of pressure is reached, and carry it down on a ratio of 1 horizontal to 10 vertical.

It is reasonable and logical to assume a higher limit of safe pressure at the heel of the dam than at the toe, because the former limits can be reached only when the reservoir is entirely empty, which will seldom occur in practice, and a failure at that time will affect only the structure itself, without menace to human life or to other property than the dam.

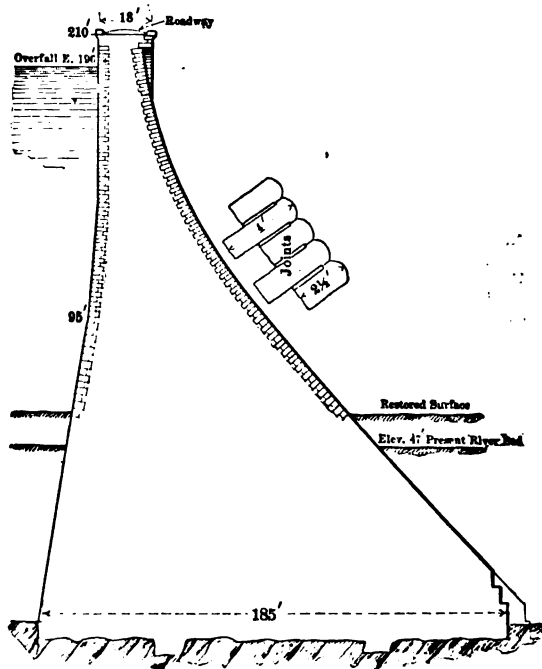

FIG. 224.—Cross-section of Masonry Dam, New Croton Dam, Cornell's.

On the other hand the pressures on the toe reach their maximum only when the reservoir is full, which is supposed to happen frequently, and failure under such circumstances would entail awful havoc, devastation, and loss of life. Such possibilities always demand much higher factors of safety than cases where such vast risks of life and property are not involved.

The primary reason for the requirement that the resultant of

forces always fall within the middle third is the desirability of avoiding any tensile stresses in the masonry. This is far more important on the water face of the dam than on the downstream face. If the resultant of forces, reservoir full, falls without the middle third, it tends to produce tension on the water face. This is extremely undesirable, as it tends to open cracks in the masonry at times when water under pressure is ready to enter such cracks and exert a pressure tending both to overturn the dam and to cause sliding, at the time when failure would be most disastrous. At the same time the requirement in question gives us a margin of safety against overturning.

The avoidance of tension on the water face of the dam or foundation is so important that the resultant of pressure, reservoir full, should be kept sufficiently inside the middle third to amply cover any errors that can occur in the assumed weight of masonry, force of wind and waves, ice thrust, or extreme height of water in the reservoir.

Should the resultant fall outside the middle third, reservoir empty, it will tend to produce tension on the downstream slope of the dam, which is theoretically undesirable, but not nearly so important as if it occurred on the other side, first, because there is no water to enter the masonry on the downstream slope, and second, because it occurs with reservoir empty, when there is no real danger of failure, and no life or property menaced thereby. On the other hand the tension that theoretically begins as the resultant passes from the middle to the outer third, is based on the assumption that the masonry is rigid and inelastic. Any elastic yield will tend to modify the theory, and slightly shift the point at which the tension begins. Moreover, well-built masonry will stand some tension and good practice sometimes allows a tensile stress in concrete of 50 pounds per square inch. Standard specifications require a strength of 150 pounds per square inch at thirty days, for Portland cement mortar, and good cement will greatly increase this with further age.

Any tendency of the resultant to fall outside of the middle third on the water side, reservoir empty, is necessarily accompanied by greater vertical pressure at and near the water face,

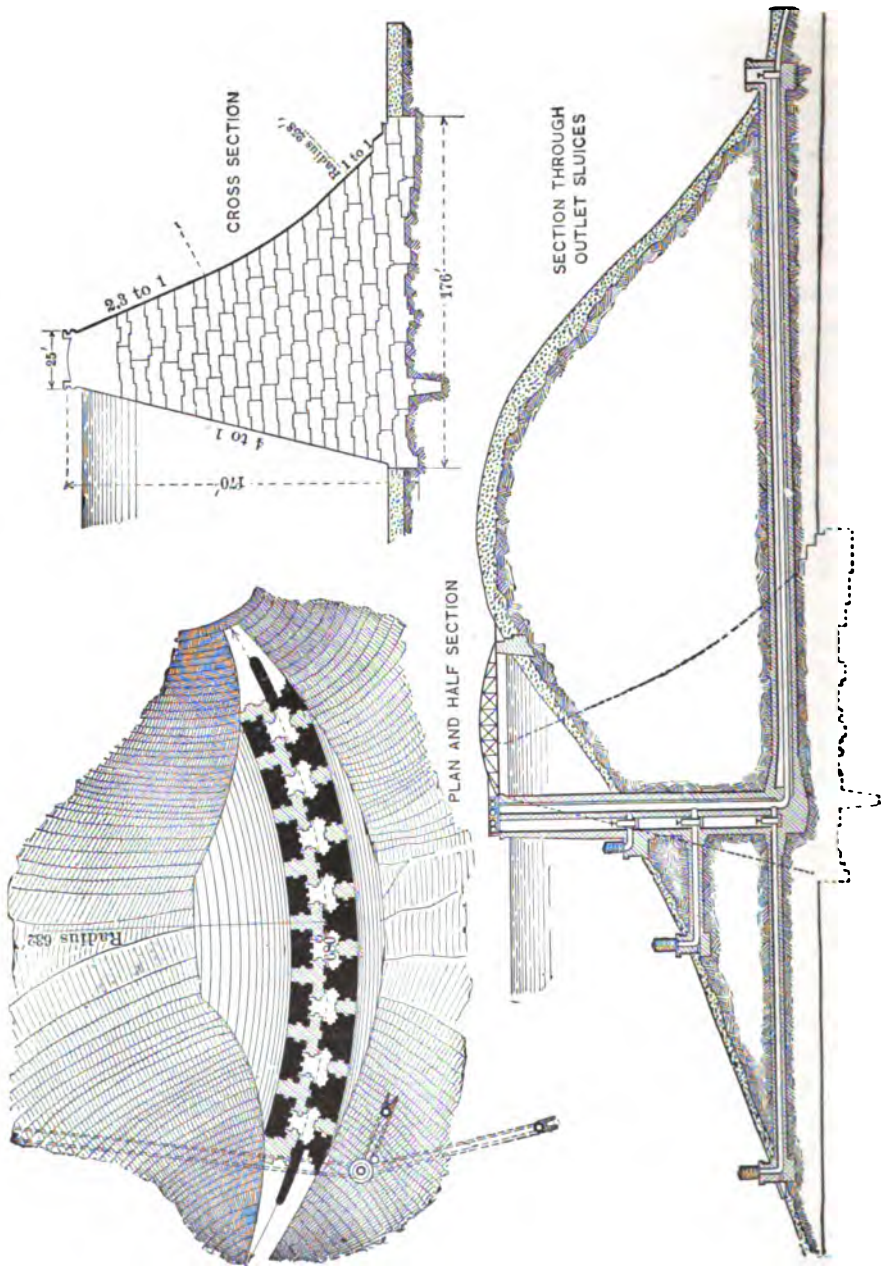

FIG. 225.—Plan, Cross-section, and Outlet Sluices, San Mateo Dam, California.

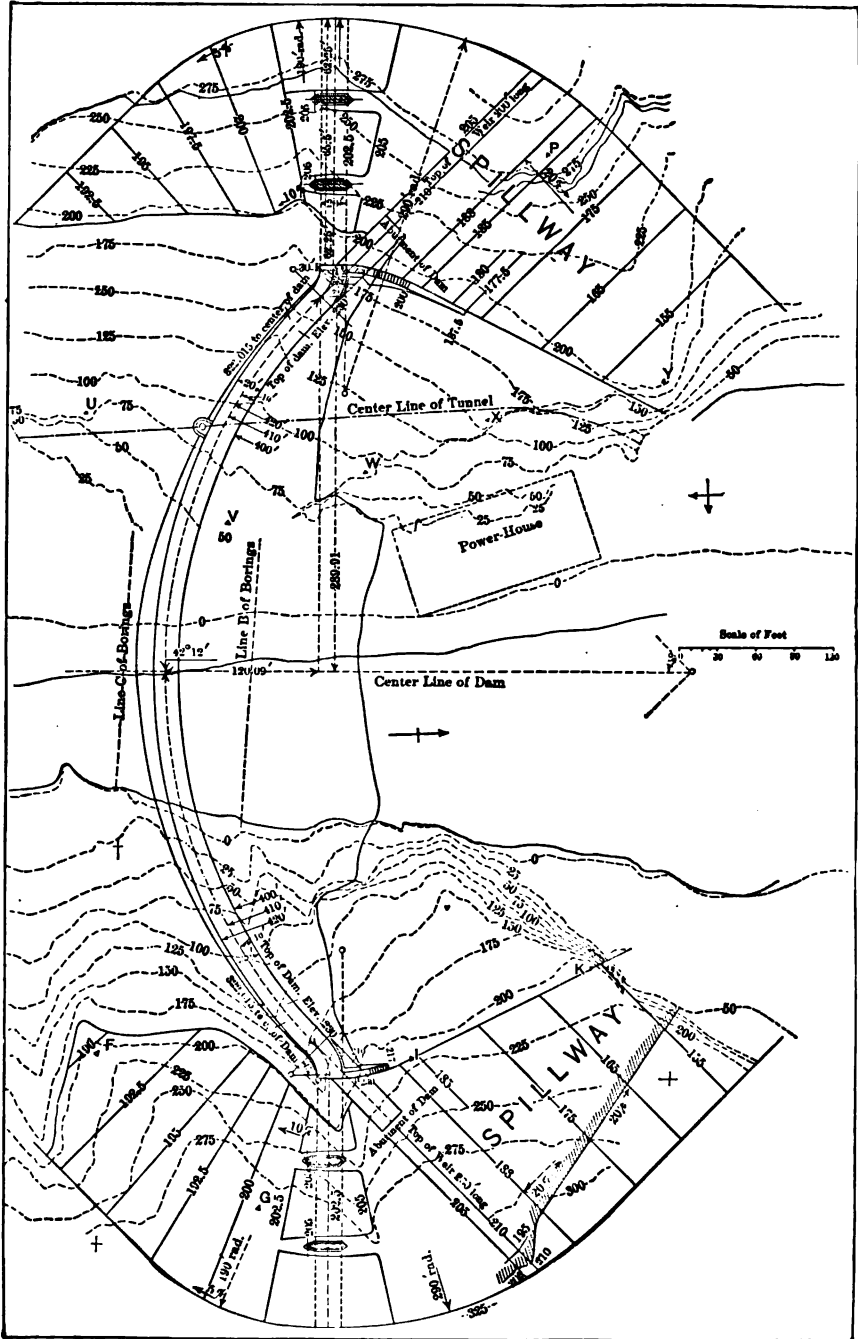

FIG. 226.—Plan of Roosevelt Dam, Arizona.

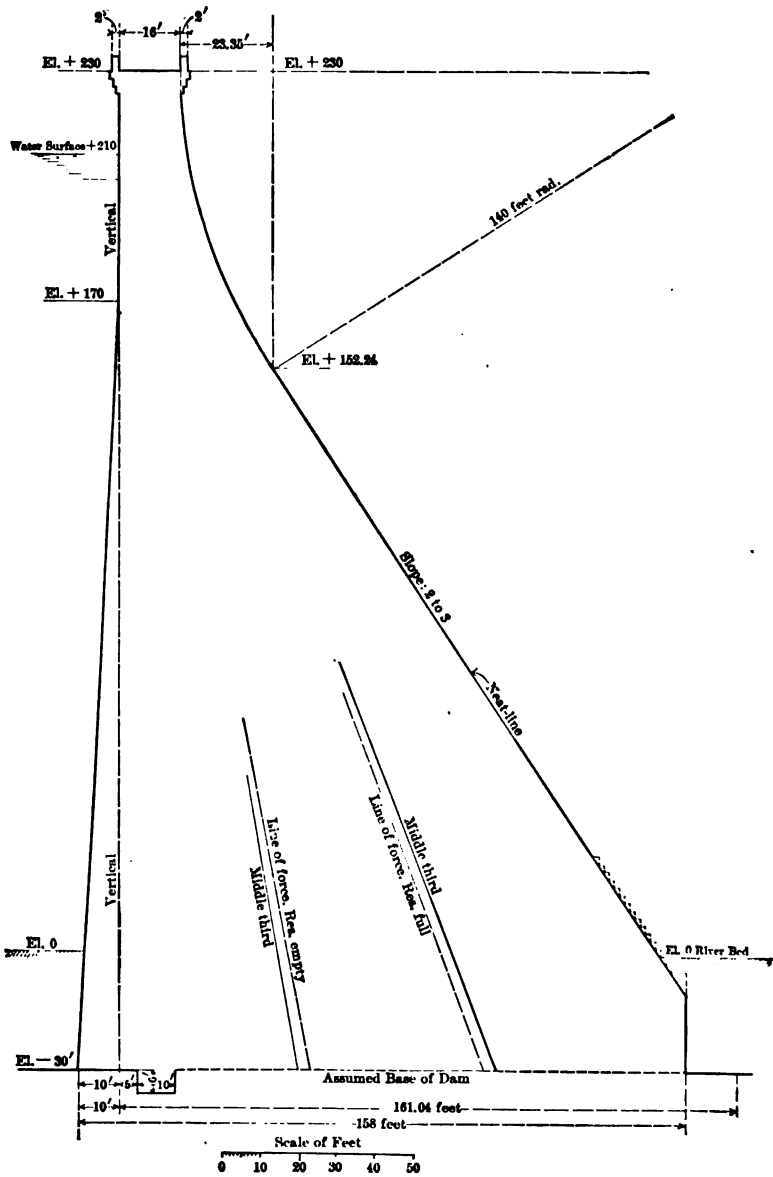

FIG. 227.—Maximum Cross-section, Roosevelt Dam, Arizona.

and this tends at all stages of the reservoir to close and keep closed possible horizontal openings, and thus to exclude water from the masonry. There is, of course, no danger of the dam overturning toward the reservoir when it is empty.

It is thus seen that there is no valid objection to allowing the resultant of pressure, reservoir empty, to fall slightly outside the middle third, so long as the actual pressures on masonry are kept within safe limits.

8. Design of Arch Dams.—As pointed out on page 449 any masonry dam can be made more secure against sliding and overturning than it would otherwise be by building it on a curved plan, convex upstream. This makes it impossible for the dam to yield to the water pressure, without crushing the masonry or abutments, thus utilizing forces not brought into play by its resistance simply as a gravity structure.

Navier's formula for computing water stresses on the voisoirs of an arch is as follows:

$$Q = PR,$$

Where Q = the compressive stress upon any strip of unit width extending through the dam, at any given depth;

P = horizontal pressure on unit surface at the same depth;

R = radius of the curve of the extrados of the arch.

This value is based entirely on the assumption that all the pressure is sustained by the arch. It shows that the pressure is inversely as the length of the radius, and therefore the longer the radius the greater the pressure, and the thicker must be the dam section.

As we shorten the radius we reduce the stresses and thus permit reduction of the thickness of the dam, but at the same time we have increased its length. Jorgenson has shown that the gain exceeds the loss in a decreasing amount until we have a radius equal to less than five-ninths of the width of the canyon at the dam site, shortly after which the balance gradually shifts the other way. This gives an arc of a little over 133 degrees. The theoretical advantage in using so long an arc, or in other



FIG. 228.—Pathfinder Dam, North Platte River, Wyoming. Lower face showing concrete ladder, and 6500 second-feet of water discharging from tunnel.

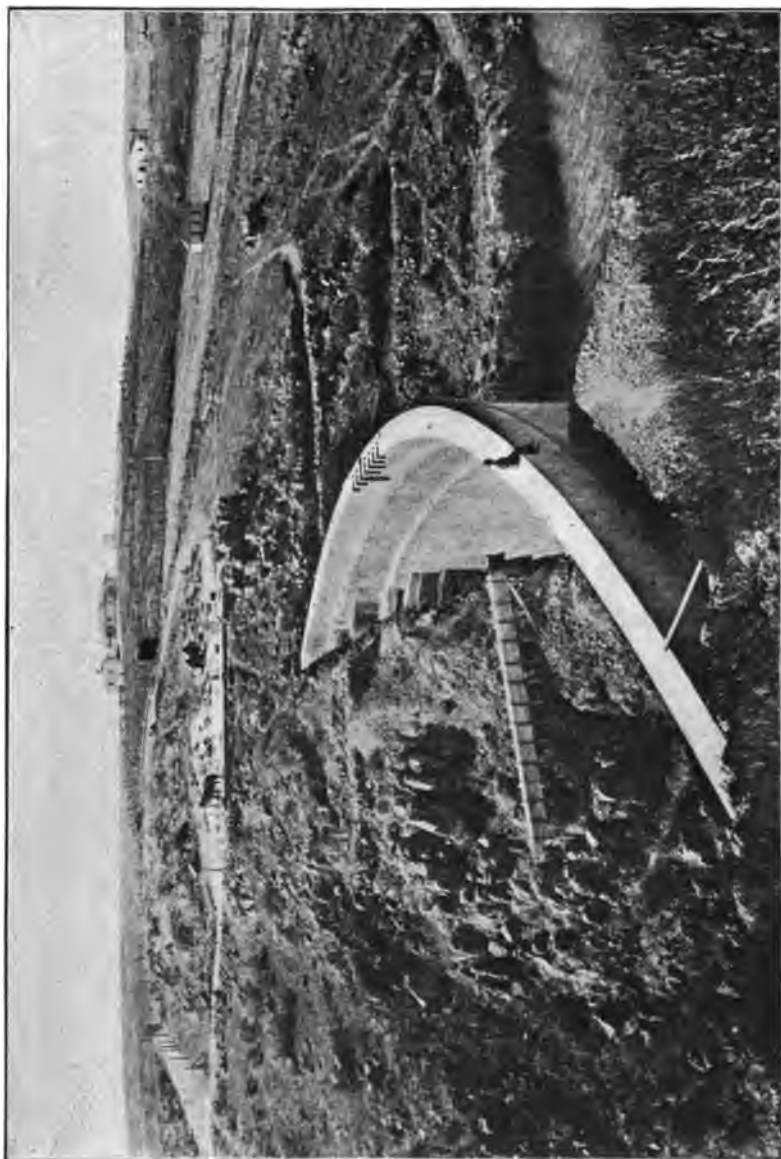

FIG. 229.—Upper Otay Masonry Dam, California.

words, so short a radius over that of a somewhat longer radius is small, as the diminished thickness of the dam tends to diminish its resistance as a cantilever, and increase its susceptibility to vibration. In practice, therefore, it is desirable to make the included angle about 120 degrees if the physical conformation of the dam site is suitable.

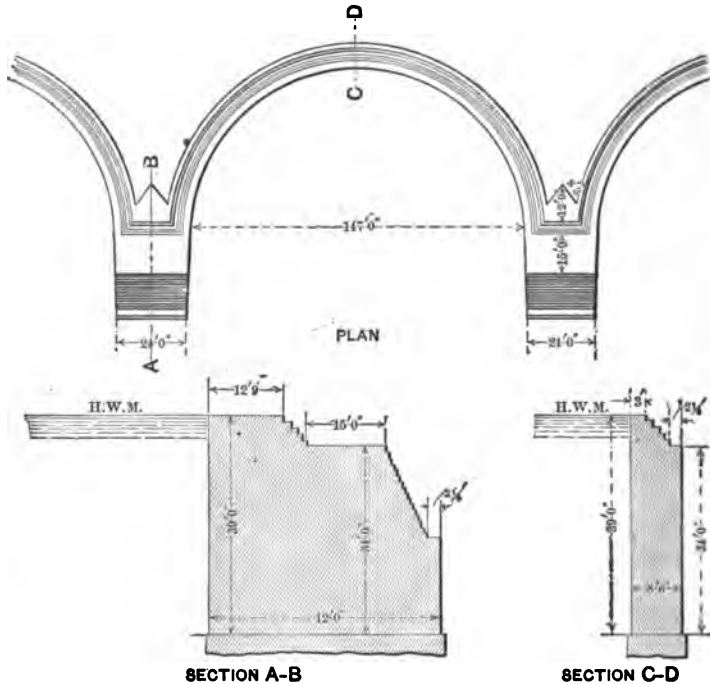

FIG. 230.—Meer Allum Dam, India. Plan and Section of One Arch.

All dam sites are wider at top than at bottom, and most of them have a shape somewhat resembling the letter V. It follows, therefore, that to obtain the greatest practical benefit from the arch action it becomes necessary to vary the radius from a very short one near the bottom, to a longer one at the top.

This design of dam has been called the "variable radius" dam, or more often the "constant angle" dam, and has been patented by F. G. Baum & Company, of San Francisco, California. The Salmon River Dam near Juneau, Alaska, has been

built on this principle, and to a less degree of exactness, the Lake Spaulding Dam on the South Yuba River in California.

The most convenient and clearest expression is to state the curvature in terms of the radius, and this in terms of the width of the canyon, or in other words the chord of the angle.

A rough rule for the change of curvature in an arch dam which secures the benefit of the variable principle and gives due weight to practical considerations, is to begin at the bottom with a radius of about three-quarters of the chord at that level, and change this radius gradually and uniformly toward the top, ending at the top with a radius nearly five-ninths the length of the chord at that level. This will vary the subtended angle from about 84 degrees at the bottom to about 120 degrees at the top. It will secure the benefit of cantilever action near the bottom where most important and

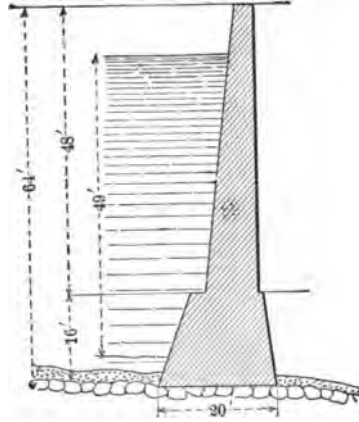

FIG. 231.—Cross-section of Bear Valley Dam, California.

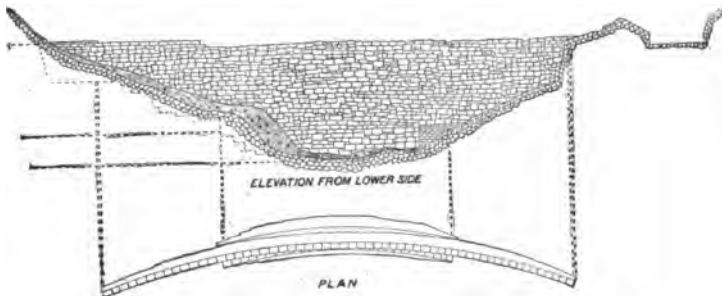

FIG. 232.—Plan and Elevation of Bear Valley Dam, California.

avoid most of the practical difficulties of construction involved in a too rigid adherence to a constant angle.

In many cases a dam site widens rapidly near the top, and becomes too wide to be closed by a dam acting as an arch,

while the lower part of the site is well adapted to such an arch design. In such a case, it is often possible to build masonry abutments as gravity structures of moderate height, and thus

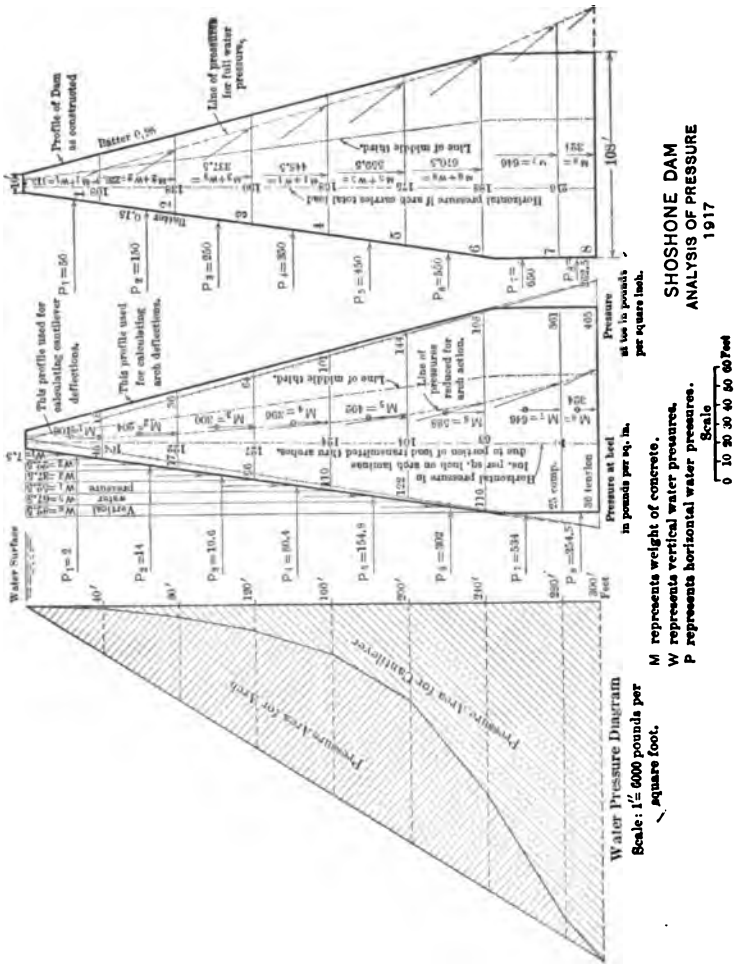

FIG. 233.—Shoshone Dam, Wyoming. Analysis of Pressures.

make a necessary span for the arch, of 400 or 500 feet, well-adapted to closure by an arch. The artificial abutments become simply tangential continuations of the arch. They are straight gravity dams, and receive endwise the thrust of the arch.

9. Masonry Overfall Dams.—Where it is intended that water shall flow over the top of a dam the prevailing practice is to give the top and lower slope a compound curve, such that the water in flowing over will everywhere rest upon masonry and not leave a vacuum behind the sheet of falling water, and so that the water will be guided into a horizontal direction as it leaves the dam.

Where water falls, as in flowing over a dam a quantity of energy is generated, equal to the weight of the falling water

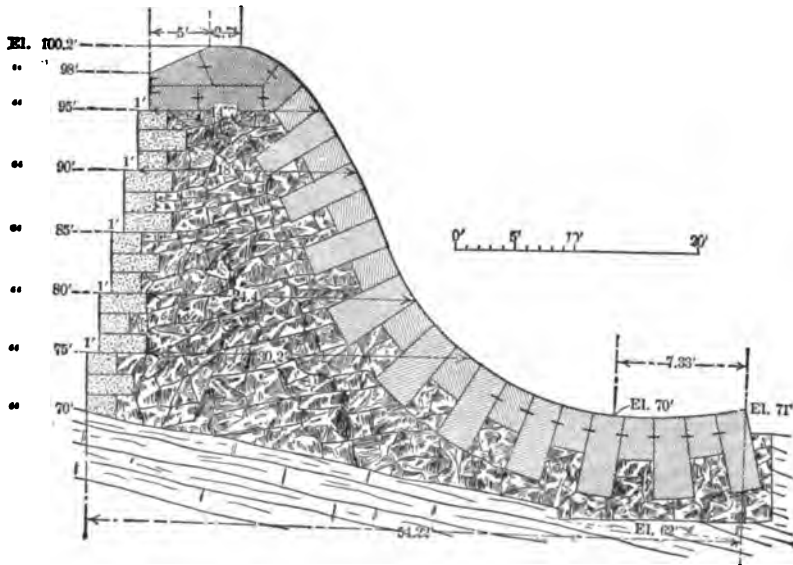

FIG. 234.—Cross-section of New Holyoke Weir, Mass.

multiplied by the height of the fall. This energy must somehow be dissipated in friction either in its own mass, or upon its channel. Different engineers hold different theories concerning the best method for preventing this energy from destroying or injuring the dam. One method is to dissipate the energy as soon as possible at the time and place of its generation. To this end the water is made to fall as nearly vertically as possible upon steps or shelves of masonry on the lower side of the dam, and finally into a pool or water cushion at the toe of the dam,

where the desired end is accomplished by impact and friction upon the masonry and upon the bottom and sides of the pool, and by the lashing and churning of the water in its own mass. It is caused to emerge quietly from the pool at moderate velocities that will not erode the channel below. This method, of course, requires the best of massive construction to prevent damage at the points of impact and erosion, and it is usually

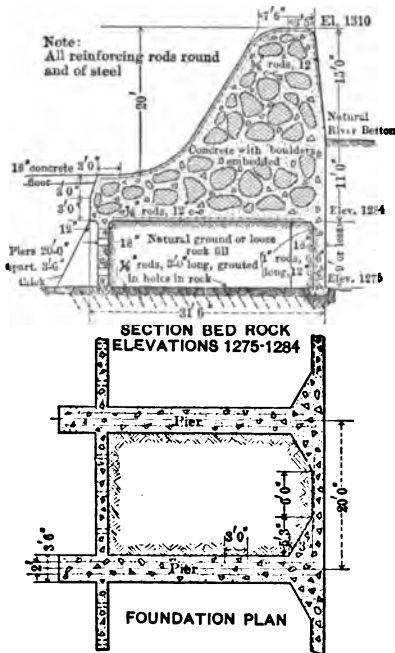

FIG. 235.—Cross-section of Granite Reefs Weir, Salt River, Arizona.

necessary to protect the river banks for some distance below, from erosion by the waves of the agitated water as it leaves the vicinity of the dam.

The other method is to guide the water down the lower slope of the dam and gently deflect it to a horizontal direction, disturbing its velocity as little as possible, and leading it as far as possible from the dam before much of its energy is dissipated. The object is to cause the water to expend its stored energy in overcoming the friction of the river bed at some distance from the dam, instead of on the dam itself. This

method also requires protection of the river banks from erosion for a considerable distance below, unless they are naturally composed of good rock.

Where this method is adopted, the water falling over the dam arrives at the toe with a very high velocity, which is that of a body falling through the same height under the action of gravity, minus the friction losses upon the dam and the air. If the vertical motion is changed by the curves of the masonry, very

gently, to a horizontal direction, it will retain nearly the same velocity and flow away from the dam at that rate for a short distance, and suddenly, and with great commotion check its velocity, and increase its depth in proportion. This is called the "hydraulic jump." Where this change, and the corresponding commotion occurs, a great deal of work is done by the water upon its own mass and upon its channel, the work being sufficient to absorb the difference in energy between the velocity above and below the hydraulic jump. If the channel at this point is too soft or friable to resist this violent action, it must be well protected, or measures must be adopted to check the velocity and dissipate the energy nearer the dam. This latter alternative

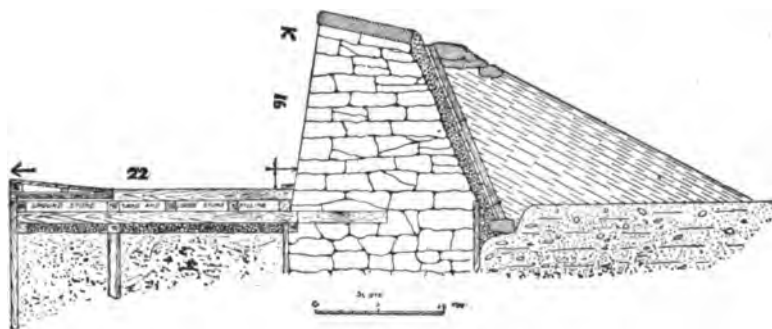

FIG. 236.—Cross-section of Norwich Water Power Company's Weir.

was adopted at the spillway of the Gatun Dam on the Canal Zone, and at the Bassano overflow dam in Alberta, Canada.

At Gatun, two rows of staggered rectangular baffle piers of concrete were placed near the toe of the dam to intercept the swift water, deflect parts of the stream upon other parts, and thus destroy the major portion of the energy stored in the swift water. The object was attained, but the impact of the water upon the baffle piers was so destructive that it was necessary to protect them with heavy cast-iron plates to receive the shock. This provision has accomplished the purpose.

The Bassano Dam is equipped with two staggered rows of "baffle piers," shaped like snowplows pointed upstream, and designed to split up the high-velocity sheet of water before it

can strike the bed of the stream, and throw one jet against

another so that the energy will be absorbed as much as possible by eddies within the body of the downstream pool, and not by tearing the foundations. The baffle piers are not designed to destroy the energy by impact, but to start eddies in the water, and insure the start of the hydraulic jump at the toe of the dam, so that its stored energy will be dissipated before it leaves the concrete apron.

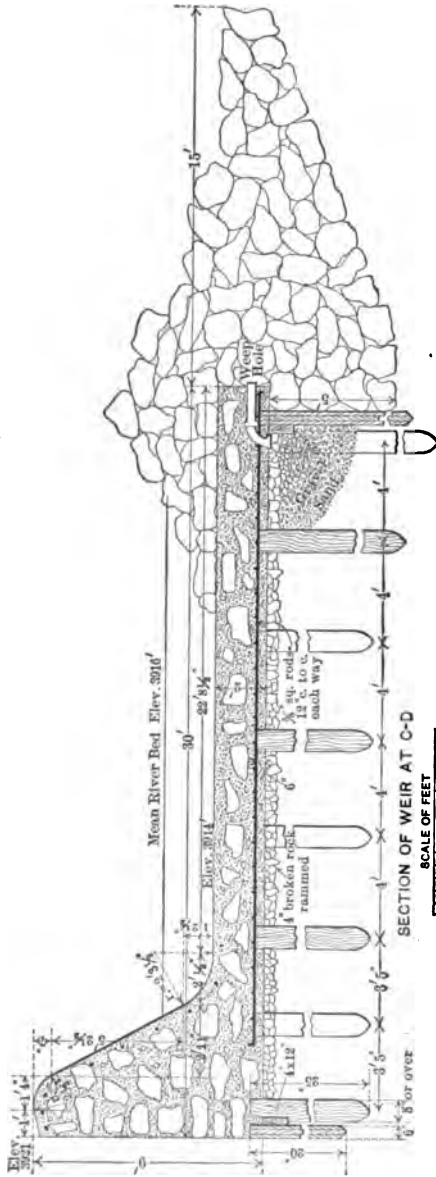

FIG. 237.—Leasburg Diversion Weir, Rio Grande Project, N. M.

10. **Hollow Concrete Dams.**—An introduction of comparatively recent years, is a variety of hollow or cellular dams, built of reinforced concrete. These are developments of the timber dams built with rather flat water slopes, so as to introduce a vertical

component of water pressure, tending to give weight to the dam and hold it in place. The corresponding concrete

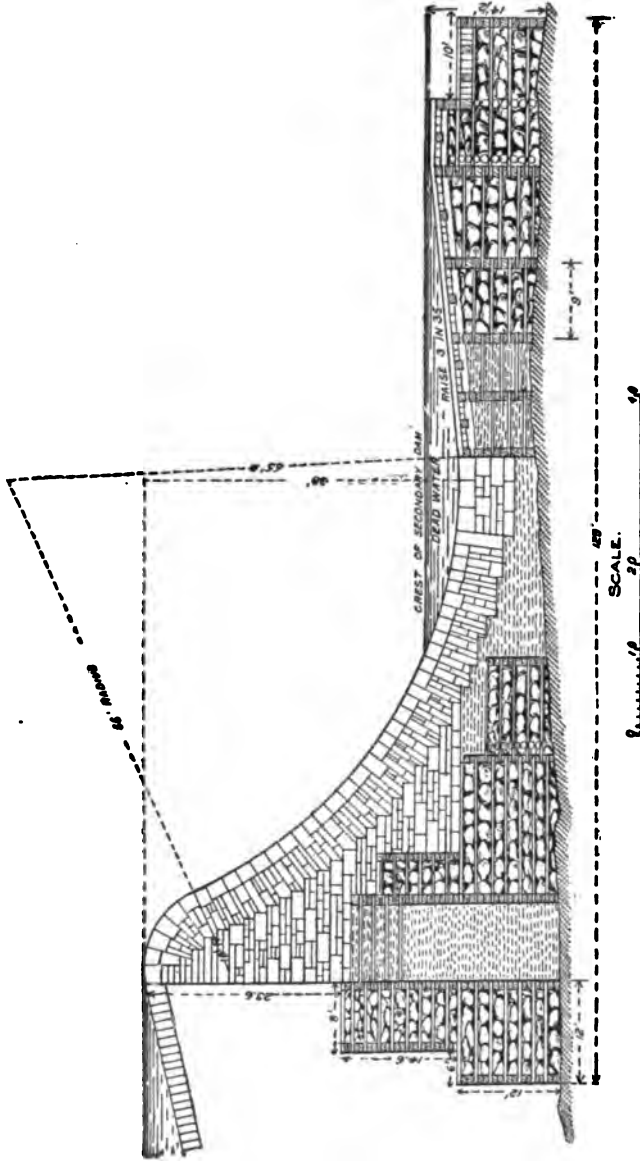

FIG. 238.—Cross-section of Old Croton Dam, New York.

type consists of a series of buttresses, supporting a sloping deck composed of reinforced concrete slabs. A modification of this

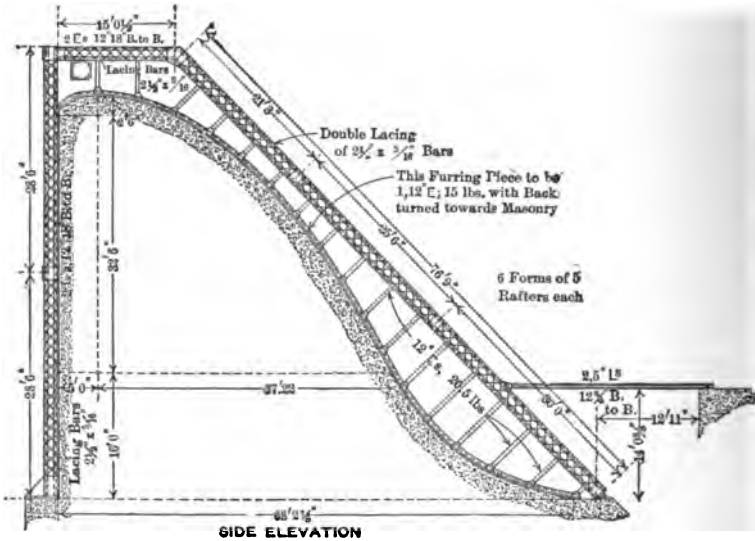

FIG. 239.—Steel Forms. McCall's Ferry Dam, Susquehanna River, Penn.

type employs arches of plain concrete instead of reinforced slabs to close the gaps between buttresses. This is called the multiple arch type of dam. In favor of this type is the fact that

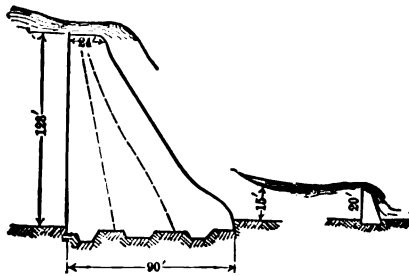

FIG. 240.—Cross-section of La Grange Dam, California.

it does not require reinforcement, which in time might corrode, but this is met by the argument that in the case of the multiple arch dam, the failure of one arch would remove the support



FIG. 241.—Granite Reef Dam, Salt River in Flood, showing Hydraulic Jump.



FIG. 242.—East Park Reservoir Spillway, Orland Project.



FIG. 243.—Diversion Dam, East Park Feed Canal, Orland Project.

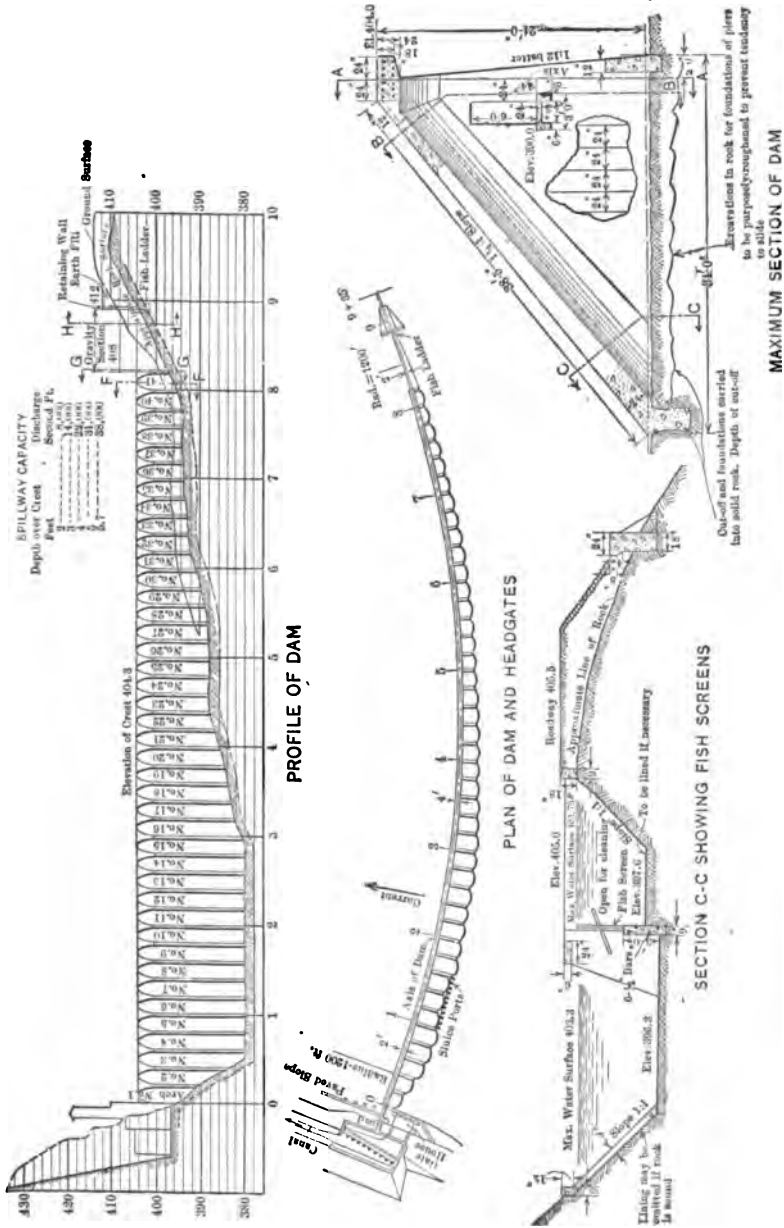

FIG. 244.—Elevation, Plan and Section, Three Miles Falls Dam, Umatilla River, Oregon.

from its buttresses, and cause them to fail under the lateral thrust of the adjacent arches, thus causing the failure of all the arches in succession. This objection to the multiple arch type can be overcome in various ways.

The most obvious way, and the one usually relied upon, is to build each arch so conservatively that it will not fail, and the side thrusts will balance. Another method is to eliminate the side thrust. If each arch is made nearly a half circle, the buttresses can be each made to take the thrust of either arch independent of any support from the adjacent arch. A third method is to tie adjacent buttresses together at the springing of the arches, with beams to take either compression or tension, thus making each buttress sustain its neighbor.

Jorgensen has shown that the angle of arch requiring the least quantity of concrete is $133\frac{1}{2}$ degrees, but that one having a longer radius, and subtending only 120 degrees, contains for the same stresses only 1 per cent more concrete, but gives 6 per cent greater thickness. As this requires less forming, and less labor in placing, it is somewhat cheaper, besides offering greater resistance to percolation of water, and is therefore preferable.

Similarly very short spans, with small buttresses close together, require theoretically less concrete than longer ones, but thin buttresses and arches, especially if high, are more likely to collapse, require more forming and labor in placing, and the arches are more likely to permit the passage of water. These practical reasons indicate spans of 40 to 50 feet, depending upon the height. With buttresses 40 feet from center to center, a radius for the upstream face of 23.1 feet will give an arc of about 120 degrees, and make economical construction.

Cellular concrete dams of either type, if low, require much less cement than the ordinary gravity type. This advantage grows less as the height increases up to heights of about 120 feet, above which, owing to increased thickness of buttresses and arch rings and necessary bracing the advantage soon disappears. The cost of steel reinforcement if used, and of forms, tends to counter balance any advantage in cement, and each

case must be carefully considered in the light of local conditions.

A unique buttressed dam of reinforced concrete has been built by the Reclamation Service to close East Park reservoir, Orland project, California. This dam, which acts as a spillway in flood, is but 11 feet high and consists of a number of circular

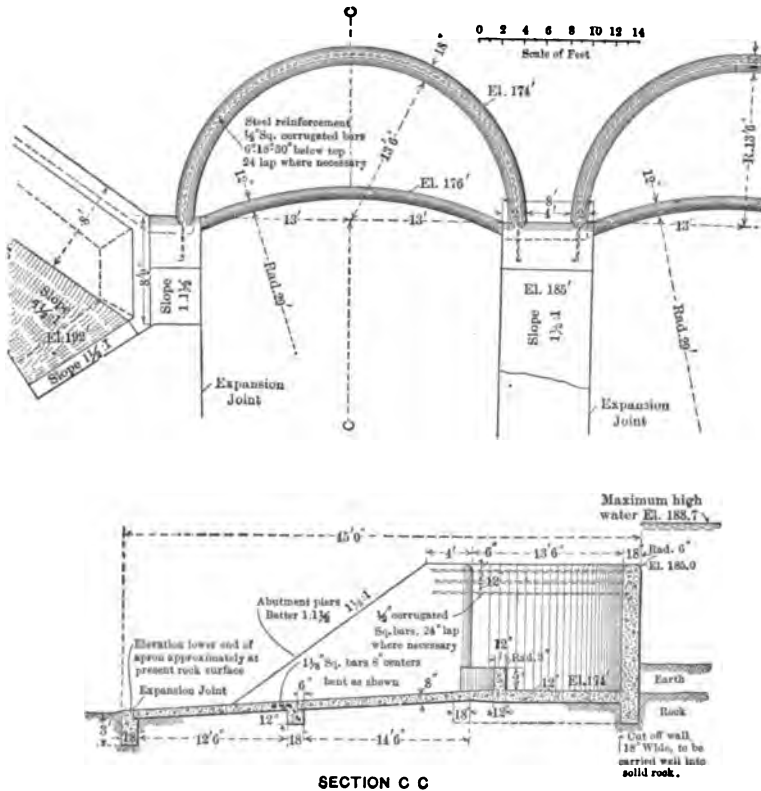

FIG. 245.—East Park Multiple Arch Spillway, Orland Project, California.

walls of $13\frac{1}{2}$ feet radius, convex upstream and sustained by concrete buttresses of 8 feet thickness, sloping downstream with gradient of $1\frac{1}{3}$ to 1.

These walls (Fig. 245) are of reinforced concrete 18 inches thick, resting on a floor 12 inches thick, and below the walls and between the buttresses are subsidiary walls 2 feet high forming

water-cushions. Downstream is a concrete apron 8 inches thick extending for a distance of 30 feet.

An important advantage of any hollow type of dam is the fact that the pressures on foundation can be limited to a small

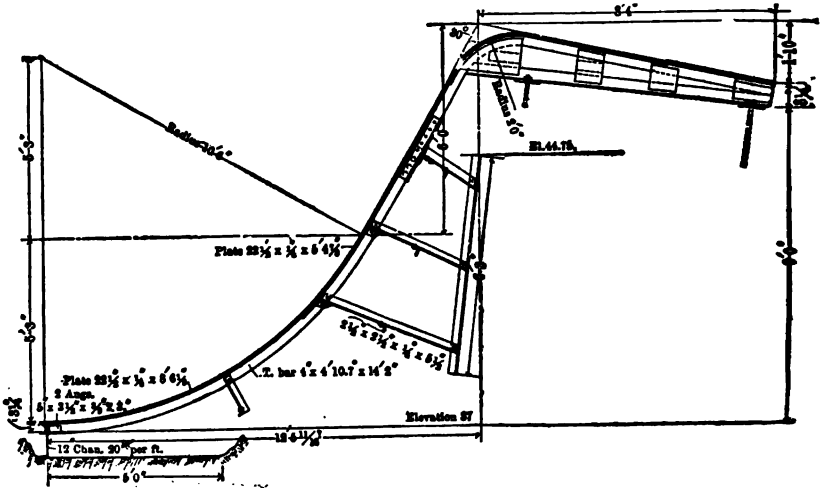

FIG. 246.—Cross-section of Iron Weir, Cohoes, N. Y.

amount by spreading the base of the dam as desired and distributing the pressure nearly equally over it. For this reason foundations of soft rock, clay, or shale can be utilized with a much higher factor of safety than possible with a gravity dam.

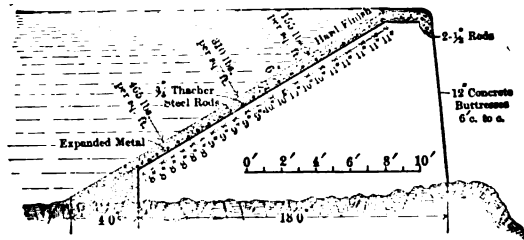

FIG. 247.—Cross-section of Reinforced Concrete Weir, Theresa, N. Y.

This possibility seems to have led to the careless preparation of foundations in some cases, and two failures of such dams have occurred, due to erosion of foundations by water under

pressure, in regard to which the hollow dam has no advantage over the gravity type. Percolation under the dam must be prevented by a cut-off wall carried down to rock and also by grouting the seams of the rock if there is any probability of erosion by percolating waters under pressure. In short, the foundation should be prepared for a hollow dam very much as for a solid dam.

11. Steel Dams.—Hollow or cellular dams, built first of wood, and later of concrete, may also be constructed of steel, and several dams of this type have been actually built. A sloping water-face is supported by a steel frame of standard shapes taking the water pressure mainly in compression. The water-face is a deck of steel plates, which, instead of being in the form of arches as in the multiple arch dam, or of beams as in the Ambursen type, are placed in the form of half-cylinders, concave upward toward the reservoir, so that the pressure of the water places the plates in tension.

Such dams are comparatively cheap, and if properly protected from corrosion should have long life.

A steel dam on the Missouri River failed, and was replaced by a masonry structure, but the failure was of the foundation and not due to the type of dam employed.

a. Steel Dam, Ash Fork, Arizona.—This structure, built wholly of metal and intended for the impounding of water, was built by the Santa Fé railway to store water for use of locomotives and for city supply, and has a capacity of 110 acre-feet.

The Ash Fork dam is 184 feet long on top, and about 300 feet in total length, including a short concrete abutment at each end. Its greatest height is 46 feet. Structurally it consists of a series of triangular steel bents or frames, resting on concrete foundations and carrying steel face-plates on the inclined or upstream face of the bents. The foundations of the steel bents are of Portland-cement concrete and the vertical posts rest on concrete walls (Fig. 248).

There are 24 bents, each a right-angled triangle, with the inclined side having a slope of 45 degrees, facing upstream, the rocky bottom of the canyon forming the base. The dimensions

of the bents vary with their height. The end bents (Nos. 1 to 7 and No. 24) are 12 to 21 feet in height, each consisting of a vertical Z-bar column and an inclined I-beam. Bents Nos. 8, 9, 22, and 23, are about 33 feet high. Each has a vertical Z-bar column, an inclined I-beam, and two inclined posts or columns built up of Z-bars, the upper of these resting on the same shoe or bed-plate as the vertical post. Bents Nos. 10, 11, 12, 19, 20, and 21 are 33 feet to 41 feet 10 inches high. These have but one inclined post, which rests on the same bed-plate as the vertical post while above it are truss members connecting the face

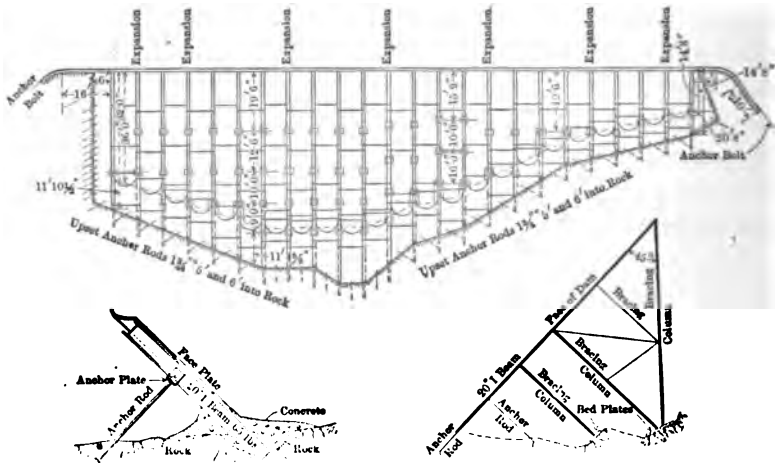

FIG. 248.—Steel Dam, Ash Fork, Arizona.

member with the posts. Bents Nos. 13 to 18, inclusive, are 36 feet to 41 feet 10 inches high, and have two inclined posts, with truss members above the upper post. In all of them the face is composed of a 20-inch 65-pound I-beam, reinforced on the underside by a plate $\frac{1}{2}$ inch thick and 18 inches wide. The vertical and inclined posts are all composed of four Z-bars and a web-plate. The bents are connected by four sets of transverse diagonal bracing between the vertical and inclined posts. The bracing is composed of single or double angle-irons, $\frac{3}{8} \times 3 \times 3$ inches, the ends of which are riveted to connection-plates.

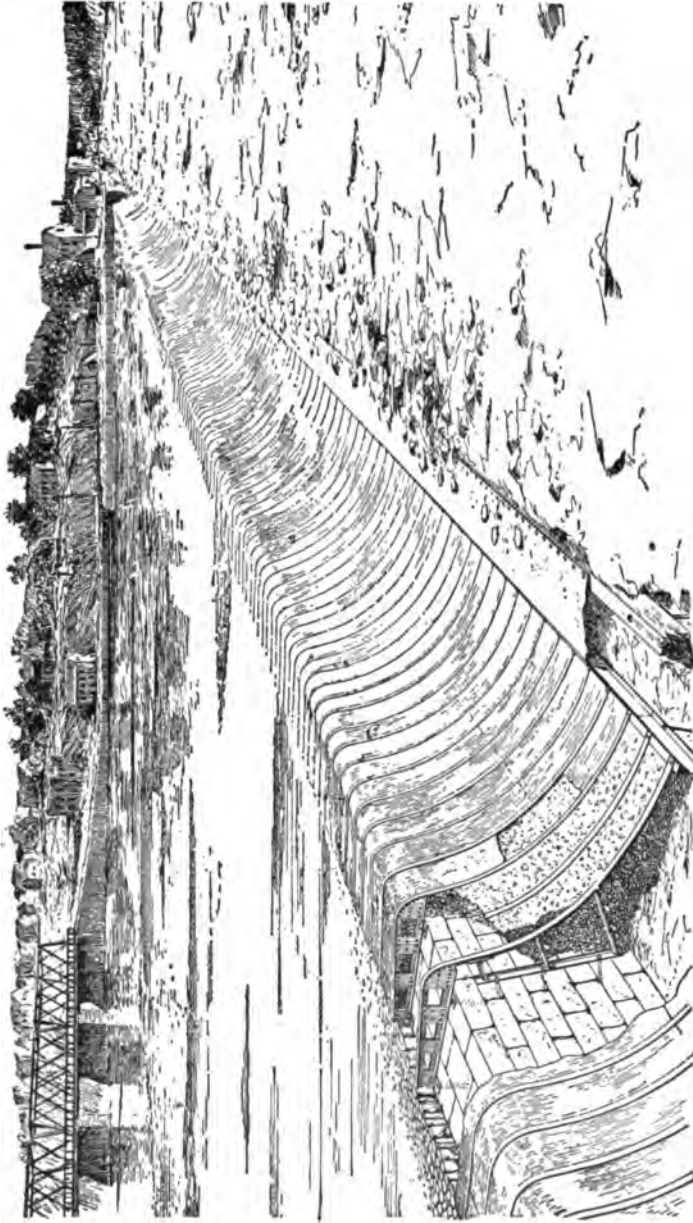

FIG. 249.—Iron-faced Rollerway Weir, Cohoes, N. Y.

The structure is composed of alternate rigid and loose panels. The crest or apron-plates which fit the braced panels between the bents are riveted to a curved angle, which is riveted to the upper end of the curved-plate, while in the unbraced panels this curved angle merely bears on the apron-plate. The face of the dam is composed of steel plates $\frac{3}{8}$ inch thick and 8 feet $10\frac{1}{8}$ inches wide and 8 feet long, riveted to the outer flanges of the I-beams of the bents. They are curved transversely to a radius of 7 feet 6 inches, forming a series of gullies or channels down the face, the widths of the channels being 7 feet 5 inches measured on the chord, leaving at each side a flat portion which rests on and is riveted to the I-beams. There are seven expansion rivets at intervals of about five bents, and all joints exposed to water-pressure are well caulked.

A weakness of the structure is that the masonry foundations were not carried down to impervious rock, and in consequence the dam at first failed to serve its purpose, much of the water impounded being passed under and around it by seepage through the permeable loose rock and volcanic cinder foundation material. Later concrete was used to connect the steel facing with the rock foundations, and this was covered with asphaltum and is reported to have greatly reduced the leakage.

12. Foundations of Masonry Dams.—The foundation of a masonry dam, especially a high dam, is an element of first importance. The structure should, if possible, rest upon rock, which must be of such hardness and strength as to resist the pressures to be applied. For dams not exceeding 50 feet in height, foundation of clay or gravel may be made to answer with proper cut-off provisions. If of clay, sand, or fine gravel, or any material into which piling can be driven, the weight should be carried on piles, providing a liberal coefficient of safety.

The foundation must in any case be practically impervious, so as to allow no water to flow through under such pressure as to cause erosion, and so undermine the dam. The exclusion from the foundation of water under pressure is important, also, for another reason. If water can enter the foundation

from the reservoir, and has not free exit, it produces a hydrostatic pressure under the dam tending to lift or float it, and unless large provision is made for this in the design, it may cause failure. We have already seen the importance of preventing tension in the masonry of the upstream face of the dam because of its tendency to admit water under pressure into the masonry, and thus produce uplift.

The method of failure of masonry dams most common is by sliding on foundation. This has occurred in at least two notorious cases in America, accompanied by loss of life and property. These were both undoubtedly caused by uplift of water in the foundations.

In each case the dam was founded on horizontally stratified rock, the bedding seams of which were filled with clay or other soft material with little cohesion, and serving as a lubricant when wet. Such foundation also affords maximum facilities for the entrance of water under the dam and the exercise of upward pressure upon the dam, thus neutralizing part of its weight, and inducing failure for lack of effective weight.

The determination of the perviousness of natural formations is very difficult, as any examination which disturbs them changes the conditions it is desired to know.

In general, it may be said that water will more readily traverse seams in rock or bedding planes than devious paths through the material of the rock. It follows that it will generally pass more readily and in larger volume in the direction of stratification, than in any other direction. Similarly stratified rock will permit percolation more easily and in greater volume than good massive rock, such as granite.

Granular rock, such as sandstone, is likely to transmit more water through the rock itself than one of finer grain or denser structure, like shale or limestone. Meyer states ("Hydrology" page 264), that granitic rocks usually contain less than 1 per cent of voids, limestone 1 to 5 per cent, and sandstone 6 to 25 per cent. The percentages of voids in clay and shale are greater, but the grains and the voids between them are so small that water moves through them with extreme difficulty and slowness.

No exact rules of this nature can be laid down, because there are many varieties of each kind of rock, with different percolating capacities. In general, however, the following rules may be taken as rough guides:

1. Massive or crystalline rocks such as granite gneiss and schists will transmit water less freely than sedimentary rocks.
2. Stratified rocks will transmit water more readily in the direction of stratification than transverse thereto.
3. In the direction normal to stratification, sandstone will generally transmit water more readily than limestone or shale.
4. Stratification on a plane approximately horizontal is the worst condition for introducing upward pressures beneath a dam. Conversely, the most favorable position in this respect for stratified rock is in nearly vertical beds.

As all rock contains some seams, and nearly all rock is more or less pervious, it is unsafe to assume that any foundation is entirely impervious. It follows that in every masonry dam, some provision should be made to prevent or counteract upward pressure of water in the foundation. The amount of this force cannot possibly be foreseen with accuracy, and under ordinary circumstances cannot be foretold within rather wide limits.

Any foundation for a masonry dam should be excavated to a plane below any surface disintegration. Where the foundation is seamy and pervious, a deep trench should be excavated along the heel of the dam to be later filled with rich concrete, thoroughly rammed and bonded with the masonry of the dam.

In the bottom of this trench holes may be drilled to a depth of 50 feet or more below the bottom of the trench, and by forcing into these holes cement grout under high pressure, seams and cavities intercepted may be filled and sealed against percolating waters. The drilled holes should be placed at intervals of 5 to 20 feet or more according to the conditions of greater or less permeability found to exist. The attempt is to form an impermeable curtain wall to a great depth, to prevent water from passing from the reservoir under the dam.

A short distance downstream from this cut-off curtain another series of holes or drainage wells should be provided

to intercept whatever water may find its way into the foundation. These should be about 6 inches in diameter, and 8 to 10 feet apart, along the entire length of the dam. The wells should be continued upward in the masonry to a drainage gallery just above the natural ground surface, which will discharge any water received into a cross conduit, leading to the open river below the dam.

If the foundation is of very good granite, or other relatively impervious rock with few seams, the cut-off and grouting precautions need not be as elaborate as those described, but the drainage system should be provided in any case of a high masonry dam, to insure against uplift in the foundation.

13. Exploring Foundation.—Before deciding upon the suitability of any proposed dam site it is necessary to ascertain the character of the foundation and the depth and character of the bed rock.

Where it is feasible to sink open shafts and test pits these are the most satisfactory means as they afford the opportunity of examining the material, in place, but they are expensive, and where water is to be encountered, may be impracticable or ineffective, and are very costly. Where the material passed through is to be used as the foundation of dam without removal so that its imperviousness is important, the material itself is not more important than the manner of its deposit, and test pits are the only satisfactory means of examining the material in place.

Where the problem is the depth and character of bed rock, without much concern as to the character of the overlying material, the most economical procedure is to sink an iron casing to bed rock and take cores from the rock by means of the diamond drill. The process of sinking of the casing is performed by two general methods, called the method of driving and the method of wash boring. In the driving method, the casing used is extra heavy steel pipe from 2 to 3 inches in diameter, cut to convenient lengths, which are fastened together by exterior sleeves. The bottom is shod by a short cutting bit of tool steel, and the top is provided with a solid head.

This pipe is driven like a pile, and the interior is occasionally washed out with a chopping bit on a smaller pipe, provided with a water jet. When bed rock is reached the chopping bit is used and the pipe driven until some penetration of the rock is secured so as to make a tight connection between the casing and the rock, and thus exclude sand and gravel. The diamond drill is then applied operating inside the casing, and circular cores of the rock are secured.

By the "wash-boring" method flush-joint pipe is used, which is not so strong, but sinks more readily than that with sleeve joints. The flush-joint pipe is not driven, but the chopping bit working inside is freely used with a strong water jet. The pipe is turned round and round by means of tongs, and sinks of its own weight or by weights resting on its top, following the hole made by the chopping bit which clears the way. This method is usually faster and cheaper than the driving method.

When the diamond drill is used, it may pass through the rock into sand and thus demonstrate that a boulder and not bed rock has been reached. In such a case a few sticks of dynamite are lowered into the hole drilled in the boulder, and after withdrawing the casing a few feet to avoid injury the cartridge is exploded electrically, and thus the boulder is shattered so that the casing may be sunk through it like gravel.

The diamond drill should be made to penetrate the rock to a sufficient depth to be sure that it is bed rock and not a detached boulder or fragment of rock, that is encountered, and if the rock is not of satisfactory character, the drilling should continue until better rock is reached, or the prospect of satisfactory rock disappears.

Drilling machinery like that described is manufactured in such a way as to be adapted to operation by hand, and separable into parts capable of transportation by laborers or pack animals. Where much drilling is to be done it is usually more economical to use heavier machinery with steam motive power.

Such a machine operated by hand is capable of drilling 200 feet into solid rock. It will make 5 to 10 feet per day in hard

rock and more in soft rock. By the use of steam machinery much faster progress can be made.

REFERENCES FOR CHAPTERS XVII AND XVIII

- CAIN, WM. Stresses in Masonry Dams. Trans. Am. Soc. C. E., vol. LXIV, p. 208, New York.
- THOMPSON, S. E. Impurities in Sand for Concrete. Trans. Am. Soc. C. E., vol. 65, p. 250, New York.
- JORGENSEN, L. R. The Constant-angle Arch Dam. Trans. Am. Soc. C. E., vol. 78, p. 685, New York.
- CREAGER, W. P. Masonry Dams. John Wiley & Sons, New York.
- BLIGH, W. G. Dams and Weirs. American Technical Society, Chicago.
- HARRISON, C. L. Provision for Uplift and Ice Pressure in Designing Masonry Dams. Trans. Am. Soc. C. E., vol. 75, p. 142.
- RANDS, HAROLD A. Grouted Cut-off for the Estacado Dam. Trans. Am. Soc. C. E., vol. 78, p. 447, New York.
- WEGMANN, EDWARD. Design and Construction of Dams. John Wiley & Sons, New York.
- JORGENSEN, L. R. Arch Action in Arch Dams. Proceedings, Am. Soc. C. E., May, 1918.
- SCHEIDENHELM, F. W. Reconstruction of Stony River Dam. Trans. Am. Soc. C. E., vol. 81, p. 907.
- MEYER, A. F. Elements of Hydrology. John Wiley & Sons, New York.

CHAPTER XIX

WATER RIGHTS

1. Nature.—The title to water is no less important than that to the land which is worthless without it. Water titles, however, rest upon different principles from those to land and personal property.

2. Riparian Doctrine.—The English Common law, upon which our own laws are based, recognizes the riparian doctrine, which vests in the owner of the land abutting on a stream, the right to have the stream flow past his land in perpetuity, undiminished in quantity and unimpaired in quality. He may use the water for domestic and milling purposes, but must return to the stream before it leaves his property, practically the same quantity of water unpolluted; otherwise he infringes the rights of the proprietor of the land below him on the stream.

This law was developed in England in a humid climate, and provided for the uses of water then and there common, but is not adapted to the development of irrigation, being antagonistic to the diversion and consumption of the water in the growing of crops. In consequence, the needs of irrigation give rise to a radically different set of rules for the control of water. All irrigated countries recognize the right to divert and consume the water in irrigation, and in fact, many streams flowing in arid regions are thus diverted and almost entirely consumed.

3. Doctrine of Appropriation.—In the United States the right to the use of water in irrigation originates in Federal Laws recognizing and authorizing such use. Most of the land of the arid and semi-arid region was originally public land, and under the riparian doctrine the ownership of streams was

an accompaniment of the ownership of the land. The necessity of diverting these streams to irrigate the land was early recognized and was provided for specifically by the passage in 1877 of the Desert Land Act, which required the irrigation of the land as a condition of ownership. This law was a dedication of the water by its owner to the uses of irrigation, and thus made all unappropriated waters of the arid region perpetually subject to appropriation for irrigation, except when expressly forbidden as in the case of navigable streams. Exceptions to this rule are the cases of streams running through large Mexican land grants which never belonged to the United States, and the public lands of Texas, which belonged to the State under the provisions of the act admitting that State to the Union.

Notwithstanding the Desert Land Act, and the need of irrigation, a number of the Public Land States have attempted to apply the riparian doctrine to the waters within their boundaries. This is particularly evident in those States which are partly arid and partly humid.

The first American attempt to assert State control over the use of water in irrigation was a statute passed by the State of Colorado in 1879. This law was a crude one, making diversion the test of appropriation, and ignoring beneficial use.

Adjudications under this law were made by courts of law, distant from the lands affected, and many absurd and extravagant claims were allowed. Many cases might be cited where allowances were made of over twenty times the quantity of water that could be beneficially used, and far in excess of the capacity of the ditches. The aggregate of allowances were many times as great as the flow of the stream in the irrigation season.

The incompatibility of the riparian doctrine with the needs of irrigation was recognized in the early development of irrigation, and the eight States which are entirely arid or semi-arid have all abrogated this doctrine, and have substituted the reverse doctrine of appropriation of waters. These arid States are Arizona, Colorado, Idaho, Montana, Nevada, New Mexico, Utah and Wyoming. There are eight other States, however,

which are partly arid and partly humid, where the riparian doctrine still prevails in the humid portion. Most of these States have the bulk of their population in the humid portion, where riparian rights are consistent with normal development, and where the inhabitants are unwilling to reverse their rules of property tenure and thus interfere with vested rights for the accommodation of a small minority or to encourage the development of a distant part of the State. In these cases the humid portion of the State was first settled, and as the needs of irrigation developed various attempts were made to reconcile the antagonistic riparian and appropriation theories.

In two States, Washington and Kansas, the problem was attacked logically, by statutory action applying different rules to the arid and humid regions. In Washington the principle of appropriation was applied to Yakima County alone, where the main irrigation interests lay, and in Kansas it was applied only to the region west of the 99th meridian, which is the arid portion of the State.

In California, Oregon, Texas, Nebraska, and South Dakota efforts were made to apply both doctrines and the result was a large volume of diverse and inconsistent court decisions, but mainly having a tendency to modify the riparian theory as derived from the common law in order to adapt it to the needs of irrigation. As an early step in this process, the right of appropriation was recognized in the owner of riparian lands, and he could apply the water to such area as he saw fit. Some decisions held that unless this right was exercised, it was liable to lapse, and another could appropriate and apply the water to beneficial use. Whatever the theory on which rights to the use of water in irrigation are founded, all of them recognize beneficial use as the indispensable condition of a permanent right; but this is a long and expensive process in most cases, and statutory protection is very desirable to protect investments until it can be perfected.

In the absence of statutory provisions, it is often the custom to initiate a water right by filing a notice at or near the point of diversion, and record this action in some county record.

Such claims are often made to quantities of water far in excess of the total normal flow of the stream, and should be controlled by engineering authority on behalf of the State.

Until recent years the title to irrigation water was in a very chaotic state, not only by reason of conflicting theories, but for the lack of definite statutory direction regarding the procedure to acquire and perfect a title to the use of water. In too many cases this has been left to the varying judgment of the courts and diversion and inconsistent rules and practices have been established.

More recently, however, many of the States have adopted codes recognizing the right of appropriation, and have defined the legal steps necessary to thus initiate a right, which, however, remains inchoate until perfected by the application of the water to beneficial use.

The insistence of all irrigation laws upon the application of water to beneficial use as a condition of title, constitutes a radical difference between water title and titles to land which may be perpetual and incontestable, without any pretense of using the land at all. Not only is beneficial use required, but the tendency is to make this requirement more and more stringent. A well established title to water may in most States be forfeited by abandonment, or by non-use for a specified time. In most cases, not only use, but a reasonably economical use is required. Although the quantity of water usually allowed by statute or by court decision is excessive, the principle is maintained that there can be no title to water to be wasted.

Some of the constitutions of arid States assert that the waters belong to the public. This is a fundamental denial of riparian rights, but is always followed by provision for the appropriation of water to private use. As soon as this is accomplished the assertion that the water belongs to the people becomes a fiction. Attempts are made to disguise this fiction by contending that the private title is not a title to the water, but only a right to use. But as this right to use is perpetual, and involves the right to consume the water in irrigation, with no

obligation to return it to the public nor to the stream, it is in reality an absolute title, limited only by the obligation to use it beneficially.

4. Appurtenance to Land.—Aside from riparian rights there are two distinct theories of the ownership of water rights. One requires the appropriation of a specific quantity of water to a specified tract of land. When it is desired to detach a water right from the land to which it is appurtenant, it is necessary to give a statutory reason, comply with certain statutory formalities, and secure official permission, at the same time attaching the water to certain other lands, so that, under this theory no water right can exist except as appurtenant to certain land. The other theory permits the separate ownership of land and water, and thus the ownership of water is more nearly analogous to that of land than under the requirement of appurtenancy.

Each of these forms of water right has its advantages and disadvantages. A separate owner of water may own no land whatever, and may lease the use of water to one land owner one year, and to another the next, so that conceivably some land may be left without water, and perennial crops may die, and the land may pass out of cultivation to the ruin of its owner. It is argued that this discourages permanent improvement; and while this is theoretically true, such results do not often follow in practice, as the delivery of water is limited by the location and capacity of the canal system, which cannot be conveniently changed. Permanent improvements and perennial crops such as fruit trees and alfalfa are abundant in Utah where separate ownership obtains. The possibility of the owner of water to deny its use on the land where it has been used, or by taking advantage of the farmer's needs to demand an exorbitant price, is to be avoided, and it is generally recognized that the doctrine of appurtenancy is the better public policy.

On the other hand, when a given quantity of water is attached permanently to a certain tract of land, it often occurs that after some years the land does not require as much water as has been attached to it, and the tendency is to continue the

excessive use of water to a disastrous extent; whereas, if the water right is owned separate from the land, although both titles may be and usually are in the same person, the owner has the incentive of self interest to spread it over all the land it will properly serve, to secure the maximum use, and thus to promote the economy of water, which is so desirable in an arid region.

This objection to appurtenant water rights can be removed by laws and customs limiting the water right to the quantity actually required for economical use, and basing operation and maintenance charges on quantity used so as to put the onus of economy upon the user. This is becoming more and more the practice, and with this, and other wise provisions to secure economy there can be little doubt that the appurtenant water right is to be preferred.

REFERENCES FOR CHAPTER XIX

- MEAD, ELWOOD. *Irrigation Institutions*. Macmillan Company, New York.
- CHANDLER, A. E. *Elements of Western Water Law*. Technical Publishing Co., San Francisco, Cal.
- JOHNSTON, C. T. *Some Principles Relating to Administration of Streams*. *Trans. Am. Soc. C. E.*, vol. 78, p. 630, New York.
- LEWIS, JOHN H. *State and National Water Laws*. *Trans. Am. Soc. C. E.*, vol. 76, p. 637. New York.

CHAPTER XX

OPERATION AND MAINTENANCE

THE operation and maintenance of a system of irrigation canals and laterals is a highly specialized activity, involving different branches of skill for different systems. All of them, however, involve human as well as physical problems. Some of the most successful operators have become so by experience on some large systems, without special training in any other branch of engineering, but there are advantages in a general technical training which appear wherever new problems arise.

1. **Personnel.**—Every irrigation system of considerable size must have both office and field forces, under the general charge of a single responsible head.

a. Manager.—The Project Manager should be responsible for the safe and permanent maintenance of the system, and also for its efficient and economical operation. In addition to ability in many various lines, he must be well equipped with experience, judgment, industry and tact. If he is deficient in any of these qualities he will not be successful. He should have an assistant manager of his own selection and in close touch with him, who can act in his place during his absence, and to whom he can delegate many of the details of management. They should alternate to a certain extent between office work and field supervision, so that one of them may usually be found at headquarters, and both will be familiar with the business of the project, in field and office. 6

b. Canal Superintendent.—A large project is generally divided into districts each of which is in charge of a superintendent directly responsible to the Project Manager for the efficient delivery of water and the execution of maintenance

work. He is provided with equipment for rapid travel, and is assisted by such canal riders and gate tenders as may be necessary. The Superintendent should be provided with a telephone in his sleeping quarters, and be subject to call at all hours in case of a break in the canal, or other emergency requiring his attention.

c. Canal Riders.—Each canal rider should be assigned a definite portion of the canal and laterals for patrol, and for delivery of water therefrom to water users. He reports to the superintendent every day by letter the water deliveries, and promptly by telephone any urgent matters of business concerning the condition of the works and the needs of the water users of his district. The canal rider must be an intelligent man, should have some agricultural training, and be able to keep neat, accurate records. He must be energetic and vigilant and possess sufficient tact to enforce rigid regulations without unnecessary friction. He must be able and willing to perform arduous physical labor in case of a break or threatened break in the canal. Some construction experience is very valuable to him. The canal riders should usually be employed the year round, being engaged in cleaning and repair work and bringing the records into shape during the non-irrigation season. It is good practice to select these men from among the water users, but they should give their time to the duties of canal rider. Canal riders must be able to make accurate measurements of small streams, and to use intelligently all apparatus employed for this purpose.

The canal rider should patrol his beat on horseback or with a small cart. A bicycle, automobile or motor cycle tends too much to distract his attention from the condition of the canal and its structures, which it is his peculiar duty to inspect. He should usually be provided with two horses to alternate on duty.

d. Hydrographers.—On large systems it may be advisable to have an assistant engineer skilled in all kinds of stream measurement, and in the installation and repair of apparatus for this purpose, to keep records of stream flow at points not

immediately connected with any canal rider's beat, to inspect such observations throughout the project, and to digest the results. Particular attention should be given to the measurement of canals and laterals at points where the results will show seepage losses, and furnish data on which to plan improvements and repairs.

e. Cooperation with Water Users.—One of the most important duties of all, from Project Manager to Canal Rider, is to keep in sympathetic touch and cooperation with the water users. The first duty of the project management is to give good water service, and by vigilance and activity prevent or promptly repair breaks, and thus obviate interruptions. This will go far to secure public confidence, but is not alone sufficient. A patient hearing should be given all complaints, and careful investigations should be made with a view to the removal of all just grievances, however small. Suggestions for improvements will often be made, and these should be carefully considered, and if not practicable, the reasons for not adopting them should be clearly explained. The project personnel should show public spirit and concern for the common welfare, even along lines not strictly connected with the project management. In every community may be found broad-minded and experienced men whose cooperation along progressive lines it is possible to obtain, such as improved methods of irrigation, drainage, proper selection and rotation of crops, road improvement, cooperative marketing and other measures for the common good.

By such a policy it is possible gradually to secure the confidence and cooperation of the water users, and it is possible to accomplish far more by cooperation than by antagonism.

2. Economy of Water.—The first duty of a project manager is to insure the protection and maintenance of the irrigation works. The second duty is to so operate them as to give reliable and efficient service to those entitled to their use. The third and most difficult, and consequently most often neglected duty he has to perform is to see that the water is economically used and not wasted.

The average water user knowing that water is a valuable

commodity is apt to regard it in the same light as he would regard money or any valuable commodity, and he feels the more he can get the better he is off, while in fact, however, from a strictly selfish standpoint, the reverse is more nearly true.

The excess application of water is often positively harmful to the crops that receive it, which would produce better with less water. If the surplus drains away it carries with it plant food in solution and impoverishes the soil. If it does not drain away but remains in the water table it soon raises this water table until it curtails the root zone in which plants can feed and limits production in this way. If it continues to rise it eventually kills all useful vegetation, and this condition continued forces to the surface whatever alkaline salts are contained in the soil and destroys its fertility.

In addition to all the above reasons it is to the interest of the country at large and in a broad sense to each irrigator to make the best possible use of the water supply, which in most parts of the arid region is the limit upon agricultural development. The area of land available for irrigation, and nearly worthless without it, is far in excess of the water supply available therefor, except in a few restricted districts.

The measures for securing the best use from the available water supply depend mainly upon the farmer himself, but such measures can be encouraged and promoted by the management not only by agitation and other educational methods but by methods of water delivery and the adjustment of rates of payment therefor.

The encouragement of water conservation is hampered by the necessity which exists of using more water upon new land than upon land which by cultivation and the incorporation of humus therein has been reduced to a high state of tilth. This is due to the extreme dryness of new soil in the arid region, the absence of humus and the lack of that homogeneity or mellowness which follows from cultivation and mingling of organic matter in the soil. The presence of organic matter or humus renders the soil more retentive of water and less subject both to evaporation and to loss of water into the water table.

Another reason even more important is the inexperience of the average irrigator. During the period of settlement when only a fraction of the land is in cultivation there is usually a large surplus of water available and this fact, together with the reasons above mentioned, make the practice universal of using more water on new lands than they really need, and a great deal more than they need at a later date.

As cultivation proceeds all these conditions are changed. The farmer to succeed must put humus into the mineral soils characteristic of the arid region and must by irrigation and cultivation break up the stratification and induration of the various constituents of the soil, making it more homogeneous and mellow. The irrigator acquires experience with time, and the wider use of water reduces the redundant water supply to an amount just sufficient for economical irrigation with all the land in cultivation. But in the meantime habits have been formed. Each farmer who has not achieved maximum results is apt to attribute at least a part of his failure to a fancied insufficient supply of water at some time in the season, whereas in reality such shortage as he may have suffered has been due not to lack of water but to inadequate cultivation.

It has been previously shown that soil kept in a thorough state of cultivation with the surface thoroughly pulverized at frequent intervals loses water much less rapidly than uncultivated ground. At the same time the lack of cultivation permits the growth of noxious weeds which extract large amounts of water from the soil and thus in two ways the water supply is exhausted and the crops actually suffer from drouth even though the amount of water applied has been sufficient for their economical use under proper conditions. Thus the farmers are apt to resist any attempt to cut down the supply of water as furnished during the early stages of development and the opinion of the manager or any other expert who advises greater economy is apt to be denounced as the vaporings of swivel-chair theorists, as against the experience of the practical farmer. The result is generally a continued over-application of water with attendant rise of ground water and acute seepage con-

ditions, calling for expensive drainage works in some regions, and a serious loss of plant food from the soils of other regions. One of the distressing results is that the farmer who uses water most lavishly may not perceptibly injure his land except from loss of plant food, which no one realizes, but the excess water he applies seeps to lower levels and waterlogs the lands of his neighbors who may be using water with a fair degree of economy. It thus often happens that it is difficult or impossible to induce those chiefly responsible for seepage conditions to join in the movement to correct them or to provide drainage works necessary for the salvation of the lower lands.

This creates a condition where the management is blamed on the one hand for shortage of water due to alleged inadequacy of the works to provide the lavish quantity used in the early days, and criticism of the builders of the project for the waterlogged condition and a demand that they provide drainage works.

The Project Manager must keep careful records of the water delivered and the acreage cultivated from the inception of the project, and also of the position and fluctuations of the water table, especially as this approaches the root zone of perennial plants. It is only by having complete records of this kind that the management can be equipped for the inevitable campaign of education, and the possible coercion that may be necessary to prevent the destruction of values in an irrigated valley.

As soon as feasible the practice should be established by charging for water in proportion to the amount used. This practice is not so easily inaugurated as may appear on its face.

In the first place it requires careful measurement of water thus irrigated, which involves considerable investment in measuring devices, and considerable skill and labor on the part of the operating force. The cost of this may be criticized by the water users to whom it is charged, and their resistance has prevented proper administration in many cases.

The full application of the principle without modification places a premium upon the non-use of water and consequently

upon the non-cultivation of the land which is the reverse of what is desired. On the other hand a project just being opened and having sandy soil with a porous subsoil may be difficult to irrigate without applying an excess quantity of water at very frequent intervals while other lands perhaps even more productive owing to different soil conditions may be served with a fraction of the quantity of water necessary on the sandy lands. If a uniform charge for water by quantity is established it may happen that in order to collect a sufficient sum for the operation and maintenance of the project, the price must be fixed so high as to be oppressive or prohibitive upon the owners of the sandy lands and thus more harm than good might proceed from such a rule. For these reasons much care and judgment must be exercised in fixing the rates to encourage economy of water and penalize its waste, without restricting cultivation or oppressing those who are unfortunately situated regarding topographic and soil conditions. It is obvious, therefore, that every individual project presents a problem or series of problems all its own which must be met and solved upon their merits.

The correctness of the principles here advocated are recognized and provided for in the United States laws applying to the United States reclamation projects. Section 5 of the Act approved August 13, 1914, provides as follows:

“That in addition to the construction charge, every water-right applicant, entryman, or landowner under or upon a reclamation project shall also pay, whenever water service is available for the irrigation of his land, an operation and maintenance charge based upon the total cost of operation and maintenance of the project, or each separate unit thereof, and such charge shall be made for each acre-foot of water delivered; but each acre of irrigable land, whether irrigated or not, shall be charged with a minimum operation and maintenance charge based upon the charge for delivery of not less than one acre-foot of water.”

This while establishing a principle, leaves wide discretion in the executive officers in applying the principle. To start with,

physical conditions make it necessary to collect a different total amount and different amount per acre upon each system in order to pay the cost of operation and upkeep. Different systems and different parts of the same system require different quantities of water for proper irrigation due to soil and climatic and other conditions, and this necessitates a different rate in order to raise a given amount of money.

Another important consideration not yet mentioned is the necessity of bringing some pressure to bear upon the irrigators to accommodate each other and meet the demands of the system concerning the time of application of the water. Where the charge is made by quantity there is a general tendency to postpone irrigation in the hope of rainfall or cool weather by which a little water would be saved, then a hot spell may cause wilting of the crops and everybody rushes at once to the management for immediate delivery of water. As no system can be economically constructed adequate to irrigate all the land at once, it becomes impossible to fulfill all these requests on demand, and inevitably some crops must go short of water during the critical time, and heavy losses may ensue. To avoid this the carrying system is overtaxed and the overloaded canals, attended by an overworked operating force, are apt to give way at the critical time and cause widespread destruction both to the lands devastated by the broken canals and to those that need the water thus suddenly shut off.

It thus becomes necessary to make rules by which a farmer must give several days' notice of his needs so that these needs can be adjusted to the carrying capacity available, and the tendency to concentrate the requests all at the same time must in some cases be counteracted by an adjustment of charges. It is therefore advisable in many cases to charge more for water during the peak of the season than at other times in order to induce earlier use of water and prevent overtaxing the system as above described.

Experiments have shown that a limited quantity of water delivered to growing plants during the earlier stages of growth yields better returns than the same quantity of water applied

at a later date. Furthermore, water applied early in the season is available for plant use throughout the season so long as it is within the root zone, while late irrigation often leaves the root zone charged with water after growth has ceased and the water is thus wasted, and perhaps contributes to raise the water table.

Still another reason is very important. Most projects are supplied by streams which yield a super-abundance at certain seasons, and decline to small dimensions at other seasons and must be supplemented by expensive storage works. To get the full value of the investment in storage works the requirements of economy are much greater during the season when stored water must be used than during the season of abundance when water may be running to waste. In most regions the spring and early summer is the season of abundance, and streams decline in July reaching a very small flow in August and September. In order to induce early irrigation and better conserve the storage supply it may be advisable to adjust the charges so as to encourage early use of water and penalize excessive application of storage water later in the season.

The law above quoted has been found adaptable to all of these varied requirements and the result is a wide variety of terms and rates, applied to the different projects and even different parts of the same project. In order to avoid penalizing the use of water it is customary to make a flat rate which shall apply to all the land whether water is used or not and which when paid will entitle the landowner to a quantity of water which is sufficient for economical irrigation under the most favorable circumstances. This secures the collection of a certain amount of money from every acre and thus insures the recovery of most of the cost of operation and maintenance. A moderate charge for additional water will make it to the interest of every man to use water with economy. This charge should be moderate until the limit is reached beyond which any application is unquestionably wasted; thereafter, the charge should increase rapidly and finally become burdensome so as to properly penalize the prodigal waste of water.

On the pumping tract of the Minidoka Project, Idaho,

where it is necessary to prevent a sudden demand from exceeding the capacity of the pumps in the peak of the season, the price of water is fixed, at 50 cents per acre-foot for deliveries on or before June 5, and at \$1.00 per acre-foot after that date. The high price is continued after midsummer on account of the use of expensive stored water in the late summer and fall. A minimum charge, however, of \$1.50 is made against each irrigable acre whether water is used thereon or not, and this charge is credited on payments for water under the acre-foot rates.

From long investigations and study of results in Utah, Dr. Widtsoe, President of the Utah Agricultural College, concludes:

“The Utah results would lead to the belief that where the annual rainfall is from 12 to 15 inches, a depth of water from 10 to 20 inches is best for ordinary farm crops, and that the best quantity lies nearer the smaller figure. A depth of 12 inches probably represents the average requirement of ordinary farm crops, providing the water is measured at the intake to the farm.”

3. Wanton Waste.—First of all, rules must be rigidly enforced forbidding wanton waste of water, such as allowing it to run at night without benefit, on account of the inconvenience of night work, allowing it to waste in large quantities from the lower end of the field, into the roads or waste ditches, and other similar practices.

a. Irrigation at Night.—In the early development of some valleys, while irrigation uses are small and the water supply abundant, the practice grows up of irrigating during daylight and at dusk turning the water into some draw or slough, and allowing it to run to waste until the irrigator is ready to resume irrigation the following day. In this way from a third to half of the water is wasted, and perhaps contributes to raise the water table and aggravate the need for drainage, which is almost certain later to become acute. This practice may be hard to break, and attempts to do so should be preceded by courteous explanations of the necessity for the reform. It is, however, necessary finally to do this, and all communities where good

results are obtained with a reasonable quantity of water, give the same attention to the control of water at night that they give it by day.

4. **Rotation.**—In some regions, especially in the early stages of development, it is the practice to deliver a constant flow of the average quantity to which the irrigator is entitled, and where water is abundant this delivery is often greatly in excess of the needs. As the owner of a small farm cannot give his entire time to applying irrigation water but must attend to other duties, it is obviously not practicable to use water economically in this way. Much better results can be had, higher economy attained and much time saved by delivering water at intervals in larger volumes. This practice also promotes important economies for other reasons as when a small quantity of water is turned on at the upper end of the field it is absorbed by the land first reached and progresses very slowly to the lower end, and before a sufficient quantity has reached the lower end of the field for proper irrigation a great deal of the upper end of the field has become over-saturated and water is flowing by gravity into the subsoil, finally to reach the water table and be wasted. Much higher economy both in time and water can be obtained by turning on a large quantity at once so as to cover the ground several inches in depth and while the water in contact with the soil is being absorbed the surface water is run rapidly toward the lower end of the field. The entire surface is thus soon wet and the irrigation of a given district is soon over and the water is carried to additional fields. If a farm of 100 acres is entitled to an average flow of 1 cubic foot per second, it is best to commute it into a flow of 5 to 10 cubic feet per second, deliver for one-fifth or one-tenth of the time; then by giving careful attention to the use of the water, irrigation is accomplished better and the irrigator has a major portion of his time for other duties, and while engaged upon them his neighbors are using water in a similar manner. Such a system requires turnouts, laterals and farm ditches constructed with rotation methods in view and these should be provided in the construction of an irrigation system.

It is necessary to use much larger heads for irrigation on very sandy soils where percolation is rapid than upon tight soils which require a great deal of time to absorb the requisite amount of water. It is also practicable to use much larger heads on comparatively level ground than upon steep slopes, and next to the skill of the irrigator, the grade of the land to be irrigated is the most important element in the limit of head which it is practicable to use.

The introduction of such a rotation system is a matter of considerable difficulty and it will be difficult to overcome the established habits and prejudices.

The rotation method of delivery of water is employed on the Okanogan System in Washington, the system being to allow a water user for one week double the amount of water which would be required for constant flow, and then one week without any water delivery.

This schedule is worked out before the irrigation season begins and each water user is notified of the dates on which he will receive water. The schedule is adhered to as nearly as possible, but numerous modifications have to be made to accommodate the irrigators.

The system as worked has been found reasonably economical of water and of labor, and is satisfactory to the water users.

The lateral system on the Salt River Valley, Arizona, was so designed as to deliver to each quarter section of land a head of 10 second-feet of water. For many years the custom was followed of delivering such head for a period of twenty-four hours in every eight-day period, seven days without water, and for smaller farms, a proportionately shorter time, with the same interval.

In 1912 the basis of charge was changed from the flat rate to payment for quantity of water used in order to encourage economy, and the rigid rotation system was varied, water being delivered in large heads, but instead of a regular rotation, deliveries are made in accordance with requests which are required to be presented twenty-four hours or more in advance of the need. From these requests, rotation schedules are made

up from day to day as far in advance as possible, and in most cases, it is feasible to deliver water in accordance with the requests made.

During the maximum demand for water, these requests frequently conflict to such an extent as to make their compliance impossible, and notice is served that the water will be delivered on a rotation system.

When a lateral is on a rotation basis, it is the custom to begin at the lower end and work up to the head of the lateral, giving to every water user a head from $7\frac{1}{2}$ to 10 second-feet for from twenty-four to thirty-six hours for each quarter section of land. Generally when the demand for water at any particular time has been greater than the capacity of the canal to supply, it is necessary only to advise the farmers that the canal will be placed on a regular rotation basis and the demand immediately decreases, the farmer being willing to wait a few days for water rather than have the canal placed on regular rotation.

The delivery head, however, is the same for both plans of delivery, and the method followed on the Salt River Project is very economical, both of time and of water. Most of the irrigation in Salt River Valley is done under the border method described on page 112.

Regardless of crops raised, the border system is the best method of irrigating porous soils, unless the ground is too steep for this method. On very rolling land, so steep that the flooding or border method is not practicable as a means of distributing water the furrow system is generally used. The furrows may be run on any grade desired between the steepest, directly down the hill, and a level line along contours. The more open the soil the steeper must be the slope of the furrows. This may range from about 2 per cent on open sandy soil where the water must be hurried across the field, to about one-tenth of this slope, or 2 feet per thousand for loam or clay soils where more time for absorption must be given.

5. Basis of Charges.—It is becoming more and more the practice to fix charges for operation and maintenance in accord-

ance with the quantity of water used, and to encourage economy by this means. To insure the collection of sufficient revenue for expenses, and also to compel those who do not cultivate their holdings to pay a proper share of expenses, it is best to establish a flat rate of charge per acre, which will entitle the irrigator to about the quantity of water necessary for economical irrigation, and then fix a reasonable charge for all additional water used. This has a tendency to encourage proper use of water and to penalize waste, but accomplishes little, unless accompanied by a system of rotation delivery, and careful night irrigation. The variety of human and physical conditions lead to widely various application of the above rules for charges.

The projects vary widely in many respects. Some are expensive to operate in proportion to the acreage served and some are cheap. Some have an abundant water supply, and on others the supply must be stretched to the utmost. Some have stored water, while others depend on natural stream flow. On some delivery capacities are rigidly limited by pumps, expensive tunnels, or similar works, while simpler projects are more generously endowed in this respect. Some have a reasonably uniform soil, while on others the soil ranges from heavy clay to coarse sand with gravel subsoil. Some have a growing season of 4 or 5 months while others range from 6 to 12. Some lands require but a small quantity of water for good results, while others require several times as much.

These varying characteristics occur in all conceivable combinations, and each project presents a distinct problem which must be considered by itself, and changes from year to year, as development progresses. The provisions applying the above law are given in Table XXIV, page 145.

6. Cultivation.—Experiments have shown that a vigorous growing crop transpires more water to the atmosphere than is evaporated from the surface shaded by such a crop, but the evaporation from the ground still remains very important unless it is assiduously cultivated. After each irrigation there is a tendency for the surface of the ground to bake under the

hot sun, except on very sandy soils. When this occurs, capillary attraction is very strong, and the water is rapidly drawn to the surface and evaporated. This can be remedied by thoroughly stirring the surface of the soil breaking the crust and providing a mulch of pulverized loose soil, which holds the moisture and reduces evaporation to one-half or one-third what it would be without such cultivation. This also kills the weeds and conserves plant food, by keeping the water in the ground a long time before taken up by the plants thus giving it time to dissolve the minerals of the soil which serve as food for the plants. Fresh water applied to a field can convey but little nourishment to the plants, especially of the mineral character, and for this reason it is much better to conserve water in the soil for a long time than to allow it to evaporate rapidly and irrigate with fresh water. It is important, therefore, to cultivate soon after irrigation as the surface is sufficiently dry for the purpose, and it is necessary for constant effort to be put forth to induce the farmers to do so.

7. Winter Operation of Irrigation Canals.—In semi-tropical regions it is usually necessary to operate irrigation canals the year round and it then becomes at times difficult to secure enough respite to afford opportunity for necessary cleaning and repairs. This must usually be obtained in short periods in the winter season between crops or immediately after rains.

In the extreme North the long severe winters make winter operation not only practically impossible but relatively undesirable; in middle latitudes, however, where six months of the year are frosty and irrigation is not required, it may be necessary, and on new projects usually is desirable, to have water available for domestic and stock use and the demand for this use is sometimes very insistent. Arguments are also advanced that winter irrigation is beneficial and is necessary also for sprouting of winter grain crops and the moistening of land for winter plowing.

The operation of canals through months of freezing weather is open to many objections:

1. It delays or prevents adequate cleaning and maintenance

work and therefore cripples the efficiency of the canals for their real purpose of summer irrigation.

2. Water held continuously in canals results in serious deterioration of the banks which, becoming saturated, freeze and by the expansion of the ice leave the banks more or less open and porous, increasing the dangers of seepage and sloughing.

3. It increases the leakage of the canals by extending this through the winter and thus results in increased seepage and rise of water table, tending to destroy the agriculture of lands under the canal or to add to the cost of drainage.

4. Irrigation works are not designed with a view to operation under frost conditions, and the effect of freezing upon concrete structures often causes rapid deterioration.

5. Irrigation canals do not ordinarily furnish water supply suitable for domestic purposes and their unavoidable contamination renders the water unsanitary and dangerous.

6. Live stock is much better off in winter when supplied with clean and wholesome well water at underground temperature, which conserves animal heat and health and saves much feed.

It is best, therefore, to provide supplies of well water for stock and domestic purposes as soon as practicable. Experience shows that after the first year or two most of the settlers provide themselves with domestic water supply of better quality than canal water if this is at all feasible, and the demand for winter operation is usually by a small minority of the settlers. But even where this is not so the financial and sanitary considerations involved are strongly on the side of closing the canals as early as possible in the autumn, thus giving plenty of open weather for cleaning and repairs and letting the banks dry out before the hard freezing weather arrives. The canals are then in shape to secure satisfactory results when opened in the spring.

This policy also has usually a beneficial effect on the ground water conditions, as the contribution of water from the canals is thus shut off. In some localities, where the water table is already high near the canals, they operate as drains for a time

after the water is shut out in the fall, and thus hasten the lowering of ground water which occurs during the non-irrigation season.

Where winter delivery is necessary the burden of operation cost should be borne by those who demand it, and deliveries made only to those who share the expense. This problem is met on one of the Government systems by the following regulation:

a. Optional Water Service.—Until further notice, after October 20 of each season no water will be furnished except upon request, and at an additional charge for each farm-unit of eighty acres or fraction thereof, of \$2.00 for each day of water service given. Provided, however, that every person desiring this service shall, before receiving same, deposit with the Special Fiscal Agent of the United States, a sum of money sufficient to cover the number of days that he desires water and designate the turnout where he wishes to have the water delivered and the size of stream he will require. So far as may be practicable, water will be delivered to each depositor for the days covered by his deposit, but whenever the aggregate deposits for any day are less than \$200, delivery of water will cease and will not thereafter be resumed. Any unused deposits will be returned to the persons by whom they were made. This service will not be commenced, however, unless deposits aggregating \$200 per day for a reasonable period shall be made prior to October 20.

8. Maintenance.—An efficient rotation system will give occasional opportunities during the irrigable season for necessary cleaning and repair work on small laterals, and the opportunity to perform this work when most convenient or economical is an important advantage of such a system. This, however, cannot apply to the main canal, nor to the larger laterals, which must be used throughout the summer. In Southern Arizona and California the demand for irrigation water throughout the year presents a difficult problem in maintenance and repairs, and great care and energy are essential to perform these necessary duties properly, without seriously interfering with proper irrigation. The demand for water is much less in winter than

in summer, and a brief shortage produces less disastrous results. Such work as can be done with water running in the canals, is so performed, and the rest is, if possible, postponed till the fall or winter months. By closing one large lateral at a time after due notice to the irrigators, concentrating a large force there and pushing the work, the annual maintenance work may usually be performed on these with little inconvenience to anyone. The main canal is treated in the same way, selecting for this the period of least demand for water, usually in January.

In more northern latitudes with shorter season, the water should be turned out of the canals after ample notice to everybody, as early in the fall as conditions will permit, and a strong force previously organized should immediately be set to work to perform the annual maintenance work. A careful inspection of the canal and all structures should be made, and their condition recorded for present and future use.

9. **Erosion.**—Where erosion of one bank is noted, this should be attended to. If it is due to some obstruction on the other side of the canal as a sand bar or other drift this should be removed. If the erosion is on the outside of a curve in the canal this may be corrected by deepening the canal on the inner side of the curve, to induce a stronger current on that side, and using the material removed to flatten the slope on the opposite side. If gravel can be obtained a carpet of this may be placed on banks showing moderate erosion. In case of necessity the points attacked may be protected by riprap of rock, or in some cases sage brush had better be employed.

Rock riprap has been much used, but is always costly and is not efficient unless laid in a very expensive manner. Unless the riprap is started below the canal bottom and the joints well plastered, it soon fails in sandy soil by the washing out of the sand between the cracks. Brush of any kind, weeds and grass will do temporarily, but the latter are good for but one season. Sage-brush is especially adapted to this purpose, being bushy, flexible, durable and tough.

A method extensively used is to plow a deep furrow in the bank about a foot below where the damage is likely to occur

and smooth this out with a small V-shaped scraper which leaves a terrace about $2\frac{1}{2}$ feet wide. On this a layer of brush is placed with butts to the bank and tops sloping toward the water and downstream 30 to 40 degrees, the tops being kept in careful alinement. After the first row has been laid, another furrow is plowed higher up the bank and smoothed out with a scraper, pushing the dirt over the first layer and effectively binding it without the use of stakes. This process is repeated until the riprap is a foot above the maximum water surface. When finished, the tops of the brush should extend 8 inches beyond the earth they are buried in, but must not encroach upon the original canal section.

The distance vertically between layers of brush and the density of each layer should vary with the velocity of the water. For velocities below 3 feet per second, the density of the riprap may be about equal to that of the branches in the average sage-brush, and this should increase with higher velocities.

On the Minidoka Project a large amount of such riprapping was done at costs varying from 10 to 14 cents per square yard.

10. Silt Deposits.—Accumulations of sand or silt should be removed and their cause noted. If it is due to some local obstruction producing an eddy or other removable cause, this should be corrected.

Dead weeds drifting into the canal should be removed and burned. Weeds, brush and grass growing in or very near the waterway will obstruct the flow and cause deposits of silt, and should be removed. If this is done cleanly annually or oftener it will be less expensive than if postponed until the nuisance becomes acute.

Where excessive seepage has occurred it may be advisable to excavate the channel larger and refill with clay puddle. This method is described on page 233. Where the water carried is heavily silt-laden, extensive deposits of silt may occur throughout the canal system, and must be removed by mechanical means. This is done from small canals in the southwestern valleys where this problem occurs, by means of a V-shaped drag or plow with a cutting edge, pulled by one or more traction

engines. It is necessary for the V to travel down each side, and it is not applicable to canals of more than 10 feet bottom width nor 4 feet depth. Larger canals may be cleaned of silt by dredges traveling on the banks, or floating on barges. The drag line type is best adapted to this use.

11. Alkali.—In some regions concrete is attacked and slowly disintegrated by alkali, usually sulphates. The damage is generally caused by alkaline ground water, which is absorbed by the concrete, whence the water evaporates leaving the salts to crystallize in the body of the concrete, and disintegration follows, apparently as a mechanical result. The structures usually attacked are those in contact with the ground on one side, and with the air on the other, such as culverts, and canal linings while not covered by canal water. A structure standing in alkaline ground may absorb ground water, which by capillary attraction percolates upward, and evaporates from the surface above ground, and disintegration begins just above the ground, and extends as high as the ground water rises. The preventive most often attempted is to make the concrete as dense as possible by careful mixing and placing, so as to reduce its absorption to a minimum. It may be that a coating of tar or other waterproof material can be placed on the side next the ground water, and this may prevent attack. Another method, applicable to canal lining and some other cases, is to drain the ground water from the vicinity of the concrete by a layer of screened gravel, leading to some escape.

12. Growth of Aquatic Plants.—Where clear water is run in earth canals, especially at a low velocity, the growth of aquatic plants sometimes reaches a profusion that gives serious trouble. There are several species of these plants some of which have long stems, and by friction upon the flowing water, impede the velocity and thus cut down the capacity of the canal until it often becomes imperative to remove the vegetation in order to restore sufficient capacity for the needs of the crops. Such growths seldom become troublesome when the water is continuously turbid, nor under bridges where the shade is dense. They are more troublesome in shallow than in deep canals,

and do not thrive generally, in water more than 4 or 5 feet in depth. They need sunlight and heat, and seldom bother when temperatures of water are kept below 65 degrees. They are especially troublesome in canals of low velocity, although when other conditions are favorable, they occur in canals with velocity as high as $2\frac{1}{4}$ feet per second.

The experience of the U. S. Reclamation Service indicates that the velocity should be at least $2\frac{1}{2}$ feet per second to insure against troublesome growth of aquatic plants. Etcheverry concludes from study of all available data that instances of troublesome growths in velocities above 2 feet per second are few and practically none for velocities greater than $2\frac{1}{2}$ feet per second.

Numerous methods of combating these pests have been tried from time to time, with various degrees of success.

Where the climate is especially hot and dry the plants are sometimes killed by shutting the headgates and allowing the water to drain out of the canals and laterals affected, which dries the plants and kills them in from two to five days under favorable conditions. This will not work, however, where the grade of the canals is slight as the water is then held by the plants as a sponge, and does not drain sufficiently to kill the plants in a reasonable time, but where the grade and velocity are ample and the humidity low it has been known to succeed. It seems to be more effective with some species than with others.

Aquatic plants do not grow to a harmful extent in muddy water, and where the conditions are favorable benefit may be derived from an application of the silting process, so as to keep the water muddy for several weeks. To be effective, this remedy must be applied before the plants have reached any considerable size and vigor, and should be continued until its effect is complete.

Where neither of these means can be successfully used, the plants may be removed by mechanical means. Several devices have been tried for this purpose.

A small chain to which are attached lead weights has been dragged along the bottom of the canal by a team on each bank

attached to the ends of the chain. Little success has followed such efforts, as the chain slides over much of the vegetation without killing it. A springtooth harrow is rather effective in small laterals where the water is not over a foot deep, but has to be frequently cleaned, and is a failure in larger canals. Brush scythes wielded by hand can also be successfully employed in small laterals.

The most effective weapon in large canals is the submarine saw, which consists of a flexible steel tape with teeth on both edges, and is pulled back and forth across the bottom of the canal by a man on each bank. It has lead weights to hold it against the bottom, and a rope handle is attached to each end. The work of sawing progresses against the current of course, the saw is operated at an angle of about 30 degrees to the cross-section of the canal, and the pull toward the upstream end does the cutting. The vegetation when cut rises to the top of the water and floats downstream, where it is taken out at the first bridge by one or two men with pitchforks. One crew can progress at the rate of from 1000 to 5000 feet per day. The cutting is effective at the time, but does not injure the roots, which often send up new shoots which grow rapidly and it may be necessary to repeat the process two or three times in a season. This method is not effective unless there is enough current in the canal to hold the plants firmly against the saw.

Where the canal is free from stones and gravel good results may generally be obtained by the use of the Acme harrow, or orchard cultivator, a machine consisting of long parallel blades attached to and following an iron frame, with the sharp edges of the blades turned to a horizontal position. It cuts the roots just below the surface of the ground, and the plants float to the top of the water and pass downstream to the first structure where they are removed with pitchforks. The cultivator is drawn by means of long chains, by a team on each bank of the canal. By adjusting the length of the chains the machine can be made to work on either side or bottom, of the canal. Results are obtained much cheaper with this method than with the saw. Where there is a tendency to silting this machine

stirs up the silt which is then carried along and deposited upon the land, while the muddy water tends to retard the growth of the aquatic plants, and helps to puddle leaky stretches of the canal. Where conditions permit, canal velocities of $2\frac{1}{2}$ feet per second and over should be provided, and if grades sufficient for this cannot be secured, it may be advisable to provide a canal depth of 5 feet or more, remembering that the narrow deep canal will have a higher velocity on a light grade than a shallower one, and that both velocity and depth tend to prevent trouble with aquatic plants.

The narrow deep canal having a higher velocity for a given grade, and deeper water for a given capacity, presents for both these reasons greater security against the growth of algæ or other aquatic plants.

13. Wind Erosion.—New canal banks built of sand or other light soil in a windy country are often attacked by wind, and may be gradually destroyed unless protected in time. It may be necessary to provide a blanket of gravel or clay if these are obtainable, but this may be too expensive, and in any case it is desirable to clothe them in vegetation, and this should be undertaken as soon as possible in order to forestall wind erosion. The natural vegetation, the climate and the soil involved should be carefully studied and in many cases it may be advisable to sow seeds of plants that will grow under the adverse conditions, and yet not become a nuisance. In most parts of the West, the Russian thistle appears spontaneously after a time, unless the climate is too dry and hot. This plant protects the soil from wind erosion, wherever it thrives, but becomes itself a nuisance in the fall, by breaking off at the ground and blowing across country as a tumble weed, lodging against structures, clogging turnouts and even obstructing the canal itself. A pile of these weeds becoming waterlogged in the canal will sometimes collect silt and other drift, thus forming bars which reduce the capacity of the canal, and perhaps divert the current against the opposite bank, and start erosion. Nevertheless even this thistle is often a welcome assistant against wind erosion, on account of its persistence where nothing else will

grow. Rye is sometimes sown, furnishing valuable protection, and reproducing itself under rather unfavorable conditions. It has the important virtue of never becoming a nuisance. Care should be taken to avoid semi-aquatic vegetation such as willows and various water-loving grasses, which will encroach upon the water section of the canal, collect sediment and gradually reduce the capacity of the canal. Some of these plants are very difficult to check and control when once started, and are most apt to give serious trouble in canals of low velocity.

14. Noxious Plants.—It is not always possible to draw a definite line between plants which are helpful and those which do more harm than good. In general the control of weeds on the canal banks is a serious matter, and a constant expense in maintaining the canals at their required capacity.

Various methods of fighting weeds and grasses on the canal banks are employed, such as mowing them frequently, cutting below the ground surface with hoes or shovels, and sometimes where the problem is most difficult sheep and goats are successfully employed by confining them on the canal banks with fences. They must be furnished in sufficient numbers so that they will be constantly hungry and keep all the weeds cropped close to the ground, otherwise they will choose those they like best, and let others grow. This method has been successfully employed in Southern Arizona, New Mexico and Texas in controlling Johnson grass, willows, and other persistent weeds.

15. Burrowing Animals.—The maintenance of a canal system is a perpetual warfare between the manager and a horde of burrowing animals, such as gophers, ground squirrels and muskrats. The newly built banks offer favorite locations for their holes, and where one emerges on the canal side below the water line the water follows it and quickly enlarges the hole until it becomes a break carrying all the water of the canal, and sometimes causing great damage not only to the canal, but to the irrigated crops and to the land itself. One of the most important of the duties of the canal rider is to scrutinize the banks for signs of burrowing animals and when found, place grain, raisins, or other food thoroughly soaked in poison

at and near the entrance to the hole, and mark the spot so that it can be readily found again.

Various forms of traps have been devised which are sometimes employed with efficiency, and small rifles and shotguns have been used. It is absolutely essential that these pests be held in check, or it becomes impossible to operate the system with safety.

16. Land Slides.—Where a canal is located on sidehill it frequently gives trouble in inducing land slides. These may be of two kinds. On a hillside where the natural slope is steep, the cutting for the canal may remove so much material as to leave what remains in an unstable situation, with a tendency here and there to slide into the canal.

The other form of slide is that resulting from the saturation of the lower bank of the canal, inducing it to move away from the canal channel. Both types of slide are promoted by moisture, which in the case of the latter is furnished by the canal, and therefore most likely to happen in the summer. The first type or upper slide is more likely to become and remain saturated in early spring while snows are melting, and may therefore occur before the beginning of the irrigation season. In fact, a full canal has some tendency, by its weight of water, to balance and retard a slide from above.

Since both types of slide are promoted by saturation of the material, it follows that the provision of good drainage is in some degree a remedy. If ponds occur above the canal they may have a tendency to promote sliding, and drawing them off by adequate drainage may be sufficient to prevent this. The same may be said of any system of surface or subsurface drainage which tends to prevent the saturation of the material above the canal, or of any stratum therein.

The probable occurrence of slides from above is often the factor that determines the infeasibility of building and maintaining a canal on any given sidehill, and conditions should be carefully studied before deciding this question.

In order to counteract the weakening effect of the cut in the material it may be advisable in some cases to provide a canal

section or some rigidity, as a concrete flume or pipe which can transmit the pressure from above to the lower bank, and to the ground under the conduit, which thus serves as a retaining wall. Such a device was employed for this purpose on the Tieton Main Canal (Fig. 119).

Where there is danger of sliding of the lower bank this may be diminished to a large extent by lining the canal with concrete, and for this reason and the further reason that the lined canal by reason of diminished friction will carry the required amount of water with less cross-sectional area, and will, by preventing seepage save valuable water, many sidehill canals are lined when first constructed, and many others are lined later, as a maintenance precaution. But when done as an afterthought, there is loss of economy.

The character of the soil most affected by saturation is clay, some forms of which become semiliquid, and have very little stability when in that condition. Certain strata on which the bank rests may be of material which is rather porous overlying other strata which while not so porous, become unstable when saturated, and act as lubricants on which the overlying bank can readily move. If these strata dip down the hill, we have favorable conditions for sliding, and it may be that they make a proposed canal location infeasible, and that it will be necessary to build a flume or tunnel to avoid danger. This is especially true where the location is above a railway or other valuable property that would be damaged by a canal break. In doubtful cases the condition may be materially improved by providing deep tile drainage to prevent saturation of the treacherous material. The only remedy for sliding is to prevent saturation.

REFERENCES FOR CHAPTER XX

- HARDING, S. T. *Operation and Maintenance of Irrigation Systems*. McGraw-Hill Book Company, New York.
- NEWELL, F. H. *Irrigation Management*. D. Appleton & Co., New York.
- BROWN, HANBURY. *Irrigation, its Principles and Practice*. D. Van Nostrand Co., New York.

CHAPTER XXI

INVESTIGATION OF A PROJECT

1. Reconnaissance.—To investigate the feasibility and cost of a proposed irrigation project it is necessary to consider all the various factors affecting the probability of the existence of a feasible project.

First, is there a sufficient area of good land, apparently accessible to the water supply? If this seems doubtful it may be necessary to make reconnaissance surveys, to ascertain how much land can be reached, and its general quality. Before much expenditure is incurred for this purpose, however, inquiry should be made into existing data regarding the water supply, for if this is scanty or precarious, further expenditure may be unwarranted.

If a reconnaissance shows ample good land fairly smooth, an apparent water supply without storage, or a storage site if necessary, with no obvious insuperable obstacles in the way of putting the water on the land, surveys may be started to measure the water supply and determine the cost of controlling and bringing it to the land.

2. Surveys.—Early attention should be given the water supply. For unless a long record of stream flow kept by the government is available, or the water supply is a great river far more than the needs of the project, the measurements should begin as soon as possible, for they must continue several years to be a safe guide. One or more gaging stations should be established, and continuous record kept.

Students of water supply problems are often misled by formulæ for computing runoff from data upon rainfall, evaporation, etc., put forth by over-confident authors, or derived from

observations of totally different conditions. Nothing must be allowed to take the place of actual measurements of the stream.

If the data available indicate that storage will be necessary to provide a sufficient supply of water when needed, the existence, capacity and cost of storage opportunities must be carefully investigated. If these are wholly or partly in private ownership liberal allowance must be made for their purchase, and this is an expense that is difficult to forecast, and is commonly underestimated. Careful examination should be made of the dam site, especially the character of its foundation and abutments and the available material for construction. The amount of sediment carried by the stream should be considered with reference to its effect on the life of the reservoir, and if considerable should be carefully measured. These measurements can usually accompany the measurements of the stream and add very little to the cost.

A topographic survey of the reservoir site or sites should be made, in 10 foot contours if the reservoir is deep, and closer intervals for shallow reservoirs. The scale may be 2000 feet to an inch for very large reservoirs, to 500 feet to an inch for small ones.

The dam site should be mapped on a scale of 100 feet to an inch or larger, in 5 foot contours if precipitous and 1 or 2 foot contours if the slopes are gentle.

Careful examination should be made of the rock and other material with reference to its suitability for abutments and foundation, and its availability for construction purposes. If the funds are available and construction seems probable examination by means of test pits or borings should be undertaken. As a thorough exploration of this kind is expensive, it may be wisest to confine preliminary investigations to a few test pits at first, until more expenditure appears warranted.

Examination of diversion facilities should be made early, as these may have an important bearing on the cost and feasibility. It is desirable to divert the stream at such an elevation that the canal will deliver the water by gravity flow along

the upper edge of the land to be irrigated. This may be sometimes attained by a diversion sufficiently upstream to achieve this, or if the grade of the stream is moderate and good dam sites appear, it may be best to build a diversion dam of considerable height to raise the water to the necessary elevation and lead the canal from that point. In this way heavy canyon construction may sometimes be avoided. Surveys of all promising alternatives should be made and compared before decision is reached.

Involved in the above alternatives may be different elevations on which the canal may be located. It may be that to command all the irrigable land by gravity will involve an undue amount of heavy construction, and economy will require a canal location on lower and smoother ground, leaving certain tracts of land above the canal to be abandoned or perhaps eventually to be pumped upon. Trial lines may be run to test various alternatives, and if these are numerous it may be wise to make a topographic contour map of the country under study, on which all alternatives may be examined before making any very detailed survey. On such a map, such alternatives as those of tunnel and open canal, flume and inverted siphon, and the like, may be compared. It also furnishes the preliminary information for planning a distribution system.

When the main canal line is decided upon, a detailed contour map is advisable for estimating quantities. On this map the character of material to be moved should be shown, whether rock, shale, sand or clay, so as to give a correct indication of the probable cost of excavation.

This detailed map, the general topography map, and the borings at the dam site, are all rather expensive details that are not justified unless most of the other serious doubts of the feasibility of the project have been removed. A detailed soil survey of the irrigable land is to be desired before construction is begun so as to determine the area of good land available, and its water requirement. However attractive the water supply and the engineering features of the project, the returns must depend on the area and fertility of the lands from which crops

may be secured. This information is therefore just as important as the water supply, and it is as often overlooked or over-estimated.

The character of the crops to be raised and their market are important factors, and these may depend upon railroad facilities to a large extent. All these must therefore be given due weight in estimating prospective returns.

3. Estimates of Cost.—At every stage of the investigation it is necessary to make tentative estimates of cost, for comparison of alternatives, for elimination of unpromising features, and for forecasting the ultimate outcome, so that unnecessary expenses in surveying an infeasible project may be avoided. These preliminary estimates may be controlled by unit prices adopted for all, which may serve their purpose fairly well though not accurate, provided the different items of cost bear the correct relations to each other. But when it comes to the estimate on which the feasibility depends, it is important that these unit prices and all other items of cost be not only relatively but actually as accurate as possible, and this presents a problem of great difficulty in many cases.

The tendency to underestimate construction costs is nearly universal. Even in the construction of a building in a city, where the materials and processes are well standardized, labor conditions are stable and well-known and daily experience furnishes abundant data for estimates, the owner generally finds when his house is finished it has cost more than he expected. But when new conditions are encountered, and the multitude of variations in materials, transportation and labor conditions are involved, this tendency is greatly intensified, and nearly always, costs exceed the estimates, unless great effort is made to make these liberal. There are several distinct causes for this tendency to underestimate costs.

a. Bias.—There is no attempt here to consider dishonest estimates made with a deliberate or conscious purpose to present an attractive showing calculated to favorably influence investors regardless of the facts. We are now dealing with the influences that bias honest effort. Everyone has a natural

desire that work he has done achieve some result. The investigations would generally not have been started except for the existence of a strong belief that a feasible project would be developed, and thus exists a strong if unconscious desire that the investigation shall result favorably.

b. Influence.—There frequently exists also, a strong desire on the part of someone interested in the results, who is in touch with the inquiry, who continually presents arguments and facts favorable to cheap construction and large returns, which are likely to have considerable influence on the most judicial mind.

c. Inaccurate Data.—The estimator's principal guide is previous experience. So far as this is his own, and intelligently used, it is the safest possible guide, although subject to the limitations of careful and discriminating use. But usually, the engineer must depend less upon his own personal experience than upon the records made by others, and here he is upon dangerous ground, for these records are mostly one-sided. Where work has been performed very cheaply, it is the subject of boast or exploitation, and its cheapness is often greatly exaggerated by the omission of such charges as plant cost, overhead, preliminary work, etc. Reports of unit costs are often selected from the most favorable periods of work, thus omitting expensive delays, repairs or other contingencies, and may thus be less than half the average actual cost. Where reports of excessive costs accidentally become public, they are generally accompanied by explanations of unusual difficulties, abnormal conditions, storms, accidents, or the stupid blunders of someone else; contingencies not to be expected again, so that large or even average costs are thus discredited and attention focused upon those that are the minimum, whether reliable or not. For these reasons, cost data are often very misleading.

d. Omissions.—One of the commonest errors in estimates is the omission of certain elements of cost, owing to the inherent difficulty of foreseeing everything. This applies not only to

unforeseeable expenses but those which could be easily foreseen but were overlooked or forgotten.

For these reasons, the beginner should understand that the path of the estimator is beset with pitfalls which he must be careful to avoid, and he should be cautious about accepting current opinions or even published records of cost until these have been verified and their completeness and reliability established.

CHAPTER XXII

SPECIFICATIONS

It is important to have clear, concise specifications covering engineering work required, and they should be as specific as conditions will permit, leaving a minimum of discretion with the engineer. The important points are to cover the subject thoroughly, and avoid ambiguity or possibility of more than one obvious meaning. The samples here given are in the main those evolved by fifteen years' experience on large works by the U. S. Reclamation Service, and their provisions have been thoroughly tested. It is not intended, however, that they be used without modification, but only as a guide for drawing specifications adapted to local conditions in each case.

The above applies especially to work let by contract, for which written specifications are obviously necessary. It has also been found advisable, on large works, where construction is performed by the direct method of hired labor without the intervention of a contractor, to draw similar specifications for the guidance of the engineer in charge and his subordinates, where the superintendent of construction occupies a position in authority similar to that of a contractor, and although under the orders of the engineer, is held independently responsible for the construction forces and their work. In this manner the Lahontan Dam in Nevada, and the Arrowrock Dam in Idaho were built. The specifications of the latter are given as a sample of how this work was performed. There are also presented standard specifications for some of the most important work required in irrigation.

SPECIFICATIONS FOR ARROWROCK DAM

GENERAL PROVISIONS

1. *The Requirement.*—The purpose of the work covered by these specifications is the construction of a masonry dam and its appurtenant features across the Boise River at Arrowrock, in section 13, T 3 N, R 4 E, about 20 miles east of Boise, Idaho.

2. *List of Drawings.*

1. (14,302) General map and plan of construction works.
2. (14,303) Cross-section of dam.
3. (14,304) Plan of dam.
4. (14,305) Elevation of developed upstream face of dam.
5. (14,306) Plan and sections of spillway.
6. (14,307) Typical sections of diversion tunnel.
7. (14,308) Cross-sections of north wing walls at tunnel inlet and outlet.
8. (14,309) Cross-sections of south wing walls at tunnel inlet and outlet.
9. (14,310) Cross-sections of cofferdams.

3. *Organization.*—The work covered by these specifications is authorized by the Secretary's order dated January 7, 1911, and shall be done with Government forces. The Director of the Reclamation Service, through the supervising and construction engineers and superintendent of construction, will purchase all materials, equipment and supplies and will employ all labor necessary for the construction and completion of the dam and its appurtenant features. A scale of wages shall be fixed from time to time by the supervising engineer, after having received suitable written recommendations covering such scale of wages from the construction engineer and superintendent of construction. The supervising engineer shall divide the organization as would be done if the work were to be performed by contract, into the engineering division, under the direction of the construction engineer, and the construction division, under the direction of the superintendent of construction.

The duties of the engineering division shall be similar to those of the engineering force on contract work; the principal duties of this division being to make estimates and designs for the works and to see that the works are built in accordance with the plans and specifications, and this division will be held strictly responsible for this feature of the work. This division shall also give the construction division such help as may be necessary in getting out designs and estimates for the construction plant. For the purpose of executing his duties, the construction engineer shall organize office and field engineering corps that shall report directly to him. All work, other than clerical, in connection with the construction, maintenance and operation of the Arrowrock Railroad, the power house at the Boise River Diversion Dam and the transmission line leading therefrom to Arrowrock shall be under the charge of the construction engineer.

The duties of the construction division shall be similar to those of the construction force on contract work; the principal duties of this division being to provide methods and plans for actually executing and building the works and to construct the work. This division will be held particularly responsible for the

progress and cost of the work. In any work on designs and estimates for the construction plant that, under contract work, would be done by the contractor's engineering forces, the construction division shall be assisted as much as may be necessary by the engineering division. The superintendent of construction shall select his foremen and principal assistants, who shall report to him, and he will be held responsible for the efficiency of the entire construction force. He shall detail one man as costkeeper, who shall obtain from the clerical and engineering forces all data necessary for compiling the required reports of costs. At the end of each calendar month the costkeeper shall furnish the construction engineer (with a copy to the supervising engineer) a detailed statement, certified by the superintendent of construction of all costs, including estimated apportionment of general expenses, depreciation, unit costs of work done, etc.

The supervising engineer's office at Boise shall handle all advertisements, purchases and vouchers covering materials and supplies for use in the construction of the dam, and the chief clerk of the supervising engineer's office shall be responsible for all clerical work. He shall conduct the clerical work in such a manner as to relieve the engineering and construction divisions from the necessity of occupying their time with clerical matters. The chief clerk shall detail any clerks who may be necessary at Arrowrock or other points on the Storage Unit, and these employees shall be responsible to him in connection with clerical matters, but shall be subject to the orders of the construction engineer or superintendent of construction in connection with administrative matters. Pay rolls shall be made up in the supervising engineer's office, based on time books certified by the superintendent of construction and transmitted from Arrowrock, and the fiscal agent at Boise will pay all employees, including those receiving time checks.

4. *Reports and Estimates.*—At the end of each calendar month the engineer shall make an approximate estimate of the work done to that date, and these estimates shall be prepared with the same degree of completeness as would be required in the case of contract work. As soon after the end of each calendar month as possible, a complete approximate cost report shall be prepared as outlined in paragraph 3 and transmitted to the supervising engineer's office with the construction engineer's regular monthly report. Upon the completion of each feature, a detailed report of that feature shall be prepared and shall include a complete history of the feature and a final estimate of quantities with total and unit costs.

5. *Progress of Work.*—Work shall be commenced on such features as wagon roads, telephone lines, etc., within thirty days after the authorization of construction, and the work on main features, the dam and its appurtenant structures, will be begun as soon thereafter as practicable. The diversion works will be completed to such extent that water may be diverted from the present river channel immediately after the June floods in 1912. Work of excavation in the river channel shall then be begun and the work will be prosecuted with all practicable speed until the concrete in the dam shall have been placed to about elevation 3000. After that time the rate of progress shall be as great as is consistent with proper economy, and as the apportionment of funds will permit.

6. *Cement.*—All Portland cement shall be purchased through the cement expert of the U. S. Reclamation Service at Denver, Colorado, and shall be inspected under his direction before shipment. The same care shall be observed in the unloading, storing, and safe keeping of the cement, and for the return of the full number of

cement sacks to the railroad station in serviceable condition, as is used on construction work under contract. Upon the delivery of the Portland cement at the dam site, it shall be reground with granite or other suitable material to form sand-cement, which shall be used throughout the dam, spillway weir, and lining, in the same manner as Portland cement, unless otherwise specifically ordered by the engineer. Hereafter in these specifications the term "sand-cement" will signify the product of regrinding Portland cement with suitable blending material in proportions fixed by the chief engineer, and these proportions shall be one part sand to one part cement by weight, unless otherwise directed by him. All sand-cement shall be inspected and tested before being used in this work.

7. *Electric Power Plant.*—The United States will build and operate a 2000-H.P. hydro-electric power plant at the Boise River Diversion Dam, about 14 miles west of Arrowrock, together with the necessary transmission lines for furnishing power for construction purposes at the dam site. So far as may be possible and economical, all construction machinery shall be operated by electrical power. This power plant will not be completed and in operation until about June 1, 1912, but electric power purchased in the local market will be available for construction purposes at the dam about October 1, 1911. A fair rate, to be determined by the supervising engineer, for the power used from this plant, shall be charged against the work at the dam, and the power plant will be given a corresponding credit.

8. *Steam Railroad.*—The United States will build and operate a standard gage steam railroad between Arrowrock and Barberton, Idaho, connecting at the latter point with the Barberton branch of the Oregon Short Line Railroad. This road will be in operation by November 15, 1911. Freight rates on this line shall be established from time to time, by the supervising engineer.

9. *Telephone Lines.*—Telephone lines will be built and operated by the United States between Arrowrock and Boise, Idaho, and will be ready for service about May 1, 1911.

10. *Wagon Roads.*—About 25 miles of wagon roads will be built by the United States to replace roads that will be flooded by the Arrowrock Reservoir and for various other purposes. Some of these roads will be of service in hauling lumber and other materials and supplies. The location of these roads is shown in drawing 1.

11. *Construction Camp.*—A construction camp to accommodate about 800 men will be built and maintained at Arrowrock by the United States, and the sanitary conditions at this camp shall be kept at a high degree of excellence at all times.

12. *Sawmill.*—The United States will build and operate a sawmill in the Boise National Forest about 16 miles east of Arrowrock and, as far as may be feasible and economical, all lumber needed in the construction of the dam and its appurtenant features, including the construction camp, shall be manufactured at this mill.

GENERAL FEATURES

13. *Description.*—The work contemplated under these specifications consists of constructing a storage reservoir with a concrete masonry dam and a concrete masonry spillway, together with the incidental work of excavating and constructing diversion works.

The dam will be a gravity type, concrete dam, curved in plan. It will be about 1050 feet long on top and its maximum height will be about 350 feet above the

deepest part of the excavation. The lowest portions of the foundation will be about 80 or 90 feet below the present bed of the river.

The spillway will consist of a concrete weir about 400 feet long, discharging into a channel, to be cut in the hillside. This channel will convey the water around the north end of the dam and will discharge into Deer Creek.

The diversion works will consist of two crib cofferdams across the Boise River and a tunnel about 490 feet long, with a cross-sectional area of about 670 square feet and a capacity of about 20,000 second-feet, having an inlet bell mouth about 90 feet long and an outlet bell mouth about 150 feet long.

EXCAVATION OF TUNNELS

14. *Description of Diversion Tunnel.*—The tunnel will be located in rock for its entire length, and for the greater part will be in firm, hard granite. Pockets of loose lava rock may be encountered but it is expected that such pockets will be of small extent. Where the nature of the rock makes it necessary the sides and roof of the tunnel shall be supported by suitable timbering and lagging. All expense of such timbering shall be classed as timber lining, but the cost of the lagging shall be charged to excavation. As the tunnel is to be lined with concrete on the bottom and sides and with timber above the springing line of the arch, special care shall be exercised to reduce the overbreak to a minimum and to have the exposed rock in good condition, free from cracks and other objectionable defects.

15. *Classification of Material in Diversion Tunnel.*—All material excavated for the diversion tunnel between stations 1+50 and 6+20 and within the limits of the required cross-section as shown in the drawings shall be measured and estimated in cubic yards and classified as follows:

Heading and Arches.—All material above the springing line of the arch.

Bench.—All material below the springing line of the arch.

16. *Shaft.*—A shaft about 6 feet square for use in refilling the tunnel shall be driven as directed by the engineer. As this shaft will also be refilled with concrete, it shall be of the smallest cross-section practicable. The excavation of this shaft shall be measured and estimated by the linear foot.

17. *Cut-off Tunnel.*—A cut-off tunnel shall be driven along the line of contact between the lava and granite and shall later be filled with concrete. This tunnel shall be of the smallest practicable dimensions and the excavation of the same will be measured and estimated by the linear foot.

EXCAVATION FOR DAM, SPILLWAY, TUNNEL PORTALS AND COFFERDAMS

18. *Description.*—The excavation for the dam will cover all excavation required to obtain a suitable foundation for the dam, including excavation for keyways, cut-off trenches, steps or benches, unless such excavation is included under special preparations of rock foundations for dam as outlined in paragraph 46. The material in the river channel consists mainly of river sand, gravel, and boulders, and constitutes the greater part of the material to be excavated for dam foundation. On the south side of the river, the excavation will consist of stripping the dam site of a shallow covering of loose material and cutting suitable foundation in the rock. The work on the north abutment will consist mainly of removing a mass of seamy rock and large boulders embedded in loose rock and loam, and of cutting a suitable foundation in the ledge rock.

The greater part of the material to be excavated for the spillway consists of granite rock, covered by a shallow layer of loam and sand.

The excavation for the tunnel portals will cover all excavation required for the inlet and outlet bell mouths and not included in the tunnel proper. The material consists of a lava rock talus overlying sand, gravel, boulders, and ledge rock.

The excavation for the cofferdams will consist of excavating the river bottom to a level bed and excavating cut-off trenches at the abutments on the north side of the river.

19. *Classification.*—All excavation for the dam, spillway, tunnel portals and cofferdams shall be measured and estimated by the cubic yard under the following classes:

Dry Excavation.—All material excavated above elevation 2960, which is about the mean low water level of the Boise River.

Wet Excavation.—All material excavated below elevation 2960.

The classifications of material shall be the same under each of the above designations and shall be as follows:

Loose Material.—The excavation of loose material shall include the excavation and disposal of all loam, sand, gravel, mud, loose rock, and all other material not included in rock excavation, except as hereinafter specified under Paragraph 46.

Rock Excavation.—Rock excavation shall include the excavation and disposal of all solid rock removed by blasting, boulders of one-half a cubic yard or more in volume, and all rock removed by barring and wedging. Wherever the excavation consists of a large proportion of boulders of one-half a cubic yard or more in volume occurring in gravel, earth, or loose rock, as is the case near the river level on the north side of the river channel, the amount of "rock excavation" may be estimated as a percentage of the total excavation if deemed advisable by the engineer.

20. *Rock Excavation for Foundations.*—Rock shall be excavated to a sufficient depth to secure a foundation on sound ledge rock, free from open seams or other objectionable defects. It is the intention to build the masonry against the sides of these rock excavations. To preserve the rock outside the lines of the excavation in the soundest possible condition and to obtain over the whole foundation a rock surface free from open seams or cracks, unusual precautions shall be used in excavating. Rock excavation may be done by blasting to the extent directed by the engineer, with explosives of such moderate power and in such positions as will neither crack nor damage the rock outside of the prescribed limits of the excavation; and whenever, in the opinion of the engineer, further blasting is liable to injure the rock upon or against which the masonry is to be built, blasting shall be discontinued and the excavation of the rock continued by wedging and barring, or other approved methods.

21. *Preparation of Rock Foundations.*—The surfaces of the rock foundations shall be left sufficiently rough to bond well with the masonry and, if required by the engineer, shall be cut into rough benches or steps, and great care shall be taken not to open or break the ledge rock unnecessarily in doing this work. Before laying the masonry on or against the ledge rock, the latter shall be scrupulously freed from all dirt, gravel, scale, loose fragments, and other objectionable substances by means of jets of water, air, or steam under effective pressure, or of stiff brooms

hammers and other effective tools. Steam jets shall be used to remove thoroughly any ice or snow that may be on the ledge rock when it is desired to lay masonry. All springs shall be piped and grouted in a satisfactory manner. After cleaning and before concrete is laid on or against the ledge rock the water shall be removed from the depressions so that the surface can be inspected to determine whether seams or other defects exist. All expense of preparing rock foundations except as hereinafter stated in paragraphs 44, 45, and 46 shall be included in the cost of "rock excavation."

GENERAL REQUIREMENTS FOR CONCRETE

22. *Composition.*—All concrete shall be composed of cement, sand, gravel and water, or cement, sand, gravel, water and cobblestones, in the proportions fixed by the construction engineer for the character or work in hand. The cement used will in general be sand cement, but in the diversion works and in other special cases when directed by the engineer. Portland cement may be used.

23. *Sand.*—The sand used in concrete shall be of a quality satisfactory to the construction engineer, shall be free from organic matter, and shall not contain more than 10 per cent by weight of clay or other foreign matter. The particles of sand shall be well graded, and the coarsest particles shall not be larger than those that will pass a screen having $\frac{3}{8}$ -inch square holes. The sand shall be of the best quality obtainable at reasonable cost in the vicinity of the work.

24. *Gravel.*—The gravel used in the concrete shall be either clean, hard, broken rock, or clean, screened gravel and shall be well graded and of such sizes as will pass a grizzly having bars set 3 inches apart and will be retained on a screen having $\frac{3}{8}$ -inch square holes.

25. *Cobblestones.*—Cobblestones used in the concrete shall be sound, clean gravel or broken rock of such size as will pass a grizzly having bars set about 6 inches apart and be retained on a grizzly having bars set 3 inches apart.

26. *Water.*—The water used for the concrete shall be reasonably clean and free from objectionable quantities of organic matter, oil, grease, or other like impurities.

27. *Mixing.*—The sand, gravel, cobbles, and cement shall be mixed and the quantity of water added shall be such as to produce a homogeneous mass of uniform consistency. Except in cases of emergency when small quantities are needed, the concrete shall be mixed by one of the standard "batch" machine mixers. Whenever any machine fails to perform the mixing thoroughly, it shall be made satisfactory or removed and another machine substituted. When from any cause resort to hand mixing is necessary, the mixing shall be done in a thorough and satisfactory manner. Concrete shall be mixed "wet" wherever practicable and "dry" only when the nature of the work renders such use unavoidable.

28. *Placing.*—The concrete shall be handled in such a manner that initial set or the separation of the ingredients before depositing shall be avoided. Should separation occur, the concrete shall be thoroughly remixed. No concrete that has received its initial set before being deposited shall be used in the work and any such mixture shall be immediately removed from the vicinity of the work. All surfaces upon which concrete is laid shall be cleaned as specified or directed and thoroughly wet immediately before concrete is deposited. If so directed, a bed of fresh mortar of the thickness required or a thin coat of grout shall be spread

over the foundation and thoroughly worked into all depressions and crevices. Under no circumstances shall concrete be laid in deep, moving, or muddy water. All exposed faces of concrete work shall be moulded against steel forms, or, if timber forms are used, against lagging that has been sized to uniform thickness and placed so as to prevent leakage of the fluid concrete. All forms shall be accurately and rigidly placed to conform to the lines established by the engineer. The bracing and tying devices must have sufficient strength and stiffness to withstand the pressure of fluid concrete without springing or warping. The concrete shall be placed against these forms and so manipulated by spading and tamping as to secure a body of concrete having the maximum possible density and showing smooth and uniform faces. Where the use of contraction joints is specified for the separation of adjoining masses, the expense of constructing all such joints shall be included in the cost of placing concrete.

29. *Building New Concrete on Old.*—In order to insure a thorough bonding and a perfect joint between fresh concrete and that which has set, such provision shall be made of steps, dovetails or other devices or methods as may be prescribed. Whenever fresh concrete and concrete that has set are joined, the contact surfaces of the old concrete shall be thoroughly roughened and cleaned, and it shall be clean and wet, but free from pools of water, at the moment the fresh concrete is placed. If directed, a bed of fresh mortar or a coat of grout shall be applied to the contact surfaces of the old concrete and thoroughly worked into all depressions and crevices. Special efforts shall be made to remove very thoroughly all laitance and other substances which would prevent complete cohesion of the concrete throughout the main body of the dam.

30. *Laying Concrete in Freezing Weather.*—No concrete shall be laid during freezing weather unless special precautions are taken to prevent damage from freezing. Whenever concrete is laid during freezing weather, the materials of the aggregate shall be thoroughly heated to remove all frost and warm water shall be used in mixing. No frozen materials shall be used in making concrete and no concrete shall be allowed to freeze in any part within ten days after mixing nor shall any concrete be built upon a frozen surface.

31. *Embedded Rock.*—In all mass concrete having a thickness of 15 inches or more, sound and clean cobblestones or rock fragments of a size that can be lifted and handled by one man, shall be incorporated in the concrete. The proportion of such rocks shall be as nearly uniform throughout as practicable. No rock shall be laid in actual contact with an adjacent one or within 2 inches of the forms. In the main body of the dam, there shall be placed hard, sound, clean, and durable rocks of derrick size, carefully shaken to position in fresh beds of concrete. Whenever possible, smaller rocks shall be embedded in the concrete between the large rocks. The object is to obtain, especially in the main body of the dam, a monolithic mass of stone and concrete containing as large a proportion of rock and as impervious to water as it is practicable to secure. Stones to be used as embedded rock wherever used shall be thoroughly cleaned before being brought to the place where they are to be used, by washing with water under pressure from a nozzle, by the use of brushes, or as otherwise directed, and shall be satisfactorily clean when placed in the concrete. All rock shall be thoroughly wet at the time of placing in the work.

32. *Sprinkling.*—During all of the year except the colder months, all concrete

shall be kept thoroughly wet by sprinkling with water until the concrete shall have become thoroughly set.

33. *Finishing Concrete Surfaces.*—Immediately after the removal of the forms, all rough surfaces and irregularities of exposed work shall be dressed and all voids that may occur shall be filled with mortar. The floors of the spillway and diversion tunnel shall have their top surface finished by straight-edging and floating similar to a sidewalk finish, except that the standard mixture of concrete shall be used without any additional surface coat of mortar. Such surfacing shall be done immediately after placing the body of the concrete. A wash of thin cement grout shall be applied to all exposed surfaces of concrete except floors and similar surfaces. The outlet conduits shall be finished smooth and particular care shall be taken by hand troweling or otherwise, to make a hard, smooth, surface.

CONCRETE FOR SPILLWAY

34. *Description.*—The concrete work in the spillway will consist of constructing of mass concrete the spillway weir, which will be about 400 feet long, and of lining the sides and bottom of the spillway trench with reinforced concrete and of constructing the roadway and parapet walls below the end of the dam.

35. *Classification.*—All concrete placed in the spillway weir shall be classed and estimated as "spillway weir." All other concrete placed in the spillway structure shall be classed and estimated as "spillway lining."

36. *Special Foundation of Broken Stone.*—The foundation for certain portions of the concrete used in the spillway lining shall be a layer of broken stone, not less than 4 inches thick at any point, thoroughly rammed. The top of this layer of rock shall be at the bottom of the concrete lining as shown in the drawings. This special foundation shall be measured and estimated in cubic yards on a basis of a 6-inch thickness, unless a greater depth of broken stone is required by the engineer, in which case the additional rock required shall be measured and estimated. Details of this work are shown and described further in drawing 5.

CONCRETE FOR DIVERSION TUNNEL

37. *Description.*—The bottom lining of the tunnel will consist of plain concrete and the side lining will consist of plain concrete suitably bonded to the rock sides where necessary by means of steel bars. The inlet and outlet wing walls will consist of concrete lining placed on the rock sides and suitably bonded thereto, and, in most cases, surmounted by a concrete wall of gravity section. The inlet and outlet floors will consist of a lining of plain concrete where the foundation is ledge rock and of reinforced concrete where the foundation is sand and gravel. The tunnel refilling will consist of placing mass concrete in the portion of the tunnel underlying the foundations of the dam. All expense incurred in such refilling, including cofferdams, and bulkheads, shall be charged to this item.

38. *Classification.*—All concrete placed as lining between stations 1+50 and 6+20 of the diversion tunnel shall be classed and estimated as "diversion tunnel lining." All concrete placed in inlet and outlet walls and portals and not included as tunnel lining shall be classed and estimated as "diversion tunnel inlet and outlet wing walls." All concrete placed in the floors and cut-off walls of the inlet and outlet and not included in tunnel lining shall be classed and estimated as

"diversion tunnel inlet and outlet floors." All concrete placed in refilling the tunnel shall be classed and estimated as "refilling diversion tunnel."

39. *Refilling Shaft.*—The shaft shall be refilled with concrete as directed by the engineer. This refilling shall consist of mass concrete and shall be measured and estimated by the cubic yard.

CONCRETE FOR COFFERDAMS

40. *Classification and Description.*—All concrete placed in the cofferdams shall be classed and estimated as "cofferdam concrete." This item consists mainly of plain concrete to be placed in the core walls of the abutment.

CONCRETE FOR CUT-OFF TUNNEL

41. *Classification and Description.*—All concrete placed in refilling the cut-off tunnel shall be classed and estimated as "refilling of cut-off tunnel."

CONCRETE FOR DAM

42. *Description.*—It is planned to build the main body of the dam of concrete consisting of about 1 part sand-cement, 2½ parts sand, 5 parts gravel and 3 or 4 parts cobblestones, in which large rock and boulders of various sizes will be embedded. These proportions may be varied to suit conditions as they may develop. A small amount of reinforced concrete will also be used.

43. *Classification and Measurement.*—All concrete in the dam shall be classed and estimated under one item. Deductions shall be made from the gross volume for the space occupied by the inspection tunnel and the outlets, but no deductions shall be made on account of the drainage system.

SPECIAL PREPARATION OF ROCK FOUNDATION OF DAM

44. *Description.*—After the rock foundation for the dam has been prepared as outlined in paragraph 21 of these specifications, all further work on said foundation whether shown in the drawings or required by the engineer, shall be designated as "special preparation of rock foundation of dam," provided such further work is not included under paragraph 28 of these specifications.

45. *Classification.*—Special preparation of rock foundations of dam shall be measured and estimated under the following classes:

Areas Receiving Special Preparation.—All areas receiving special preparation as outlined in paragraph 46 shall be measured and estimated by the square yard and at least 5 square yards shall be allowed for any area on which such special preparation is required.

Pressure Grouting.—All pressure grouting as outlined in paragraph 47 shall be measured and estimated by the barrel of cement used in such grouting.

Drilling Drainage Holes and Main Grout Holes.—All drilling for drainage holes and for the main grout holes shown on the drawings and not included under paragraph 46 shall be measured and estimated by the linear foot of holes drilled.

46. *Areas Receiving Special Preparation.*—Portions or the whole of the foundations of the dam may be designated for special preparation and in all areas thus designated seams and cavities shall be traced as far as directed by the engineer by drilling holes or by other approved means. All such seams and cavities shall then be filled with concrete, mortar, or grout. Whenever directed by the engineer,

grout shall be pumped under pressures required by him through hose or pipe of at least 2 inches in diameter, and the connection between the hose or pipe and the rock shall be made tight. Such grouting does not include grouting the main grout holes shown in the drawings and described under paragraph 47.

47. *Pressure Grouting and Drilling Drainage Holes and Main Grout Holes.*—In addition to the drilling and pressure grouting that may be required under paragraph 46, deep grout and drainage holes shall be drilled as shown on the drawings or as directed by the engineer, and after a portion of the masonry in the dam has been placed, grout under suitable pressure shall be pumped into the grout holes as directed by the engineer.

STRUCTURAL TIMBER

48. *Description.*—Structural timber will be required for the upper and lower cofferdams, for portions of the diversion tunnel inlet and outlet wing walls, and for the timber lining for the roof of the diversion tunnel. All structural timber shall be of the dimensions shown in the drawings, free from loose knots, shakes, or other imperfections that impair its strength for the uses for which it is intended. Unless otherwise specified or required, all structural timber shall be of pine or fir obtained near the sawmill mentioned in paragraph 12.

49. *Measurement.*—All structural timber shall be measured by the thousand feet board measure in place.

COFFERDAMS AND TIMBER WING WALLS

50. *Description.*—The upper and lower cofferdams and the timber of the diversion tunnel wing walls will consist of timber cribs of the dimensions shown on the drawings, thoroughly filled with loam, sand, gravel and rock as specified in paragraph 53. Longitudinal timbers shall break joints and shall butt only at intersections with cross timbers. At butting joints, two drift bolts shall be placed in the end of each butting timber and at all other intersections the timbers shall be secured by two drift bolts.

TIMBER LINING IN DIVERSION TUNNEL

51. *Description.*—The timber lining in the diversion tunnel will consist of 4×12-inch planks securely spiked to 14×14-inch timber sets as shown on the drawings. The 4×12-inch planks shall be of Oregon fir or other suitable material, carefully dressed to the required thickness. These planks shall break joints and butt only at intersections with the timber sets. At butting joints three 10-inch boat spikes shall be placed in the end of each abutting plank, and at all other intersections the planks shall be secured by three 10-inch boat spikes. The space between the timber sets and the excavated section shall be thoroughly filled with blocking and lagging as directed by the engineer. All cost of such blocking and lagging, not provided for in paragraph 14, shall be charged to the cost of timber lining.

PILING

52. *Description and Measurement.*—Round piles and sheet piles of the dimensions shown in the drawings will be required in the construction of the cofferdams. Round piles shall be measured as the number of such piles actually placed in the cofferdams. Round piles shall be of lengths shown on the drawings and shall

be cut from sound, growing timber of either pine or fir, straight and tapering, and not less in diameter than 8 inches at the smaller end. Sheet piles shall be made of sound fir or pine timbers of the size and lengths required with strips of 3×4-inch timber securely spiked on two opposite sides in such a manner as to form a tongue and groove on each pile. Sheet piles shall be measured and estimated under two heads, "number of piles driven" and "feet board measure." The "number of piles driven" shall include only the number of piles actually driven and left in the cofferdams. "Feet board measure" shall include only such piles as are driven and left in the cofferdams but shall include the waste by cut-off from such piles.

ROCK FILL

53. *Description and Measurement.*—Rock fill will be required in the cofferdams and in the crib portions of the tunnel wing walls. It shall consist of rock fragments of varying size, sand, gravel and loam in proportions fixed by the engineer, the whole mass being classed as rock fill. The manner of placing rock fill shall be subject to the approval of the construction engineer and will vary in different parts of the work, but wherever practicable the voids in the rock fill shall be filled with the fine material by hydraulicizing this material compactly in place. Rock fill will be measured in place and estimated by the cubic yard.

RIPRAP

54. *Classification.*—Riprap will be classed as follows:

Grouted Riprap.—All riprap grouted with cement grout or with concrete.

Plain Riprap.—All riprap not included in grouted riprap.

55. *Description.*—Riprap will consist of rock of good, hard durable quality, not less than 12 inches in thickness, placed upon a bed of gravel or broken stone not less than 9 inches in thickness. The riprap shall be laid by hand and the base of each stone shall be bedded in the foundation with its top conforming to the surface required. All spaces between the stones shall be filled by smaller stones and gravel. The thickness of the riprap shall be as required by the engineer, and the thickness of the foundation shall be not less than two-thirds the required thickness of the rock. If grouting is required the grout shall be composed of 1 part cement and 3 parts sand, or of concrete in about the proportions of 1 part cement, 3 parts sand and 6 parts gravel or broken stone, which shall be well worked in between the rocks after the latter are laid.

DRAINAGE

56. *Description and Classification.*—When indicated in the drawings or directed by the engineer, drainage conduits shall be placed to lines and grades as required, and due precautions shall be taken to maintain the same in perfect condition until the completion of the work. Drains shall be measured and estimated by the linear foot.

PLACING METAL WORK

57. *Description.*—The gates, frames and appurtenances, steel for concrete reinforcement, the cast-iron lining for the outlet conduits, and all other metal work, shall be set as shown in the drawings or as required by the engineer. Anchor bolts

shall be properly built into the concrete, all gates, frames, screens and operating devices shall be set in correct position at the proper time, the rising stems shall be properly alined, and the whole finally left in good working order. Embedded surfaces shall have all dirt or other objectionable material removed before being placed in the concrete. Such steel bars for concrete reinforcement as are required by the drawings or by direction of the engineer shall be accurately placed and perfect contact shall be secured between the bars and the mortar of the surrounding concrete. Bars shall be tightly wired together at all points of intersection and so secured in position that they will not be disturbed during the placing of the concrete. All of the above-mentioned metal work, except steel for concrete reinforcement, shall be purchased through the chief electrical engineer.

58. *Measurement.*—Placing metal work shall be measured and estimated as the number of pounds of metal work in place.

59. *Painting.*—All exposed metal work after erection shall be thoroughly cleaned and finished with two coats of paint. The paint shall be of good quality graphite, or other material, as selected by the engineer. The cost of painting shall be included in the cost of placing metal work.

OUTLET CONDUITS

60. *Description and Measurement.*—The dam will contain 25 or more outlet conduits having a diameter of 5 feet throughout the greater part of their length. The outlet conduits will be measured and estimated by the linear foot, the length of a given conduit being considered as the length measured on the center line of that conduit. All cost of constructing the outlet conduits shall be charged to "outlet conduits" except the cost of setting the cast iron linings, anchor bolts, etc., which will be charged to "placing metal work."

INSPECTION GALLERY

61. *Description and Measurement.*—An inspection gallery of varying size and elevation shall be constructed in the body of the dam as shown in the drawings or as directed by the chief engineer.

The inspection gallery shall be measured and estimated by the linear foot, the length being considered as the actual length of the center line of the gallery measured along planes parallel to the general bottom surface of the gallery.

LOG HOIST

62. *Description and Classification.*—When log driving in the Boise River is resumed and it becomes necessary for log drives to pass the dam, suitable means shall be provided for hoisting the logs from the reservoir and transporting them to the river below the dam. All expense incurred in connection with such hoisting and transportation shall be considered a single item and classed as "log hoist and chute."

CONTRACT SPECIFICATIONS

GENERAL REQUIREMENTS

1. *Form of Proposal and Signature.*—The proposal shall be made on the form provided therefor and shall be enclosed in a sealed envelope marked and addressed as required in the notice to bidders. The bidder shall state in words and figures the unit prices or the specific sums, as the case may be, for which he proposes to supply the material or machinery and perform the work required by these specifications. If the proposal is made by an individual it shall be signed with his full name, and his address shall be given; if it is made by a firm it shall be signed with the copartnership name by a member of the firm, who shall also sign his own name, and the name and address of each member shall be given; and if it is made by a corporation it shall be signed by an officer with the corporate name attested by the corporate seal, and the names and titles of all officers of the corporation shall be given.

2. *Proposal.*—Blank spaces in the proposal should be properly filled. The phraseology of the proposal must not be changed, and no additions should be made to the items mentioned therein. Unauthorized conditions, limitations or provisos attached to a proposal will render it informal and may cause its rejection. Alterations by erasure or interlineation must be explained or noted in the proposal over the signature of the bidder. If the unit price and the total amount named by a bidder for any item do not agree, the unit price alone will be considered as representing the bidder's intention. A bidder may withdraw his proposal before the expiration of the time during which proposals may be submitted, without prejudice to himself, by submitting a written request for its withdrawal to the officer who holds it. No proposals received after said time or at any place other than the place of opening as stated in the advertisement will be considered. Bidders, their representatives, and others interested, are invited to be present at the opening of proposals. The right is reserved to reject any or all proposals, to accept one part of a proposal and reject the other, and to waive technical defects.

3. *Certified Check.*—Each bidder shall submit with his proposal an unconditional certified check for the sum stated in the notice to bidders, payable to the order of..... Any condition or limitation placed upon a certified check will render it informal and may result in the rejection of the proposal under which such check is submitted. If the bidder to whom an award is made fails or refuses to execute the required contract and bond within the time specified in paragraph 4, or such additional time as may be allowed by the engineer, the proceeds of his check shall become subject to forfeit, and the proceeds of said check are hereby agreed upon as liquidated damages on account of the delay in the execution of the contract and bond and the performance of work thereunder, and the necessity of accepting a higher or less desirable bid resulting from such failure or refusal to execute contract and bond as required. The proceeds of the check of the successful bidder will be returned after the execution of his contract and the approval of his bond, and the proceeds of the checks of the other bidders will be returned at the expiration of forty-five days from the date of opening proposals, or sooner if contract is executed prior to that time.

4. *The Contract.*—The bidder to whom award is made shall execute a written contract with and, if bond is required, furnish good and approved bond within fifteen days after receiving the forms of contract and bond for execution. If the bidder to whom award is made fails to enter into contract as herein provided, the award will be annulled, and an award may be made to the bidder whose proposal is next most acceptable in the opinion of the officer by whom the first award was made; and such bidder shall fulfill every stipulation embraced herein as if he were the party to whom the first award was made. The advertisement, notice to bidders, proposal, general conditions, and detail specifications will be incorporated in the contract. A corporation to which an award is made will be required, before the contract is finally executed, to furnish evidence of its corporate existence and evidence that the officer signing the contract and bond for the corporation is duly authorized to so do.

5. *Contractor's Bond.*—Unless another sum is specified in the notice to bidders, the contractor shall furnish bond in an amount not less than 20 per cent of the estimated aggregate payments to be made under the contract, conditioned upon the faithful performance by the contractor of all covenants and stipulations in the contract. Bonds in amounts less than \$5000 will be made only in multiples of \$100; in amounts exceeding \$5000 in multiples of \$1000; provided that the amount of the bond shall be fixed at the lowest sum that will fulfill all conditions herein set forth. If during the continuance of the contract any of the sureties die or become irresponsible, may require additional sufficient sureties, which the contractor shall furnish to the satisfaction of that officer within ten days after notice, and in default thereof the contract may be suspended by and the materials purchased or the work completed as provided in paragraph 10.

6. *Engineer.*—The word "engineer" used in these specifications or in the contract means the Chief Engineer of He will be represented by assistants and inspectors, authorized to act for him. On all questions concerning the acceptability of material or machinery, the classification of material, the execution of the work, conflicting interests of contractors performing related work; and the determination of costs, the decision of the Chief Engineer shall be final, and binding upon both parties.

7. *Contractor.*—The word "contractor" used in these specifications or in the contract means the person, firm, or corporation with whom the contract is made. The contractor shall at all times be represented on the works in person or by a foreman or duly designated agent. Instructions and information given by the engineer to the contractor's foreman or agent on the work shall be considered as having been given to the contractor. When two or more contractors are engaged on installation or construction work in the same vicinity the engineer shall be authorized to direct the manner in which each shall conduct his work so far as its affects other contractors.

8. *Material and Workmanship.*—The contractor shall submit samples or specimens of such materials to be furnished or used in the work as the engineer may require. All materials must be of the specified quality and equal to approved samples if samples have been submitted. All work shall be done and completed in a thorough, workmanlike manner. Work, material, or machinery not in accordance with these specifications, in the opinion of the engineer, shall be

made to conform thereto. Unsatisfactory material will be rejected, and, if so ordered by the engineer, shall, at the contractor's expense, be immediately removed from the vicinity of the work.

9. *Delays.*—If any delay is caused the contractor by specific orders of the engineer to stop work, or by the performance of extra work ordered by the engineer, or by the failure of to provide material, or necessary instructions for carrying on the work, or to provide the necessary right of way, or site for installation, or by unforeseen causes beyond the control of the contractor, such delay will entitle the contractor to an equivalent extension of time, except as otherwise provided in paragraph 27. Application for extension of time must be approved by the engineer and shall be accompanied by the formal consent of the sureties, but an extension of time, whether with or without such consent, shall not release the sureties from their obligations, which shall remain in full force until the discharge of the contract. If delays from any of the above-mentioned causes occur after the expiration of the contract period no liquidated damages shall accrue for a period equivalent to such delay.

10. *Suspension of Contract.*—If the contractor fails to begin the delivery of the material or to commence work as provided in the contract, or fails to make delivery of material promptly as ordered, or to maintain the rate of delivery of material or progress of the work in such a manner as in the opinion of the engineer will insure a full compliance with the contract within the time limit, or if in the opinion of the engineer the contractor is not carrying out the provisions of the contract in their true intent and meaning, written notice will be served on him to provide within a specified time for a satisfactory compliance with the contract, and if he neglects or refuses to comply with such notice the engineer may suspend the operation of all or any part of the contract, or he may in his discretion after such notice perform any part of the work or purchase any or all of the material included in the contract or required for the completion thereof without suspending the contract. Upon suspension of contract, the engineer may in his discretion take possession of all or any part of the machinery, tools, appliances, animals, materials, and supplies used on the work covered by the contract or that have been delivered by or on account of the contractor for use in connection therewith, and the same may be used either directly by or by other parties for it, in the completion of the work suspended; or may employ other parties to perform the work, or may substitute other machinery or materials, purchase the material contracted for in such manner as it may deem proper, or hire such force and buy such machinery, tools, appliances, animals, materials, and supplies at the contractor's expense as may be necessary for the proper conduct and completion of the work. Any cost to in excess of the contract price, arising from the suspension of the contract, or from work performed or purchases made by either before or after suspension, and required on account of failure of the contractor to comply with his contract or the orders of the engineer issued in pursuance thereof, will be charged to the contractor and his sureties, who shall be liable therefor. A special lien to secure the claims of in the event of suspension of the contract is hereby created against any property of the contractor taken into the possession of under the terms hereof, and such lien may be enforced by a sale of such property, and the proceeds of the sale, after deducting all expenses thereof and connected

therewith, shall be credited to the contractor. If the net credits shall be in excess of the claims of against the contractor the balance will be paid to the contractor or his legal representatives. In the determination of the question whether there has been such noncompliance with the contract as to warrant its suspension or the furnishing of material or the performance of work by as herein provided, the decision of the engineer shall be final and binding upon both parties. Suspension of the contract, or any part thereof, shall operate only to terminate the right of the contract or to proceed with the work covered by the contract or the suspended portions thereof. The provisions of the contract permitting to make changes and to make proper adjustment of accounts to cover any increase or decrease of cost on account of such changes, and all other stipulations of the contract except those giving the contractor the right to proceed with work on the items covered by the suspension, shall be and remain in full force and effect after such suspension and until the contract shall have been completed and final payment or final adjustment of accounts made.

11. *Changes.*—The engineer may, without notice to the sureties on the contractor's bond, make changes: (a) in the designs or materials of machinery; (b) in the plans for installation or construction; (c) in the quantities or character of the work or material required. The changes in plans for installation or construction may also include: (a) modifications of shapes and dimensions of canals, dams, and other structures; (b) the shifting of locations to suit conditions disclosed as work progresses. If such changes result in an increase of cost to the contractor, the engineer will make such additions on account thereof as he may deem reasonable and proper, and his action thereon shall be final. Extra work or material shall be charged for as hereinafter provided.

12. *Extra Work or Material.*—In connection with the work covered by this contract, the engineer may at any time during the progress of the work order work or material not covered by the specifications. Such work or material will be classed as extra work and will be ordered in writing. No extra work or material will be paid for unless ordered in writing. Extra work or material shall be charged for at actual necessary cost, as determined by the engineer, plus 15 per cent for profit, superintendence, and general expenses. The actual necessary cost will include all expenditures for materials, labor, and supplies furnished by the contractor, but will in no case include any allowance for office expenses, general superintendence, or other general expenses. At the end of each month the contractor shall present in writing any claims for extra work performed during that month and extra material delivered during that month and, when requested by the engineer, shall furnish itemized statements of the cost and shall permit examination of accounts, bills, and vouchers relating thereto. No such claim will be allowed which is not presented to the engineer in writing within thirty days after the close of the month, during which the extra work or material covered by such claim is alleged to have been furnished, and any such claim not so presented will be deemed to have been waived by the contractor.

13. *Delays—No Extra Compensation.*—The contractor shall receive no compensation for delays or hindrances to the work except when, in the judgment of the engineer, direct and unavoidable extra cost to the contractor is caused by the failure of to provide necessary information, material, right of way, or site for installation. When such extra compensation is claimed a written

itemized statement setting forth in detail the amount thereof shall be presented by the contractor not later than sixty days after the close of the month during which extra cost is claimed to have been incurred. Unless so presented the claim shall be deemed to have been waived. Any such claim, if found correct, will be approved and the amount found due as actual extra cost will be covered by the next estimate thereafter paid under the contract. The decision of the engineer whether extra cost has been incurred and the amount thereof shall be final.

14. *Changes at Contractor's Request.*—If the contractor, on account of conditions developing during the progress of the work, finds it impracticable to comply strictly with these specifications and applies in writing for a modification of requirements or of methods of work, such change may be authorized by the engineer if not detrimental to the work and if without additional cost to

15. *Inspection.*—All materials furnished and work done under this contract will be subject to rigid inspection. The contractor shall furnish without extra charge complete facilities, including the necessary labor for the inspection of all material and workmanship. The engineer, or his authorized agent, shall have at all times access to all parts of the shop where such material under his inspection is being manufactured. Work or material that does not conform to the specifications, although accepted through oversight or otherwise, may be rejected at any stage of the work. Whenever the contractor on installation or construction is permitted or directed to do night work or to vary the period during which work is carried on each day, he shall give the engineer due notice, so that inspection may be provided. Such work shall be done without extra compensation and under regulations to be furnished in writing by the engineer.

16. *Contractor's Financial Obligations.*—The contractor shall promptly make payments to all persons supplying labor and materials in the execution of the contract, and a condition to this effect shall be incorporated in the contractor's bond.

17. *Experience.*—Bidders, if required, shall present satisfactory evidence that they have been regularly engaged in furnishing such material and machinery and constructing such work as they propose to furnish or construct and that they are fully prepared with necessary capital, machinery, and material to begin the work promptly and to conduct it as required by these specifications.

18. *Specifications and Drawings.*—The contractor shall keep on the work a copy of the specifications and drawings and shall at all times give the engineer access thereto. Any drawings or plans listed in the detail specifications shall be regarded as part thereof and of the contract. Anything mentioned in these specifications and not shown on the drawings or shown on the drawings and not mentioned in these specifications shall be of like effect as though shown or mentioned in both. The engineer will furnish from time to time such detail drawings, plans, profiles, and information as he may consider necessary for the contractor's guidance, unless otherwise provided in the proposal, agreement, or detail specifications.

19. *Local Conditions.*—Bidders shall satisfy themselves as to local conditions affecting the work, and no information derived from the maps, plans, specifications, profiles, or drawings, or from the engineer or his assistants, will relieve the contractor from any risk or from fulfilling all of the terms of his contract. The

accuracy of the interpretation of the facts disclosed by borings or other preliminary investigations is not guaranteed. Each bidder or his representative should visit the site of the work and familiarize himself with local conditions; failure to do so when intelligent preparation of bids depends on a knowledge of local conditions may be considered sufficient cause for rejecting a proposal.

20. *Data to be Furnished by the Contractor.*—The contractor shall furnish the engineer reasonable facilities for obtaining such information as he may desire respecting the character of the materials and the progress and manner of the work, including all information necessary to determine its cost, such as the number of men employed, their pay, the time during which they worked on the various classes of construction, etc. The contractor shall also furnish the engineer copies of freight bills on all machinery, materials, and supplies shipped to or from the project in connection with the work under the contract.

21. *Restrictions on Disposition of Plant, etc.*—The contractor shall not make any disposition of the plant, machinery, tools, appliances, supplies, materials, or animals used on or in connection with the work, either by sale, conveyance, or incumbrance, inconsistent with the special lien created by this contract.

22. *Damages.*—The contractor will be held responsible for and required to make good, at his own expense, all damage to person or property caused by carelessness or neglect on the part of the contractor, or subcontractor, or the agents or employees of either.

23. *Character of Workmen.*—The contractor shall not allow his agents or employees, his subcontractors, or any agent or employee thereof, to trespass on premises or lands in the vicinity of the work. None but skilled foremen and workmen shall be employed on work requiring special qualifications, and when required by the engineer the contractor shall discharge any person who commits trespass or is in the opinion of the engineer disorderly, dangerous, insubordinate, incompetent, or otherwise objectionable. Such discharge shall not be the basis of any claim for compensation or damages.

24. *Methods and Appliances.*—The methods and appliances adopted by the contractor shall be such as will, in the opinion of the engineer, secure a satisfactory quality of work and will enable the contractor to complete the work in the time agreed upon. If at any time the methods and appliances appear inadequate, the engineer may order the contractor to improve their character or efficiency, and the contractor shall conform to such order; but failure of the engineer to order such improvement of methods or efficiency will not relieve the contractor from his obligation to perform satisfactory work and to finish it in the time agreed upon.

25. *Climatic Conditions.*—The engineer may order the contractor to suspend any work that may be subject to damage by climatic conditions. When delay is caused by an order to suspend work given on account of climatic conditions that could have been reasonably foreseen the contractor will not be entitled to any extension of time on account of such order.

26. *Quantities and Unit Prices.*—The quantities noted in the schedule or proposal are approximations for comparing bids, and no claim shall be made for excess or deficiency therein, actual or relative. Payment at the prices agreed upon will be in full for the completed work and will cover materials, supplies, labor, tools, machinery, and all other expenditures incident to satisfactory compliance with the contract, unless otherwise specifically provided.

27. *Removal and Rebuilding of Defective Work.*—The contractor shall remove and rebuild at his own expense any part of the work that has been improperly executed, even though it has been included in the monthly estimates. If he refuses or neglects to replace such defective work, it may be replaced at the expense of the contractor, and his sureties shall be liable therefor.

28. *Protection of Work and Cleaning Up.*—The contractor shall be responsible for any material furnished him and for the care of all work until its completion and final acceptance, and he shall at his own expense replace damaged or lost material and repair damaged parts of the work, or the same may be done at his expense, and his sureties shall be liable therefor. He shall take all risks from floods and casualties and shall make no charge for detention from such causes. He may, however, be allowed a reasonable extension of time on account of such detention, subject to the conditions hereinbefore specified. The contractor shall remove from the vicinity of the completed work all plant, buildings, rubbish, unused material, concrete forms, etc., belonging to him or used under his direction during construction, and in the event of his failure to do so the same may be removed at the expense of the contractor, and his sureties shall be liable therefor.

29. *Roads and Fences.*—Roads subject to interference from the work covered by this contract shall be kept open, and the fences subject to interference shall be kept up by the contractor until the work is finished.

30. *Bench Marks and Survey Stakes.*—Bench marks and survey stakes shall be established by the engineer and shall be preserved by the contractor, and in case of their destruction or removal by him or his employees, they will be replaced by the engineer at the contractor's expense, and his sureties shall be liable therefor.

31. *Right of Way.*—The site for the installation of machinery or the right of way for the works to be constructed under this contract and for necessary borrow pits, channels, spoil banks, ditches, roads, etc., will be provided by

32. *Sanitation.*—The engineer may establish sanitary and police rules and regulations for all forces employed under this contract, and if the contractor fails to enforce these rules the engineer may enforce them at the expense of the contractor. The use or sale of intoxicating liquor is absolutely prohibited on the work, except for medicinal purposes, and every such use or sale shall be under the direction and supervision of the engineer.

33. *Infringement of Patents.*—The contractor shall hold and save and his officers, agents, servants, and employees harmless from and against all and every demand, or demands, of any nature or kind, for or on account of the use of any patented invention, article, or appliance included in the material or supplies hereby agreed to be furnished under this contract, and should the contractor, his agents, servants, or employees, or any of them, be enjoined from furnishing or using any invention, article, material, or appliance supplied or required to be supplied or used under this contract, the contractor shall promptly substitute other articles, materials, or appliances in lieu thereof, of equal efficiency, quality, finish, suitability, and market value, and satisfactory in all respects to the engineer. Or, in the event that the engineer elects, in lieu of such substitution, to have supplied, and to retain and use, any such invention, article, material, or appliance, as may by this contract be required to be supplied, in that event the contractor shall pay such royalties and secure such valid licenses as may be requisite and necessary to enable his officers, agents, servants, and employees, or

any of them, to use such invention, article, material, or appliance without being disturbed or in any way interfered with by any proceeding in law or equity on account thereof. Should the contractor neglect or refuse promptly to make the substitution hereinbefore required, or to pay such royalties and secure such licenses as may be necessary and requisite for the purpose aforesaid, then in that event the engineer shall have the right to make substitution, or may pay such royalties and secure such licenses, and charge the cost thereof against any money due the contractor from or recover the amount thereof from him and his surety, notwithstanding final payment under this contract may have been made. The provisions of this paragraph do not apply to articles which the contractor is required to manufacture or furnish in accordance with detail drawings furnished by and included in this contract. They shall apply, however, where such drawings and the specifications cover only the type of device without restriction as to details.

SPECIAL REQUIREMENTS

34. *The Requirement.*—It is required that there be constructed and completed in accordance with these specifications and the drawings hereinbelow listed, (items) (feature) (project) (State). The work is near the line of the Railway and in the vicinity of the towns of

35. *List of Drawings.*

36. *Commencement, Prosecution and Completion of Work.*—Work shall be commenced by the contractor within days, and shall be completed within days after the execution of the contract. The contractor shall at all times during the continuation of the contract prosecute the work with such force and equipment as, in the judgment of the engineer, are sufficient to complete it within the specified time.

37. *Failure to Complete the Work in the Time Agreed upon.*—Should the contractor fail to complete the work or any part thereof in the time agreed upon in the contract, or in such extra time as may have been allowed for delays by formal extensions, a deduction of dollars per day for each schedule will be made for each and every day, including Sundays and holidays, that such schedule remains uncompleted after the date required for the completion. The said amounts are hereby agreed upon as liquidated damages for the loss to on account of all expenses due to the employment of engineers, inspectors and other employees after the expiration of the time for completion and on account of the value of the operation of the works dependent thereon, and will be deducted from any money due the contractor under this contract, and the contractor and his sureties shall be liable for any excess.

38. *Progress Estimates and Payments.*—At the end of each calendar month the engineer will make an approximate measurement of all work done and material delivered up to that date, classified according to items named in the contract, and will make an estimate of the value of the same on the basis of the unit prices named in the contract. To the estimate made as above set forth will be added the amounts earned for extra work to the date of the progress estimate. From

the total thus computed a deduction of 10 per cent will be made and from the remainder there will be further deducted any amount due to from the contractor for supplies or materials furnished or services rendered and any other amounts that may be due to as damages for delays or otherwise under the terms of the contract. From the balance thus determined will be deducted the amount of all previous payments and the remainder will be paid to the contractor upon the approval of the accounts. The 10 per cent deducted as above set forth will become due and payable with and as a part of the final payment to be made as hereinafter provided. In case of the suspension of the contract, the said 10 per cent shall be and become the sole and absolute property of to the extent necessary to repay any excess in the cost of the work above the contract price. When the terms of the contract shall have been fully complied with to the satisfaction of the engineer, final payment will be made of any balance due, including the percentage withheld as above, or such portion thereof as may be due to the contractor.

39. *Materials Furnished by the United States.*—All (list items) , required for the completion of the work in accordance with these specifications, will be furnished to the contractor by and will be delivered to him f. o. b. cars at the railway station most convenient to the work. The contractor shall haul all materials from the points of delivery to the work. He shall provide suitable warehouses for storing materials and will be charged for any material lost or damaged after delivery to him. He shall return to all unused material and will be charged for any material not used and not returned the same amounts that the material cost at the point of delivery to him. When material is furnished to the contractor on cars he shall be responsible for the prompt unloading of such material and will be held liable for any demurrage charges which may be incurred by his failure to unload the material promptly. The cost of unloading, hauling, handling, storing and caring for materials furnished by shall be included in the unit prices bid for the work in which the materials are to be used.

STANDARD PARAGRAPHS FOR PURCHASE OF MATERIAL

40. *Test Pieces.*—The contractor shall provide, at his own expense, the necessary test pieces, and shall notify the engineer or his representative when these pieces are ready for testing. All test bars and test pieces shall be marked so as to indicate clearly the material they represent, and shall be properly boxed and prepared for shipment if required.

41. *Tests.*—Physical tests and chemical analyses of material will be made by at his own expense; or they may be made at the plant by the contractor or his employees, acting under the direction of the engineer or his representative; or certified tests may, at the option of the engineer, be accepted in lieu of the above-mentioned tests.

42. *Shipment.*—All shipments shall be made to the points directed by the engineer.

43. *Payment.*—..... per cent of the contract price of each shipment will be paid on the acceptance of the material by the inspector and receipt by the engineer at of the bill of lading, properly receipted, and the remainder shall be paid when all of the material covered by the contract shall have been received

at its destination and finally inspected, checked and accepted by the engineer, and the terms of the contract shall have been fully complied with to the satisfaction of the engineer.

EARTHWORK ON CANALS

44. *Classification of Excavation.*—All materials moved in the excavation of canals and for structures, and in the construction of embankments will be measured in excavation only, to the neat lines shown in the drawings or prescribed by the engineer, and will be classified for payment as follows:

Class 1: Material that can be plowed to a depth of 6 inches or more with a six-horse or six-mule team, each animal weighing not less than 1400 pounds, attached to a suitable plow, all well handled by at least three men; also all material that is loose and can be handled in scrapers, and all detached masses of rock, not exceeding 2 cubic feet in volume, occurring in loose material or material that can be plowed as specified.

Class 2: Indurated material of all kinds that cannot be plowed as described under class 1 but that, when loosened by powder or other suitable means, can be removed by the use of plows and scrapers, and all detached masses of rock more than 2 and not exceeding 10 cubic feet in volume.

Class 3: All rock in place not included in classes 1 and 2, and all detached masses of rock exceeding 10 cubic feet in volume not included in classes 1 and 2.

If there be required the excavation of any material which, in the opinion of the engineer, cannot properly be included in any of the above three classes, the engineer will determine the actual necessary cost of excavating and disposing of such material and payment therefor as extra work will be made under the provisions of paragraph of these specifications. No additional allowance above the prices bid for the several classes of material will be made on account of any of the material being frozen. It is desired that the contractor or his representative be present during the measurement of material excavated. On written request of the contractor, made by him within ten days after the receipt of any monthly estimate, a statement of the quantities and classifications between successive stations included in said estimate will be furnished him within ten days after the receipt of such request. This statement will be considered as satisfactory to the contractor unless he files with the engineer, in writing, specific objections thereto, with reasons therefor, within ten days after receipt of said statement by the contractor or his representative on the work. Failure to file such written objection with reasons therefor within said ten days shall be considered a waiver of all claims based on alleged erroneous estimate of quantities or incorrect classification of materials for the work covered by such statement.

45. *Canal Sections.*—The canal sections are shown in the drawings, but the undetermined stability of the material that will form the canal banks may make it desirable during the progress of the work to vary the slopes and dimensions dependent thereon. Increase or decrease of quantities excavated as a result of such changes shall be covered in the estimates and shall not otherwise affect the payments due to contractor, unless it is found by the engineer that the unit cost is thereby increased, in which case the engineer will estimate, and include in the amount due the contractor the amount of such increase. The canal shall be excavated to the full depth and width required and must be finished to the prescribed lines and

grades in a workmanlike manner. Runways shall not be cut into canal slopes below the proposed water level. Earth slopes shall be neatly finished with scrapers or similar appliances. Rock bottoms and banks must show no points of rock projecting more than 0.3 foot into the prescribed section. Above the water line the rock will be allowed to stand at its steepest safe angle and no finishing will be required other than the removal of rock masses that are liable to fall. Payment for excavation of canals will be made to the neat lines only as shown in the drawings or as established by the engineer.

46. *Preparation of Surfaces.*—The ground under all embankments that are to sustain water pressure, and the surface of all excavation that is to be used for embankments, shall be cleared of trees, brush and vegetable matter of every kind. The roots shall be grubbed and burned with other combustible material that has been removed. The surface of the ground under the entire embankment shall be scored with a plow making open furrows not less than 8 inches deep below the natural ground surface at intervals of not more than 3 feet. The cost of all work described in this paragraph shall be included in the unit-prices bid for excavation.

47. *Construction of Embankments.*—Embankments built with teams and scrapers or with dump wagons shall be made in layers not exceeding 12 inches in thickness and kept as level as practicable. The travel over the embankments during construction shall be so directed as to distribute the compacting effect to the best advantage. Any additional compacting required over that produced by ordinary travel in distributing the material will be ordered in writing and paid for as extra work under the provisions of paragraph Embankments shall be built to the height designated by the engineer to allow for settlement, and shall be leveled on top to a regular grade. (*Note: If the engineer proposes to permit the use of machinery in canal excavation full specifications should be drafted in each individual case.*) No embankments shall be made from frozen materials nor on frozen surfaces. Should the engineer direct that unsuitable material be excavated and removed from the site of any embankment, the material thus excavated will be paid for as excavation. When canal excavation precedes the building of structures, openings shall be left in the embankments at the sites of these structures and, except when the construction of the structures is included in the contract, the contractor will not be required to complete such omitted embankments. The cost of all work described in this paragraph, except as herein specified, shall be included in the prices bid for excavation.

48. *Disposal of Materials.*—All suitable material excavated in the construction of canals and structures, or so much thereof as may be needed, shall be used in the construction of embankments and in backfilling around structures. Where the canal is on sloping ground, all material taken from the excavation shall be deposited on the lower side of the canal unless otherwise shown in the drawings or directed by the engineer. Where the canal is on level or nearly level ground, the material from the excavation shall be deposited in embankments on both sides to form the top portions of the waterway. If there is an excess of material in excavation it shall be used to strengthen the embankment on either side of the canal as may be directed by the engineer. Material taken from cuts that is not suitable for embankment construction and surplus material may be wasted on the right of way owned by, at such points as shall be approved by the engineer. Unless otherwise shown in the drawings or directed by the engineer, no

material shall be wasted in drainage channels, nor within feet of the edge of the prescribed or actual canal cut. On side hill locations all material wasted shall be placed on the lower side of the canal unless specific written authority is obtained from the engineer to waste such material elsewhere. Waste banks shall be left with reasonably even and regular surfaces. Whenever directed by the engineer, materials found in the excavation, such as sand, gravel or stone, that are suitable for use in structures, or that are otherwise required for special purposes, shall be preserved and laid aside in some convenient place designated by him.

49. *Borrow Pits.*—Where the canal excavation at any section does not furnish sufficient suitable material for embankments, the engineer will designate where additional material shall be procured. Unless otherwise shown on the drawings or directed by the engineer a berm of 10 feet shall be left between the outside toe of the embankment and the edge of the borrow pit, with provision for a side slope of two to one to the bottom of the borrow pit. Borrowed material will be measured in excavation only, and unless the engineer gives the contractor specific written orders to excavate other than class 1 material from borrow pits, all material obtained from this source will be paid for at the unit price bid for class 1 excavation, regardless of its actual character. Payment for excavation from borrow pits will be made for only such quantities as are required for embankments or backfilling or such as by direction of the engineer are excavated and wasted or laid aside.

50. *Overhaul.*—All material taken from the excavation and required for embankment or for other purposes shall be placed as directed by the engineer. The limit of free haul will be 200 feet. Necessary haul over 200 feet will be paid for at the price bid per cubic yard per hundred feet additional haul, but no allowance will be made for overhaul where the excavated material is wasted, except where such overhaul is specifically ordered in writing by the engineer. Where material is taken from borrow pits, the length of the haul will be measured along the shortest practicable route between the center of gravity of the material as found in excavation and the center of gravity of the material as deposited in each station. Where the material is taken from canal excavation, the length of the haul shall be understood to mean the distance measured along the center line of the canal from the center of gravity of the material as found in excavation to the center of gravity of the material as required to be deposited.

51. *Surface and Berm Ditches.*—If, in the judgment of the engineer, it should be necessary to construct surface and berm drainage ditches along the lines of the canal, the contractor shall perform such work and the excavation will be paid for at the unit prices bid in the schedules covering the excavation of the canal along which such surface and berm ditches are built.

52. *Excavation for Structures.*—Unless otherwise shown in the drawings, excavation for structures will be measured for payment to lines outside of the foundation of the structures and to slopes of; provided, that, where the character of the material cut is such that it can be trimmed to the required lines of the concrete structure and the concrete placed against the sides of the excavation without the use of intervening forms, payment for excavation will not be made outside of the required limits of the concrete. The prices bid for excavation shall include the cost of all labor and material for cofferdams and other temporary structures and of all pumping, bailing, draining and all other work necessary to maintain the excavation in good order during construction.

53. *Backfilling.*—The contractor shall place and shall compact thoroughly all backfilling around structures. The compacting must be equivalent to that obtained by the tramping of well distributed scraper teams depositing the material in layers not exceeding 6 inches thick when compacted. The material used for this purpose, the amount thereof and the manner of depositing the same must be satisfactory to the engineer. So far as practicable, the material moved in excavating for structures shall be used for backfilling, but when sufficient suitable material is not available from this source, additional material shall be obtained from borrow pits selected by the engineer. Payment for backfilling will be made at the price per cubic yard bid therefor in the schedule.

54. *Puddling.*—Backfilling and embankment around structures within . . . feet of the structure shall be made with material approved by the engineer, and where practicable shall consist of the sand and gravel, with an admixture of clay equal to one-fourth to one-half the volume of sand and gravel. The material shall be deposited in water of such depth as is approved by the engineer, unless the quantity of clay predominates, in which case the engineer may in his discretion order the material deposited in layers of 6 inches or less, and compacted by tamping or rolling with the smallest quantity of water that will insure consolidation. Payment for the work specified in this paragraph will be made at the unit price bid for puddling and will be in addition to the payment made for excavation and overhaul.

55. *Blasting.*—Any blasting that will probably injure the work will not be permitted, and any damage done to the work by blasting shall be repaired by the contractor at his expense.

CONCRETE

56. *Composition.*—Concrete shall be composed of cement, sand and broken rock or clean gravel, well mixed and brought to a proper consistency by the addition of water. Ordinarily one part by volume, measured loose, of cement shall be used with parts of sand and parts of broken rock or gravel. These proportions may be modified by the engineer as the work or the nature of the materials used may render it desirable, and the contractor shall not be entitled to any extra compensation by reason of such modifications.

57. *Cement.*—Cement for the concrete will be furnished to the contractor by as provided in paragraph The contractor shall give the engineer not less than thirty days' notice in writing of his cement requirements. The requirements shall be stated, so far as practicable, in quantities not less than single car lots. The contractor shall return to the railway station at, all empty sacks securely bound in bundles in such manner and of such sizes as the engineer may direct. For all sacks not returned in serviceable condition, he will be charged the same amount that the sacks cost.

58. *Reinforcement Bars.*—Steel bars shall be placed in the concrete wherever shown in the drawings or prescribed by the engineer. The steel will be furnished to the contractor by as provided in paragraph The exact position and shape of reinforcement bars are not shown in all cases in the drawings accompanying these specifications, but the contractor will be furnished supplemental detailed drawings and lists which will give him the information necessary for cutting, bending and spacing of bars. The steel used for concrete reinforcement shall be so secured in position that it will not be displaced during the deposition

of the concrete, and special care shall be exercised to prevent any disturbance of the steel in concrete that has already been placed. The cost of hauling, storing, cutting, bending, placing and securing in position of reinforcement bars shall be included in the unit price bid for placing reinforcement bars.

59. *Sand*.—Sand for concrete may be obtained from natural deposits or may be made by crushing suitable rock. The sand particles shall be hard, dense, durable rock fragments, such as will pass a $\frac{1}{4}$ -inch mesh screen. The sand must be free from organic matter and must not contain more than 10 per cent of clayey material. The sand must be so graded that when dry and well shaken its voids will not exceed 35 per cent.

60. *Broken Rock or Gravel*.—The broken rock or gravel for concrete must be hard, dense, durable rock fragments or pebbles that will pass through a inch mesh screen when used for plain concrete, and through a inch mesh screen when used for reinforced concrete, and that will be rejected by a $\frac{1}{4}$ -inch mesh screen.

61. *Water*.—The water used in mixing concrete must be reasonably clean and free from objectionable quantities of organic matter, alkali salts and other impurities.

62. *Mixing*.—The cement, sand and broken rock or gravel shall be so mixed and the quantities of water added shall be such as to produce a homogeneous mass of uniform consistency. Dirt and other foreign substance shall be carefully excluded. Machine mixing will be required unless specific authority to use hand mixing is given by the engineer. The machine and its operation shall be subject to the approval of the engineer. Hand mixing, if permitted, shall be thorough and shall be done on a clean, tight floor. In general, enough water shall be used in mixing to give the concrete the consistency ordinarily designated as "wet." Concrete containing a minimum amount of water, ordinarily designated as "dry" concrete, will be permitted only where the nature of the work renders the use of "wet" concrete impracticable. If concrete is mixed in freezing weather, the materials shall be heated sufficiently before mixing to remove all frost and maintain a temperature above 32° F., until the concrete has been placed in the work and has attained its final set.

63. *Placing*.—Concrete shall be placed in the work before the cement takes its initial set. The cement used in any concrete that is wasted or rejected will be charged to the contractor at its cost, at the point of delivery to him. No concrete shall be placed in water except by permission of the engineer and the method of depositing the same shall be subject to his approval. Foundation surfaces upon which concrete is to be placed must be free from mud and débris. When the placing of concrete is to be interrupted long enough for the concrete to take its final set, the working face shall be given a shape, by the use of forms or other means, at the option of the engineer, that will secure proper union with subsequent work. All concrete surfaces upon or against which concrete is to be placed and to which the new concrete is to adhere, shall be roughened, thoroughly cleaned, and wet before the concrete is deposited. "Dry" concrete shall be deposited in layers not exceeding 6 inches in thickness, each of which shall be rammed until water appears on the surface. "Wet" concrete shall be stirred with suitable tamping bars, shovels or forked tools until it completely fills the form, closes snugly against all surfaces and is in perfect and complete contact with any steel used for rein-

forcement. Where smooth surfaces are required a suitable tool shall be worked up and down next to the form until the coarser material is forced back and a mortar layer is brought next to the form. No concrete shall be placed except in the presence of a duly authorized inspector.

64. *Finishing.*—The surface of concrete finished against forms must be smooth, free from projections and thoroughly filled with mortar. Immediately upon the removal of forms all voids shall be neatly filled with cement mortar, irregularities in exposed surfaces shall be removed and minor imperfections of finish shall be smoothed to the satisfaction of the engineer. Exposed surfaces of concrete not finished against forms, such as horizontal or sloping surfaces, shall be brought to a uniform surface and worked with suitable tools to a smooth mortar finish. All sharp angles where required shall be rounded or beveled by the use of moulding strips or suitable moulding or finishing tools.

65. *Protection.*—The contractor shall protect all concrete against injury. Exposed surfaces of concrete shall be protected from the direct rays of the sun and shall be kept damp for at least two weeks after the concrete has been placed. Concrete laid in cold weather shall be protected from freezing by such means as are approved by the engineer. All damage to concrete shall be repaired by the contractor at his expense, in a manner satisfactory to the engineer.

66. *Forms.*—Forms to confine the concrete and shape it to the required lines shall be used wherever necessary. Where the character of the material cut into to receive a concrete structure is such that it can be trimmed to the prescribed lines, the use of forms will not be required. The forms shall be of sufficient strength and rigidity to hold the concrete and to withstand the necessary pressure and ramming without deflection from the prescribed lines. For concrete surfaces that will be exposed to view and for all other concrete surfaces that are to be finished smooth, the lagging of forms must be surfaced and bevel-edged or matched; provided, that smooth metal forms may be used if desired. All forms shall be removed by the contractor, but not until the engineer gives permission. Forms may be used repeatedly provided they are maintained in serviceable condition and thoroughly cleaned before being re-used.

67. *Measurement.*—Concrete will be measured for payment to the neat lines shown in the drawings or prescribed by the engineer under these specifications. No payments will be made for concrete outside of the prescribed lines and in case cavities resulting from careless excavation are required to be filled with concrete, the cement used for such refilling will be charged to the contractor at its cost at the point of delivery to him.

68. *Payment.*—The unit price bid for concrete shall include all material and labor entering into its construction, except that cement will be furnished as provided in paragraph , and reinforcement bars will be furnished when required as provided in paragraph

STRUCTURAL STEEL

Based on "Standard Specifications for Structural Steel for Buildings" of the American Society for Testing Materials, adopted August 25, 1913.

69. *Manufacture.*—Structural steel may be made by either the open-hearth or Bessemer process. Rivet steel and plate or angle material over $\frac{1}{2}$ inch thick, which is punched, shall be made by the open-hearth process. The steel shall

conform in all respects, not specifically mentioned herein, to the "Standard Specifications for Structural Steel for Buildings" of the American Society for Testing Materials, adopted August 25, 1913, and tests shall be made as provided in said specifications.

70. *Chemical and Physical Properties of Structural Steel.*—Steel made by the Bessemer process shall contain not more than 0.10 per cent phosphorus and steel made by the open-hearth process shall contain not more than 0.06 per cent phosphorus. All structural steel shall have an ultimate tensile strength of 55,000 to 65,000 pounds per square inch; an elastic limit, as determined by the drop of the beam, of not less than one-half the ultimate tensile strength; a minimum per cent of elongation in 8 inches of 1,400,000 divided by the ultimate tensile strength; a silky fracture; and capability of being bent cold without fracture 180° flat on itself for $\frac{3}{4}$ -inch material and under; around a pin having a diameter equal to the thickness of the test piece for material over $\frac{3}{4}$ inch to and including $1\frac{1}{4}$ inches; and around a pin having a diameter equal to twice the thickness of the test piece for material over $1\frac{1}{4}$ inches in thickness. A deduction of 1 from the specified percentage of elongation will be allowed for each $\frac{1}{2}$ inch in thickness above $\frac{3}{4}$ -inch; and a deduction of 2.5 will be allowed for each $\frac{1}{8}$ inch in thickness below $\frac{3}{8}$ inch.

71. *Chemical and Physical Properties of Rivet Steel.*—Rivet steel shall contain not more than 0.06 per cent phosphorus nor more than 0.045 per cent sulphur. It shall have an ultimate tensile strength of 48,000 to 58,000 pounds per square inch; an elastic limit of one-half the ultimate tensile strength; a minimum per cent of elongation in 8 inches of 1,400,000 divided by the ultimate tensile strength; a silky fracture; and capability of being bent cold without fracture 180° flat on itself.

72. *Finish.*—Finished material must be free from injurious seams, flaws, or cracks, and have a workmanlike finish.

73. *Marking.*—Every finished piece of steel shall be stamped with the melt or blow number, except that small pieces may be shipped in bundles securely wired together with the melt or blow number on a metal tag attached.

74. *Test Pieces.*—(See paragraph 40.)

75. *Tests.*—(See paragraph 41.)

76. *Payment.*—(See paragraph 43.)

STEEL REINFORCEMENT BARS

Based on "Standard Specifications for Billet-Steel Concrete Reinforcement Bars" of the American Society for Testing Materials, adopted August 25, 1913.

77. *Manufacture.*—Steel may be made by either the open-hearth or Bessemer process and the bars shall be rolled from billets. It shall conform in all respects, not specifically mentioned herein, to the "Standard Specifications for Billet-steel Concrete Reinforcement Bars" of the American Society for Testing Materials adopted August 25, 1913, and tests shall be made as provided in said specifications.

78. *Type of Bars.*—All reinforcement bars shall be of the deformed type. Bidders shall submit samples or cuts of the type of bar they propose to furnish.

79. *Chemical Properties.*—Bars of steel made by the Bessemer process shall contain not more than 0.10 per cent phosphorus, and not more than 0.05 per cent phosphorus if made by the open-hearth process.

80. *Physical Properties.*—Bars of steel shall have an ultimate tensile strength of 55,000 to 70,000 pounds per square inch; an elastic limit of not less than 33,000 pounds per square inch; a minimum per cent of elongation in 8 inches of 1,250,000 divided by the ultimate tensile strength; and capability of being bent cold without fracture 180° around a pin having a diameter equal to the thickness of the test piece for material less than $\frac{3}{4}$ inch in thickness, and around a pin having a diameter equal to twice the thickness of the test piece for material of $\frac{3}{4}$ inch and over in thickness. For each increase of $\frac{1}{8}$ inch in diameter or thickness above $\frac{3}{4}$ inch and for each decrease of $\frac{1}{8}$ inch in diameter or thickness below $\frac{3}{4}$ inch, a deduction of 1 will be allowed from the specified percentage of elongation.

81. *Variation in Weight.*—Bars for reinforcement are subject to rejection if the actual weight of any lot varies more than 5 per cent over or under the theoretical weight of that lot.

82. *Finish.*—Finished material shall be free from injurious seams, flaws, or cracks, and shall have a workmanlike finish.

83. *Test Pieces.*—(See paragraph 40.)

84. *Tests.*—(See paragraph 41.)

85. *Payment.*—(See paragraph 43.)

GRAY IRON CASTINGS

Based on "Standard Specifications for Gray Iron Castings" of the American Society for Testing Materials, adopted September 1, 1905.

86. *Manufacture.*—Castings shall be of tough gray iron made by the cupola process. In all respects, not specifically mentioned herein the castings shall conform to the "Standard Specifications for Gray Iron Castings" of the American Society for Testing Materials, adopted September 1, 1901, and tests shall be made as provided in said specifications.

87. *Light Castings, Physical and Chemical Properties.*—Castings having any section less than $\frac{1}{2}$ inch thick shall be known as light castings. The sulphur content shall be not greater than 0.08 per cent. The minimum breaking load of a bar $1\frac{1}{2}$ inches in diameter, loaded at the middle of a 12-inch span, shall be 2500 pounds. The deflection shall in no case be less than 0.1 inch.

88. *Heavy Castings, Physical and Chemical Properties.*—Castings in which no section is less than 2 inches thick shall be known as heavy castings. The sulphur content shall be not greater than 0.12 per cent. The minimum breaking load of a bar $1\frac{1}{2}$ inches in diameter, loaded at the middle of a 12-inch span shall be 3300 pounds. The deflection shall in no case be less than 0.1 inch.

89. *Medium Castings, Chemical and Physical Properties.*—Medium castings are those not included under "light" or "heavy" castings. Their sulphur content shall be not greater than 0.10 per cent. The minimum breaking load of a bar $1\frac{1}{2}$ inches in diameter loaded at the middle of a 12-inch span shall be 2900 pounds. The deflection shall in no case be less than 0.1 inch.

90. *Finish.*—All castings shall be true to pattern, free from cracks, flaws, porosity, cold-shuts, blow-holes and excessive shrinkage and shall have a workmanlike finish.

91. *Test Pieces.*—(See paragraph 40.)

92. *Tests.*—(See paragraph 41.)

93. *Payment.*—(See paragraph 43.)

MALLEABLE CASTINGS

Based on "Standard Specifications for Malleable Castings" of the American Society for Testing Materials, adopted November 15, 1904.

94. *Manufacture*.—Malleable iron castings may be made by the open-hearth or air furnace process. In all respects not specifically mentioned herein the castings shall conform to the "Standard Specifications for Malleable Castings" of the American Society for Testing Materials, adopted November 15, 1904, and tests shall be made as provided in said specifications.

95. *Chemical and Physical Properties*.—Castings shall contain not more than 0.06 per cent of sulphur nor more than .0225 per cent of phosphorus. They shall have a tensile strength of not less than 40,000 pounds per square inch and the elongation measured in 2 inches shall not be less than 2½ per cent. The transverse strength of the standard test bar 1 inch square, loaded at the middle of a 12-inch span shall be not less than 3000 pounds per square inch; and the deflection shall be at least ¼ inch.

96. *Finish*.—Castings shall be true to pattern, free from blemishes, scale and shrinkage cracks, and shall have a workmanlike finish.

97. *Test Pieces*.—(See paragraph 40.)

98. *Tests*.—(See paragraph 41.)

99. *Payment*.—(See paragraph 43.)

STEEL CASTINGS

Based on "Standard Specifications for Steel Castings" of the American Society for Testing Materials, adopted August 25, 1913.

100. *Manufacture*.—Steel for castings may be made by the open-hearth, crucible or Bessemer process. Castings shall be annealed unless otherwise specified, and in all respects not specifically mentioned herein their material and manufacture shall conform to the Standard Specifications for Steel Castings of the American Society for Testing Materials adopted August 25, 1913, and tests shall be made as provided in said specifications.

101. *Chemical and Physical Properties*.—Castings shall contain not more than 0.05 per cent of phosphorus nor more than 0.05 per cent of sulphur. Castings shall be classed as "Hard," "Medium" and "Soft" and shall have the following physical properties:

	Hard.	Medium.	Soft.
Tensile strength, pounds per square inch.....	80,000	70,000	60,000
Elastic limit.....	36,000	31,500	27,000
Elongation, per cent in 2 inches.....	15	18	22
Contraction of area, per cent.....	20	25	30

102. *Finish*.—Casting shall be true to pattern, free from blemishes, flaws or shrinkage cracks. Bearing surfaces shall be solid and no porosity shall be allowed in positions where the resistance and value of the casting for the purpose intended will be seriously affected thereby.

103. *Test Pieces*.—(See paragraph 40.)

104. *Tests*.—(See paragraph 41.)

105. *Payment*.—(See paragraph 42.)

CEMENT

106. *The Requirement.*—It is required that there be furnished in accordance with these specifications the quantity of Portland cement set forth in the accompanying advertisement, f. o. b. cars at the place named by the bidder in his proposal. The right is reserved by to increase or decrease the quantity to an extent not to exceed 20 per cent. The contractor shall store cement in sufficient quantities to provide for the completion of necessary tests thereon before shipment is required.

107. *Progress Estimates and Payments.*—At the end of each calendar month the engineer will prepare a statement of the amount of cement delivered to that date and an estimate of the value of the same on the basis of the unit price named in the contract. From the total thus computed there will be deducted any amount due from the contractor under the terms of the contract. From the amount thus determined will be deducted the sum of all previous payments and the remainder will be paid to the contractor on approval of the accounts.

108. *Definition.*—The cement shall be the product obtained by finely pulverizing clinker produced by calcining to incipient fusion, an intimate mixture of properly proportioned argillaceous and calcareous substances, with only such additions subsequent to calcining as may be necessary to control certain properties. Such additions shall not exceed 3 per cent, by weight, of the calcined product.

109. *Composition.*—In the finished cement, the following limits shall not be exceeded:

Loss on ignition for 15 minutes.	4 per cent
Insoluble residue.	1 “
Sulphuric anhydride (SO ₃).	2 “
Magnesia (MgO).	5 “

110. *Specific Gravity.*—The specific gravity of the cement shall be not less than 3.10. Should the cement as received fall below this requirement, a second test may be made upon a sample heated for thirty minutes at a very dull red heat.

111. *Fineness.*—At least 78 per cent of the cement by weight, shall pass through the No. 200 sieve.

112. *Soundness.*—Pats of neat cement prepared and treated as hereinafter prescribed shall remain firm and hard and show no sign of distortion, checking, cracking, or disintegrating. If the cement fails to meet the prescribed steaming test, the cement may be rejected or the steaming test repeated after seven or more days at the option of the engineer.

113. *Time of Setting.*—The cement shall not acquire its initial set in less than forty-five minutes and must have acquired its final set within ten hours.

114. *Tensile Strength.*—Briquettes made up of 1 part cement and 3 parts standard Ottawa sand, by weight, shall develop tensile strength per square inch as follows:

After 7 days, 1 day in moist air, 6 days in water.	200 pounds
After 28 days, 1 day in moist air, 27 days in water.	300 “

The average of the tensile strengths developed at each age by the briquettes in any set made from one sample is to be considered the strength of the sample

at that age, excluding any results that are manifestly faulty. The average strength of the briquettes at 28 days shall show an increase over the average strength at 7 days.

115. *Brand.*—Bids for furnishing cement or for doing work in which cement is to be used shall state the brand of cement proposed to be furnished and the mill at which made. The right is reserved to reject any cement which has not established itself as a high-grade Portland cement, and has not been made by the same mill for two years and given satisfaction in use for at least one year under climatic and other conditions at least equal in severity to those of the work proposed.

116. *Packages.*—The cement shall be delivered in sacks, barrels, or other suitable packages (to be specified by the engineer), and shall be dry and free from lumps. Each package shall be plainly labeled with the name of the brand and of the manufacturer. A sack of cement shall contain 94 pounds net. A barrel shall contain 376 pounds net. Any package that is short weight or broken or that contains damaged cement may be rejected, or accepted as a fractional package, at the option of the engineer. If the cement is delivered in cloth sacks, the sacks used shall be strong and serviceable and securely tied, and the empty sacks will, if practicable, be returned to the contractor at the point of delivery of the cement. On final settlement under the contract, cents will be paid the contractor for each sack furnished by him in accordance with the above requirements and not returned in serviceable condition.

117. *Inspection.*—The cement shall be tested in accordance with the standard methods hereinafter prescribed. In general the cement will be inspected and tested after delivery, but partial or complete inspection at the mill may be called for in the specifications or contract. Tests may be made to determine the chemical composition, specific gravity, fineness, soundness, time of setting, and tensile strength, and a cement may be rejected in case it fails to meet any of the specified requirements. An agent of the contractor may be present at the making of the tests or they may be repeated in his presence.

CONTINUOUS WOOD STAVE PIPE

118. *Description.*—The pipe shall be of the continuous-stave metal-banded type with metal tongues driven into slots in the ends of the staves to form the butt joints. The alinement and profile of the pipe are shown in the drawings. Each proposal shall be accompanied by drawings showing clearly detail dimensions of staves, bands and tongues, which shall comply with the requirements of the specifications. Omission of drawings from proposals or any uncertainty as to detail dimensions will be sufficient cause for rejection.

119. *Material.*—All material of whatever nature required in the work shall be furnished by the contractor. The price bid for wood staves in place shall include the cost of all necessary tongues, and all royalties for special material or devices used in the pipe or in its construction. The price bid for bands in place shall include all necessary shoes and fastenings and asphaltum coating, and all royalties for special devices used in the pipe or in its construction.

120. *Diameter of Pipe.*—The inside diameter of the pipe shall be inches, measured after completion of the work. No diameter at any point shall differ more than 2 per cent from the average diameter of the pipe at said point, and

the average of the vertical and horizontal diameters at any point shall not be less than the specified diameter.

121. *Staves*.—All lumber used in staves shall be Douglas fir or redwood. It shall be sound, straight-grained, and free from dry rot, checks, wind shakes, wane, and other imperfections that may impair its strength or durability. Redwood shall be clear and free from sap. In Douglas fir sap will not be allowed on more than 10 per cent of the inside face of any stave and in not more than 10 per cent of the total number of pieces; sap shall be bright and shall not occur within 4 inches of the ends of any piece; pitch seams will be permitted in not over 10 per cent of the total number of pieces, if showing on the edge only, and if not longer than 4 inches nor wider than $\frac{1}{4}$ inch; no through knots nor knots at edge nor within 6 inches of ends of staves will be allowed; sound knots not exceeding $\frac{1}{2}$ inch in diameter, not falling within the above limitations, nor exceeding three within a 10-foot length will be accepted. All lumber used shall be seasoned by not less than sixty days' air drying in open piles before milling or by thorough kiln drying. All staves shall have smooth planed surfaces and the inside and outside faces shall be accurately milled to the required circular arcs to fit a standard pattern provided by the contractor. Staves shall be trimmed perfectly square at ends and the slots for tongues shall be in exactly the same relative position for all ends and according to detail drawings furnished by the contractor. Staves shall have an average length of not less than 15 feet 6 inches and not more than 1 per cent of the staves shall have a length of less than 9 feet 6 inches. No staves shorter than 8 feet will be accepted. The finished thickness of staves shall not be less than inches. All staves delivered on the work in a bruised or injured condition will be rejected. If staves are not immediately used on arrival at the site of the work, they shall be kept under cover until used.

122. *Bands*.—A band shall consist of one complete fastening and shall include the bolts, shoes, nuts and washers necessary to form same.

123. *Band Spacing*.—The distance center to center of bands shall be as marked on the profile, except that where the spacing as marked is such as to make the distances from bands to the ends of staves more than 4 inches extra bands shall be used to keep such distances within 4 inches.

124. *Bolts*.—All bolts shall be of inch diameter steel and shall conform to the following specifications: (See specifications for structural steel.) Bolts may have either button or bolt heads. They shall be at least as strong in thread as in body and threads shall permit the nut to run freely for the entire length of thread. Nuts shall be of such thickness as to insure against stripping of threads.

125. *Shoes*.—There shall be malleable iron shoes to each band. Shoes shall fit accurately to the outer surface of the pipe and shall have the dimensions shown on the drawing, or the contractor may submit for approval a drawing or sample of some other type of shoe which he may desire to furnish. If required, such shoe shall be shown under suitable test to be stronger than the bolt. The material for shoes shall conform to the following specifications: (See standard specifications for malleable castings.)

126. *Tongues*.—Shall be of galvanized steel or iron inch thick and wide. Their length shall be such, that when in place, they will penetrate into the sides of the adjacent staves without undue injury. The tongues and slots shall be

so proportioned as to insure a tight fit of the tongues into the slots without danger of splitting the staves.

127. *Coating of Bands.*—The bands shall be coated by being dipped when hot in a mixture of pure California asphalt, or equivalent. Bolts shall be bent to the required arc before dipping. If the bands are dipped cold they shall be left in the hot bath a sufficient length of time to insure that they have acquired the temperature of the asphalt. This coating shall be so proportioned and applied that it will form a thick and tough coating free from tendency to flow or become brittle under the range of temperature to which it will be subjected. Where the pipe is uncovered and exposed to the full range of atmospheric temperatures, not less than 7 per cent and not more than 10 per cent of pure linseed oil shall be mixed with the asphalt.

128. *Erection.*—The pipe shall be built in a workmanlike manner. The ends of adjoining staves shall break joint at least 3 feet. The staves shall be driven in such a manner as to avoid any tendency to cause wind in the pipe and the required grade and alinement must be maintained. Staves shall be well driven to produce tight butt joints, driving bars or other suitable means being used to avoid marring or damaging staves in driving. In rounding out the pipe, care shall be exercised to avoid damage by chisels, mauls or other tools. The pipe shall be rounded out to produce smooth inner and outer surfaces. Bands shall be accurately spaced and placed perpendicular to the axis of the pipe. Shoes shall be placed so as to cover longitudinal joints between staves and bear equally on two staves as nearly as practicable. They shall be placed alternately on opposite sides of the pipe so as to be out of line and cover successively on each side at least three joints. Shoes shall not be allowed to cover the butt joints. Bolts shall be hammered thoroughly into the wood to secure a bearing on 60 degrees of the circumference of the bolt. All kinks in bolts shall be carefully hammered out. Bands shall be back-cinched to the satisfaction of the engineer so as to produce the required initial compressive stresses in the staves. All metal work shall be handled with reasonable care so as to avoid injury to the coating as much as possible. In hammering shoes into place they shall be struck so as to avoid deformation or injury. After erection the contractor shall retouch all metal work, where abraded, with an asphaltum paint satisfactory to the engineer.

129. *Painting.*—After erection and while the pipe is dry the entire outer surface shall be given a coat of refined water-gas tar, followed by a coat of refined coal-gas tar, thinned with distillate, applied with brushes or sprayed on with air pressure. Before application of the paint the surface of the pipe shall be thoroughly cleaned of dirt, dust and foreign matter of every kind. All checks, cracks and surface irregularities of every kind shall be thoroughly filled with paint. The finished thickness of the coating shall be not less than $\frac{1}{8}$ inch. The cost of all work under this paragraph shall be included in the price bid for pipe in place.

130. *Inspection.*—Final inspection of materials, as well as erection will be made on the work, but if the contractor so desires, preliminary inspection of staves may be made at the mill at the contractor's expense. Mill inspection, however, shall not operate to prevent the rejection of any faulty material on the work. Tests of metal work will be made at the point of manufacture by at his own expense; or they may be made at the plant by the contractor or his employees acting under the direction of the engineer or his representative; or certified tests

may, at the option of the engineer, be accepted in lieu of the above-mentioned tests. The contractor shall provide, at his own expense, the necessary test pieces, and shall notify the engineer or his representatives when these pieces are ready for testing. All test bars and test pieces shall be marked so as to indicate clearly the material that they represent, and shall be properly boxed and prepared for shipment if required.

131. *Tests of Pipe.*—On completion of the work, or as soon as possible thereafter, the contractor shall make a full pressure test of the pipe, water being furnished therefor by All leaks found at the time of the test shall be made tight by the contractor. If the leakage is not so large as to endanger the foundation of the pipe, the pipe shall be kept under full pressure for two days before plugging of leaks is started in order to allow the wood to become thoroughly saturated. The cost of making the test, except furnishing water, shall be borne by the contractor.

132. *Payments.*—At the end of each calendar month 50 per cent of the price for material in place shall be paid to the contractor for material delivered on the work; 25 per cent additional shall be paid after erection and preliminary cinching; and the remainder shall be paid after final test and acceptance of the pipe by the engineer and when the terms of the contract shall have been fully complied with to the satisfaction of the engineer, and a release of all claims against, under, or by virtue of the contract, shall have been executed by the contractor.

MACHINE BANDED WOOD STAVE PIPE

133. *Description.*—The pipe shall be of the jointed, wood-stave, machine banded type.

134. *Lengths of Pipe Sections.*—Pipe shall be furnished in lengths of 10 to 20 feet and the average length shall be not less than 16 feet. Shorter sections shall be furnished only if required for making sharp curves in which case the lengths shall not be more than 1 foot shorter than will be required to keep the joint opening at the outside of the curve due to throw within a limit of $\frac{1}{16}$ inch.

135. *Material.*—All material of whatever nature required in the manufacture of the pipe in accordance with these specifications shall be furnished by the contractor.

136. *Diameter of Pipes.*—The diameters of pipes shall be as listed in the schedules. No diameter of any pipe shall differ more than 1 per cent from the specified diameter of the pipe, and the average of the vertical and horizontal diameters at any point shall not be less than the specified diameter.

137. *Thickness of Staves.*—The finished thickness of staves shall be as follows:

4 to 6 inches	$1\frac{1}{16}$
8 to 10 "	$1\frac{1}{8}$
12 to 14 "	$1\frac{1}{4}$
16 to 18 "	$1\frac{1}{2}$
20 to 24 "	$1\frac{3}{8}$

138. *Lumber for Staves.*—All lumber used in staves shall be Douglas fir or redwood. It shall be sound, straight-grained, and free from dry rot, checks, wind

shakes, wane and other imperfections that may impair its strength or durability. Redwood shall be clear and free from sap. In Douglas fir sap will not be allowed on more than 10 per cent of the inside face of any stave and in not more than 10 per cent of the total number of pieces; sap shall be bright and shall not occur within 4 inches of the ends of any piece; pitch seams will be permitted in not over 10 per cent of the total number of pieces, if showing on the edge only, and if not longer than 4 inches nor wider than $\frac{1}{8}$ inch; no through knots or knots at edges or within 6 inches of ends of staves will be allowed; sound knots not exceeding $\frac{1}{2}$ inch in diameter, not falling within the above limitations, nor exceeding three within a 10-foot length will be accepted. All lumber used shall be seasoned by not less than sixty days' air drying in open piles before milling or by thorough kiln drying. All staves shall have smooth planed surfaces and the inside and outside faces shall be accurately milled to the required circular arcs.

139. *Banding*.—Size and spacing of banding wire shall be adjusted for a working stress of 12,000 pounds per square inch on the wire. The spacing shall in no case be greater than 4 inches center to center of wires, nor greater than will produce a pressure of wire on the wood of 800 pounds per square inch as calculated from the formula $B = \frac{pRf}{r(R+t)}$, where B = pressure on wood in pounds per square inch; p = water pressure in pounds per square inch; f = spacing of wire in inches; R = inside radius of pipe in inches; r = radius of wire in inches; and t = thickness of staves in inches. No wire smaller than No. 8 U. S. Standard gage shall be used. Wire shall be of medium steel double-galvanized and shall have an ultimate tensile strength of 55,000 to 65,000 pounds per square inch, and capability of being bent flat on itself without fracture. The bidder shall state in his proposal the size of banding wire he proposes to furnish.

140. *Joints*.—Inserted joint pipe shall be furnished for diameters of 12 inches and less and for heads not exceeding 50 feet. For pipes of larger diameter than 12 inches and for all pipes under more than 50 feet head, wood sleeve collars shall be furnished. The banding on collars shall be 50 per cent stronger than the banding on the pipe.

141. *Individual Bands*.—Individual bands shall be used on all collars for pipe 12 inches and greater in diameter. The smallest bolts used shall be $\frac{3}{8}$ inch in diameter. The bolt shall have an ultimate tensile strength of 55,000 to 65,000 pounds per square inch; an elastic limit of one-half the ultimate tensile strength and capability of being bent back flat on itself without fracture. The shoes shall be malleable iron and shall be stronger than the bolts, with sufficient bearing on the wood at the tail to prevent injurious indentation in cinching. The shoes shall be sound and free from blow-holes, and shall have an ultimate tensile strength of not less than 40,000 pounds per square inch. Bidders shall submit samples or drawings of the type of shoe they propose to furnish.

142. *Coating*.—After manufacture the outside of the pipe and collars shall be dipped in a bath of hot coal tar and asphaltum. Previous to dipping the collars in coal tar and asphaltum they shall be dipped for a depth of 1 inch at each end for a period of ten minutes in a bath of creosote. Care should be exercised to keep the coal tar and asphaltum from the tenon ends and inside surfaces and, if necessary, the tenons shall be wrapped with paper while being dipped. After dipping the pipe and collars shall be rolled in fine sawdust while the coating is still soft.

143. *Inspection.*—Inspection of pipe will be made at the mill, but the manufacturer will be held responsible for any damage in transit caused by improper loading of the pipe.

144. *Marking.*—Each section of pipe shall be plainly marked on the inside at one end, showing the head for which the section was wound, and the number of the banding wire used.

LAYING MACHINE BANDED WOOD STAVE PIPE

145. *Point of Delivery.*—Pipe will be delivered f. o. b. cars at in lengths of 12 to 20 feet. The contractor shall unload cars at once and will be held responsible for all demurrage charges.

146. *Handling.*—In unloading and hauling, the pipe shall be handled carefully. To avoid injury to the ends, the pipe should not be carried by means of sticks inserted in the ends. The contractor will be held responsible for any damage due to careless handling.

147. *Laying.*—The pipe should be laid with coupling or mortise end in the direction of the laying. Care should be taken in inserting the tenon to see that it is started around the entire circumference and the joint should first be driven lightly until it is assured that a good connection is being made, then drive to the shoulder. The bands on couplings should not be fully cinched until the joint has been driven home. The bands on couplings should be placed symmetrically about the middle of the coupling and in cinching a few turns should be given alternately to each band in order to maintain approximately the same tension on each.

148. *Alinement and Grade.*—In laying the pipe true alinement and grade must be maintained. If necessary, short sections of pipe shall be used for making sharp curves and the pipe shall be anchored by staking the outside at each joint. Curves shall be made by driving the joint on a tangent and then springing into place.

149. *Fittings.*—Elbows, tees and other special fittings shall be securely anchored in concrete as directed by the engineer.

150. *Tests.*—After the pipe has been laid it shall be subjected to the full pressure of water and the contractor shall stop all leaks. Damages to the pipe caused by the pressure of water, that are due to improper or careless laying shall be repaired by the contractor, but he shall not be responsible for damages due to defective manufacture. If the leakage is not so large as to endanger the foundation of the pipe, it shall be kept under full pressure for two days before plugging of leaks is started in order to allow the wood to become thoroughly saturated. Water for tests will be furnished by, but the expense of making the test, except furnishing water, shall be borne by the contractor.

151. *Payments.*—On the completion of a pipe line per cent of the contract price, on the basis of the unit price bid per linear foot of pipe in place, will be made. The remainder will be paid after final test and acceptance of the pipe by the engineer, and when the terms of the contract shall have been fully complied with to the satisfaction of the engineer, and a release of all claims against under, or by virtue of the contract, shall have been executed by the contractor.

STEEL PIPE

152. *Description.*—Steel pipe may be either of the lockbar or riveted steel type. Riveted steel pipe shall have { in and out taper } courses. Circular seams may be single-riveted and longitudinal seams shall be { triple double } riveted. The bidder shall submit with his bid a drawing showing details of joints, size and spacings of rivets, etc. Failure to submit such drawing will be sufficient cause for rejection of the bid.

153. *Thickness of Metal.*—The thickness of steel sheets shall be as follows:

Length, Feet.	Thickness, Inches.		Head, Feet.
	Riveted.	Lockbar.	
.....			
.....			
.....			
.....			

154. *Planing and Scarfing.*—When necessary the edges of plates shall be prepared for caulking by planing and scarfing at the factory.

155. *Riveting.*—The riveting and other details of longitudinal seams shall be designed to withstand the heads given in paragraph 198. The rivets for circular joints shall be of the same size as for longitudinal seams. The intensity of working stress on rivets shall be 7500 pounds per square inch in shear and 15,000 pounds per square inch in bearing on riveted plates. All rivet spacing shall be arranged to give the greatest possible efficiency of joint. Size of rivets and rivet spacing shall be submitted to the engineer for approval. All riveting shall be done in the field, but sufficient of the work done with different templates must be assembled at the shop to prove the work correct. (*When appropriate shop riveting should be specified.*)

156. *Punching.*—Rivet holes may be punched and shall be no larger than is necessary to pass the required size of rivet. Drift pins shall not be used except for bringing together the several parts, and drifting with such force as to distort the holes will not be allowed. Wrongly punched plates shall not be corrected by plugging the holes and a re-punching, but shall be rejected. All burrs and ragged edges on plates shall be smoothed off before leaving the shop. All punching shall be done at the shop before shipment.

157. *Material.*—All steel shall be made by the open-hearth process. Steel for plates shall be of the grade known as "boiler plate." Steel for rivets shall be of the grade known as "boiler rivet steel."

158. *Chemical and Physical Properties of Boiler Plate Steel.*—Boiler plate steel shall contain not more than .05 per cent phosphorus, .05 per cent sulphur, and from 0.30 to 0.60 per cent manganese. It shall show an ultimate tensile strength of 55,000 to 65,000 pounds per square inch; an elastic limit of not less than one-half the ultimate tensile strength; an ultimate elongation in 8 inches of not less than 1,500,000 divided by the ultimate tensile strength; and capability of being bent, cold or quenched, 180° flat without fracture. The steel shall be in all respects such as to stand punching, caulking and riveting without showing the least tendency to crack. Plates shall withstand, without cracking of the material, a drift test made by driving a pin into a ¾-inch hole, enlarging same to a diameter of 1 inch. In all respects not covered in these specifications boiler plate steel shall conform to the "Standard Specifications for Boiler Steel" of the American Society for Testing Materials, adopted August 25, 1913.

159. *Chemical and Physical Properties of Rivet Steel.*—Steel for rivets shall contain not more than 0.04 per cent of phosphorus, 0.45 per cent sulphur, and from 0.30 to 0.50 per cent of manganese. It shall show an ultimate tensile strength of 45,000 to 55,000 pounds per square inch; an elastic limit of not less than one-half the ultimate tensile strength; an ultimate elongation in 8 inches of not less than 1,500,000 divided by the ultimate tensile strength, but need not exceed 30 per cent; and capability of being bent, cold or quenched, 180° flat without fracture. Rivet rounds shall be tested of full size as rolled. In all respects not covered in these specifications steel for rivets shall conform to the "Standard Specifications for Boiler Rivet Steel" of the American Society for Testing Materials, adopted August 25, 1913.

160. *Marking.*—Each plate shall be distinctly stamped with its melt or slab number. Rivet steel may be shipped in securely fastened bundles with melt number stamped on a metal tag attached. Plates and other parts shall be plainly marked for identification and assembly in the field.

161. *Test Pieces.*—(See paragraph 40.)

162. *Test of Material.*—(See paragraph 41.)

163. *Erection.*—Erection of pipe shall be commenced at the point directed by the engineer. The contractor shall haul all material and distribute same along the trench and shall furnish a compressed air plant and full equipment for air riveting, and all other equipment, tools and supplies required for the erection of the pipe and completion for service. The pipe shall be carefully caulked and painted as the work progresses. The work of assembling, riveting and caulking shall be done by workmen experienced in this line. Riveting shall show first class workmanship, rivet heads shall be full and concentric with the body of the rivet, and the rivet shall completely fill the hole and thoroughly pinch the connected pieces together. Rivets that are loose or have defective heads shall be removed and other rivets substituted therefor.

164. *Painting.*—Inside and outside of pipe shall be covered with three coats of a reliable brand of asphalt paint which shall be subject to the approval of the engineer. Before painting all surfaces shall be thoroughly cleaned by scrubbing with wire brushes or other means as directed by the engineer. All riveted joints shall be painted before riveting. All paint shall be applied while the pipe is warm and thoroughly dry.

165. *Defective Work.*—The contractor shall guarantee the material and work-

manship furnished by him to be free from defects of material and construction, and he shall replace free of cost to any material that shall develop faults during construction or tests.

166. *Test of Pipe.*—On completion of erection, or as soon as possible thereafter, the contractor shall make a full pressure test of the pipe, water therefor being furnished by The pipe shall be water-tight under this test and the contractor shall correct any defects that develop.

JOINTED REINFORCED CONCRETE PIPE

167. *Description.*—The pipe shall be composed of concrete reinforced with steel rods or wire and built in vertical forms in lengths of feet; the sections being connected in the trench by concrete collars reinforced with steel.

168. *Diameter of Pipe.*—The inside diameter of the pipe shall be inches and no diameter shall differ more than 0.5 per cent from the specified diameter of the pipe. Each section of pipe shall be a true right cylinder with the plane of the ends perpendicular to the axis of the pipe.

169. *Thickness of Shell.*—The shell of the pipe shall have a thickness of inches which shall be uniform around the entire circumference. In no case will a variation of more than 10 per cent from the specified thickness be allowed.

170. *Manufacture.*—The concrete shall be thoroughly mixed in a mechanical batch mixer. It shall be deposited in such a manner that no separation of ingredients will occur and suitable tools shall be used to thoroughly settle the concrete and produce smooth surfaces. Great care shall be exercised to maintain proper spacing of the reinforcing rods. No pipe shall be manufactured when the temperature of the atmosphere is above 90°, except by permission of the engineer. During manufacture the concrete and forms shall be protected from the direct rays of the sun, and for five days thereafter the sections shall be kept both moist and covered, and they shall be kept moist for fifteen days additional. Manufacture shall not be carried on in freezing weather, except in a heated enclosure and the sections of pipe shall be prevented from freezing. Immediately after removal of the forms all defects in the surface of the concrete shall be smoothed up with a 1 to 1 mixture of cement and fine sand, especial care being taken to produce smooth interior surfaces. Forms shall not be removed in less than twenty-four hours after the concrete has been poured.

171. *Forms.*—The forms used shall be subject to the approval of the engineer. All steel forms are preferred, but wooden forms with steel linings may be used provided the desired results can be obtained therewith. Forms shall be strong and rigid with sufficient bracing to prevent warping in handling, or pouring concrete. They shall be provided with suitable attachments for making the joint grooves at the ends in accordance with the drawings. A sufficient number of forms shall be provided to allow the manufacture of not less than sections of pipe per day, or such additional number as may be necessary to complete the work within the specified time.

172. *Reinforcement.*—The transverse reinforcement shall consist of medium steel rods or wire and shall be spaced as shown on the drawings. Sufficient longitudinal reinforcement shall be used to fasten the transverse rods and hold them rigidly in place. The transverse reinforcement may be either individual rods

welded or lapped and wired at the ends for a length of 24 diameters, or it may be wound in helical coils. The latter method is preferred where its use is practicable.

173. *Steel*.—Steel may be made by either the open-hearth or Bessemer process. It shall contain not more than 0.1 per cent phosphorus if made by the Bessemer process and not more than 0.05 per cent if made by the open-hearth process. It shall have an ultimate tensile strength of 55,000 to 70,000 pounds per square inch; an elastic limit not less than 33,000 pounds per square inch; a minimum per cent of elongation in 8 inches of 1,400,000 divided by the ultimate tensile strength; and capability of being bent cold without fracture 180° around a pin having a diameter equal to the thickness of the test piece. Bars or wire will be subject to rejection if the actual weight of any lot varies more than 5 per cent over or under the theoretical weight of that lot.

174. *Concrete*.—Concrete shall be composed of cement, sand and gravel, well mixed and brought to a proper consistency by the addition of water. The proportions will depend upon the nature of component materials and upon the head of water that the pipe will be subjected to, but will vary in general from one part cement to five parts aggregate, to one part cement to six parts of aggregate. The contractor shall not be entitled to any extra compensation by reason of such variations.

175. *Cement*.—Cement for concrete will be furnished to the contractor. The contractor shall give the engineer not less than thirty days' notice in writing of his cement requirements, which shall be stated, so far as practicable in quantities not less than single car lots. The contractor shall return to the railway station at all empty sacks securely bound in bundles in such a manner and of such sizes as the engineer may direct. For all sacks not returned in serviceable condition he will be charged the same amount that the sacks cost The contractor shall provide suitable warehouses for storing the cement and he will be charged at the same price that it cost for all cement wasted and damaged after delivery to him, and also for all unused cement not returned.

176. *Sand*.—Sand for concrete shall be obtained from natural deposits. The particles shall be hard, durable, non-organic rock fragments, such as will pass a ¼-inch mesh screen. The sand must be free from organic matter and must contain not more than 10 per cent of clayey material. The sand must be so graded that, when dry and well shaken its voids will not exceed 35 per cent.

177. *Gravel*.—Gravel for concrete shall consist of hard, durable rock pebbles that will pass through a inch mesh screen and that will be rejected by a ¼-inch mesh screen.

178. *Water*.—The water used in mixing concrete shall be reasonably clean, and free from objectionable quantities of organic matter, alkali salts and other impurities.

179. *Mixing*.—The cement, sand and gravel shall be so mixed and the quantities of water added shall be such as to produce a homogeneous mass of uniform consistency. Dirt and other foreign substances shall be carefully excluded. Machine mixing will be required, and the machine and its operation shall be subject to the approval of the engineer. Enough water shall be used to give the concrete a mushy consistency. If concrete is mixed in freezing weather the sand and gravel or water shall be heated sufficiently before mixing to remove all frost.

180. *Placing*.—No concrete shall be used that has attained its initial set, and

such concrete shall be immediately removed from the site of the work. No concrete shall be placed except in the presence of a duly authorized inspector.

181. *Hauling.*—In handling and hauling the sections of pipe great care shall be taken to avoid injury to the pipe and suitable cradles shall be provided to avoid concentration of the entire weight on small areas. The sections of pipe shall be distributed along the trench as directed by the engineer. Any pipes that are seriously injured in handling or hauling will be rejected and shall be immediately removed from the site of the work or demolished and the contractor shall replace the same with other sections of pipe having the same quantity of reinforcement.

182. *Laying.*—The sections of pipe shall laid be true to line and grade according to stakes established by the engineer and with only sufficient joint space between to allow for satisfactory caulking. Before making the joints the adjacent sections of pipe shall be firmly bedded or supported by blocks to prevent the slightest movement while the joint is being made.

183. *Joints.*—Joints may be made by sectional collars separately moulded and set in grooves in the ends of the pipe sections, or by pouring concrete on the outside of the pipe into suitable flexible forms and at the same time pointing and smoothing off on the inside with a 1 to 1 mixture of mortar. The concrete used for joints shall be equal to or better in quality than that used for the pipe. Each joint shall be reinforced with steel rods, or the equivalent in area of some other form of reinforcement satisfactory to the engineer. As soon as the joint has been made it shall be covered with wet cloths and kept so covered for ten days thereafter. If desired, after the concrete has attained its final set, damp earth may be substituted for the wet cloths.

184. *Tests of Pipe.*—On completion of the work, or as soon as possible thereafter, the contractor shall make a full pressure test of the pipe, water being furnished therefore by All leaks found at the time of the test shall be made tight by the contractor. The cost of making the test, except furnishing water, shall be borne by the contractor.

185. *Measurement.*—The price bid per linear foot shall be for pipe complete in place, ready for service, and shall include all material, except cement, entering into or used on the work, manufacture, hauling, laying, jointing, testing, repairing leaks, etc., until final inspection and acceptance by the engineer. The number of linear feet of pipe in place will be measured along the axis of the pipe after completion.

186. *Payments.*—At the end of each calendar month 60 per cent of the contract price for pipe in place shall be paid to the contractor for all pipe manufactured during that month; 30 per cent additional shall be paid for pipe laid and jointed; and the remainder shall be paid after final test and acceptance of the pipe by the engineer, and when the terms of the contract shall have been fully complied with to the satisfaction of the engineer, and a release of all claims against under, or by virtue of the contract, shall have been executed by the contractor.

METAL FLUMES

187. *Type of Flume.*—All flumes furnished under these specifications shall be made of metal and shall be of the semicircular, smooth-interior type. Bidders

shall submit with their proposals a drawing or catalogue cut showing clearly the type of construction and detailed dimensions of the flume that they propose to furnish. Smoothness of interior surface and ease of erection will be important factors in the consideration of proposals.

188. *Dimensions and Weight of Flume.*—The assembled flume shall have an interior diameter of feet inches and the depth shall be that of the full semicircle. The bidder shall state the weight of the completed flume per linear foot. A complete flume shall consist of sheets carrier rods, compression bars, shoes, nuts and washers.

189. *Thickness of Metal Sheets.*—The thickness of the metal sheets shall be sufficient to provide necessary rigidity and stiffness. The following minimum thicknesses shall be used:

No. of Flume.	U. S. Standard Gage.
24 to 108	20
120 to 156	18
168 to 204	16
216 and larger	14

For the larger sizes of flumes intermediate carrier rods or reinforcing ribs shall be furnished, if necessary, to maintain the true semicircular shape of the sheets when subjected to the full weight of water.

190. *Size of Carrier Rods and Compression Bars.*—Carrier rods shall be designed for a working stress of 8000 pounds per square inch when subjected to the full weight of the water; provided that the smallest allowable carrier rod shall be 3/4-inch in diameter or its equivalent. Carrier rods shall be threaded at both ends and provided with nuts and washers. They shall be stronger in thread than in body. Compression bars shall be equivalent to or larger in cross-section than the corresponding carrier rods. Compression bars shall be provided with shoes for distributing the pressures on supporting timbers. The size and shape of shoes and washers shall be such as to properly distribute the pressures on the wooden timbers supporting the flume, and the average pressure on the timbers due to the full weight of the water in the flume shall not exceed 400 pounds per square inch. All carrier rods, compression bars, shoes, nuts and washers shall be coated before shipment by being dipped when hot in a mixture of pure California asphalt, or its equivalent; not less than 7 per cent nor more than 10 per cent of pure linseed oil shall be mixed with the asphalt. Materials for coating shall be subject to the approval of the engineer.

191. *Joints.*—The joints between successive sheets comprising the flume lining shall be designed to be rigid and water tight and shall offer the least possible obstruction to the flow of water through the flume. All necessary crimping of sheets to form the joints shall be done by the contractor.

192. *Curves.*—The metal sheets for curved flumes shall be fabricated so as to conform exactly to the degree of curvature required. The engineer will furnish the contractor a list of lengths of flumes required of each degree of curvature and the degree of curvature shall be plainly stamped on each sheet.

193. *Materials for Sheets.*—The metal sheets shall be manufactured from steel and shall be galvanized. The chemical and physical properties shall be as follows:

Elements Considered.	Open-hearth Steel.	Bessemer Steel.
Carbon max. per cent.	0.07-0.14	0.07-0.14
Manganese, per cent.	0.34-0.46	1.00
Phosphorus, per cent.03	.10
Sulphur, per cent.05	.07
Silicon, per cent.02	.02
Copper, per cent.	Recorded	Recorded
Ultimate strength.	50,000-60,000	50,000-60,000
Elastic limit.	25,000-35,000	25,000-35,000
Minimum elongation in 8 inches.	25 per cent	25 per cent

The material shall show homogeneity of structure as exhibited by the ends of the broken test specimens.

194. *Material for Compression Bands and Carrier Rods.*—These shall be made of medium steel and shall have an ultimate tensile strength of 55,000 to 65,000 pounds per square inch; an elastic limit of not less than one-half the ultimate tensile strength; a minimum per cent of elongation in 8 inches of 1,400,000 divided by the ultimate tensile strength; a silky fracture; and capability of being bent cold, without fracture, 180 degrees around a pin having a diameter equal to the thickness of the test piece.

195. *Material for Shoes and Washers.*—The bearing shoes and washers for compression bands and carrier rods may be made of either gray or malleable cast iron. Gray iron castings shall conform in all respects to the standard specifications for such castings adopted September 1, 1905, by the American Society for Testing Materials, except that no tensile test will be required. Malleable iron castings shall conform to the standard specifications for such castings adopted November 15, 1904, by the American Society for Testing Materials.

196. *Test Pieces.*—All test pieces shall be furnished by the contractor at his expense. The number and shape of test specimens for gray and malleable castings shall be as prescribed in the specifications of the American Society for Testing Materials specified in paragraph hereof. For all other materials at least one test specimen shall be taken from each melt and where possible shall be cut from the finished material. Specimens not cut from finished material shall, in so far as possible, receive the same treatment before testing as the finished product. Tensile test pieces shall be $\frac{3}{4}$ inch in diameter and shall have 8 inches of gage length.

197. *Inspection and Tests.*—All necessary facilities and assistance for making inspection and tests shall be furnished to the engineer by the contractor at the expense of the contractor. Physical tests and chemical analysis will be made by at his own expense; or they may be made at the factory by the contractor or his employees, acting under the direction of the engineer or his representative; or certified tests may, at the option of the engineer, be accepted in lieu of the above-mentioned tests. No material shall be shipped until all tests and final inspection have been made, or certified tests shall have been accepted.

198. *Galvanizing.*—The metal sheets shall have a coating of tight galvanizing. The grooving for joints and bending of sheets shall be done in such a manner as to avoid any injury to galvanizing. All sheets on which the galvanizing is cracked or otherwise injured will be rejected. The galvanizing shall consist of a coating of pure zinc evenly and uniformly applied in such a manner that it will adhere

firmly to the surface of the metal. Each square foot of metal sheets shall hold not less than 2 ounces of zinc. The galvanizing shall be of such quality that clean, dry samples of the galvanized metal shall appear black and show no copper-colored spots when they are four times alternately immersed for one minute in the standard copper sulphate solution and then immediately washed in water and thoroughly dried. The coating shall fully and completely cover all surfaces of the material, and shall appear smooth and polished and be free from lumps of zinc.

199. *Measurement and Payment.*—Payment will be made on the basis of the actual assembled length of flume measured along the center line and at the prices bid in the schedule. per cent of the contract price of each shipment will be paid on the acceptance of the material by the inspector and receipt by the engineer at of the bill of lading, properly receipted; and the remainder shall be paid when all the material covered by the contract shall have been received at its destination and finally inspected, checked and accepted by the engineer, and the terms of the contract shall have been fully complied with to the satisfaction of the engineer.

STEEL HIGHWAY BRIDGES

200. *Description.*—The bridge shall be of the $\left\{ \begin{array}{l} \text{riveted} \\ \text{pin-connected} \end{array} \right\} \left\{ \begin{array}{l} \text{deck} \\ \text{through} \end{array} \right\}$ truss type, having a span, center to center of end bearings, of feet inches, and a clear width between trusses of feet. The bridge shall consist of spans.

201. *Stress Sheets and Loading.*—The bidder shall furnish with his bid a stress sheet showing the maximum stress to which members are to be subjected, based on the following loading:

l = span in feet;

w = weight of steel per square foot of floor;

p = live load per square foot of floor.

Dead load:

w = not less than the actual weight of steel.

Wooden floor = 15 pounds per square foot.

Live load:

$p = 100 - \frac{1}{10}$ or a concentrated load of 30,000 pounds on two axles 8 feet center to center with wheels spaced 6 feet center to center, and two-thirds of the load on one axle, assumed to occupy a space 16 feet in the direction of traffic by 12 feet at right angles thereto.

Impact: for chords 25 per cent of uniform live load.

for web and floor, 40 per cent of either uniform or concentrated live load.

Wind load: unloaded chord, 100 pounds per linear foot of bridge.

loaded chord, 200 pounds per linear foot of bridge.

NOTE.—Neither wind nor concentrated loads are assumed to act simultaneously with uniform live load.

202. *Detail Drawings.*—The contractor shall prepare all detail and shop drawings. Each proposal shall be accompanied, in addition to the stress sheets, by such general drawings of members and details as will clearly show the type of construction proposed at all points, and all items that are necessary to enable the engineer

to determine the strength of all parts of the structure and whether, as a whole and in all its parts, it complies with these specifications. As soon as practicable after the award of the contract complete detail and shop drawings shall be furnished to the engineer by the contractor and these shall receive the approval of the engineer before work is commenced. Working drawings shall be furnished in triplicate. The approval of general and working drawings shall not relieve the contractor from the responsibility for any errors therein. In case the engineer requires additional copies of drawings for use during construction or for record these shall be furnished by the contractor without charge.

203. *Unit Stresses.*—The following limiting working stresses in pounds per square inch of net cross-section shall be used:

Tension on rolled sections.....	16,000
Shear on rolled sections.....	9,000
Bearing on pins.....	20,000
Shear on pins.....	10,000
Bearing on shop rivets.....	20,000
Shear on shop rivets.....	10,000
Bearing on field rivets.....	15,000
Shear on field rivets.....	7,500
Bearing on columns.....	$16,000 - 70 \frac{L}{R}$
Bearing on expansion rollers per linear inch.....	500 <i>d</i>

d = diameter of roller in inches;

L = unsupported length of column in inches;

R = least radius of gyration in inches.

No compression member shall have an unsupported length exceeding 120 times its least radius of gyration for main members, or 140 times its least radius of gyration for laterals.

204. *Reversed Stresses.*—Members subject to reversion of stresses shall be designed to resist both tension and compression and each stress shall be increased by eight-tenths of the smaller stress for determining the sectional area. The connections shall be designed for the arithmetical sum of the stresses.

205. *Combined Stresses.*—Members subject to both direct and bending stresses shall be designed so that the greatest unit fibre stress shall not exceed the allowable unit stress for the member.

206. *Net Sections.*—The net section of any tension flange or member shall be determined by a plane cutting the member square across at any point. The greatest number of rivet holes that can be cut by any such plane, or whose centers come nearer than $2\frac{1}{2}$ inches to said plane, are to be deducted from the cross-section when computing the net area.

207. *Minimum Sizes.*—No metal less than $\frac{1}{8}$ inch in thickness shall be used except for filling plates. The smallest angles used shall not be less than $2\frac{1}{2} \times 2\frac{1}{2} \times \frac{1}{8}$ inches. A single angle shall never be used for a compression member.

208. *Connections.*—All connections shall be designed to develop the full strength of the members. Connecting plates shall be used for connecting all members and in no case shall any two members be connected directly by their flanges. Angles

subject to tensile stress shall be connected by both legs, otherwise only the section of the leg actually connected will be considered effective.

209. *Portal Bracing.*—Portal bracing shall consist of straight members and shall be designed to transmit the full wind reaction from the upper lateral system into the end posts and abutments. The clear head room below portal and sway bracing for a width of 6 feet on either side of center line shall be not less than 15 feet.

210. *Sway Bracing.*—Sway bracing of an approved type shall be provided at each panel point.

211. *Lateral Systems.*—Upper and lower lateral systems shall be designed to resist the maximum wind pressures from either direction. The members shall be nearly as practicable in the plane of the axes of the chords.

212. *Floor System.*—All floor beams and stringers shall be rolled or riveted steel girders. Floor beams shall be rigidly connected to the trusses, and stringers shall be rigidly connected to the floor beams and their tops shall be flush with the tops of floor beams.

213. *Intersection of Axes of Members.*—The axes of all members of trusses, and those of lateral systems coming together at any apex of a truss or girder must intersect at a point whenever such an arrangement is practicable, otherwise all induced stresses and bend of members caused by the eccentricity must be provided for.

214. *Batten Plates and Lattice Bars.*—The open sides of compression members shall be stayed by batten plates at the ends and by diagonal lattice bars at intermediate points. Batten plates shall be used at intermediate points when, for any reason, the latticing is interrupted. Lattice bars shall be inclined to the member not less than 60 degrees for single latticing not less than 45 degrees for double latticing.

215. *Eyebars.*—The thickness of eyebars shall be not less than $\frac{3}{8}$ inch nor less than one-seventh the width of the bar. Heads of eyebars shall be formed by upsetting and forging and shall be so proportioned as to develop the full strength of the bar. Eyebars shall be perfectly straight at the time they are bored, and all bars composing one member shall be piled, clamped together, and bored in one operation. The eyebars composing a member shall be so arranged that their surfaces are not in contact.

216. *Rods.*—No rod shall be used which has a cross-sectional area less than $\frac{3}{4}$ square inch. Screw-ends shall be stronger in thread than in body.

217. *Riveting.*—The rivets used shall in general be $\frac{3}{4}$ inch in diameter; smaller ones being allowable where made necessary by the size of the member, but no rivets smaller than $\frac{3}{8}$ inch in diameter shall be used in legs of an angle iron equal to or greater than $3\frac{1}{2}$ inches wide. Not less than three rivets shall be used in any main truss, portal or lower lateral connection or in any compression strut or sway bracing, portal bracing or upper lateral system connection. The pitch of rivets in all classes of work in the direction of the stress shall never exceed 6 inches nor be less than three diameters of the rivet. At the ends of compression members it shall not exceed four times the diameter of the rivets for a length equal to twice the width of the member. No rivet hole center shall be less than one and one-half diameters from the edge of the plate, and whenever practicable this distance is to be increased to two diameters. The rivets when driven must completely fill the holes. The rivet heads must be round, and they must be of uniform size

for the same size rivets throughout the work; they must be neatly made and concentric with the rivets and must thoroughly pinch the connected pieces together. Whenever possible all rivets shall be machine driven. No rivet excepting those in shoe plates and roller and bed plates is to have a less diameter than the thickness of the thickest plate through which it passes. The effective diameter of any rivet shall be assumed the same as its diameter before driving, but in making deductions for rivet holes in tension members the diameter of the hole shall be assumed $\frac{1}{8}$ inch larger than that of the rivet. The amount of field riveting shall be reduced to a minimum, and all details are to be made so that the field rivets can be driven readily. Rivets shall not be used in direct tension. The contractor will be held responsible for the correct fitting of all parts upon assembly in the field, and, if necessary, to insure this, all members shall be assembled in the shop, and fitted before shipment.

218. *Pins.*—All pins shall be turned smoothly to a gage and shall be finished perfectly round, smooth and straight. All pins up to and including $3\frac{1}{2}$ inches in diameter shall fit the pin-holes within $\frac{1}{16}$ inch, all pins over $3\frac{1}{2}$ inches in diameter shall fit their holes within $\frac{1}{8}$ inch. The contractor must provide steel-pilot nuts for all pins to preserve the threads while the pins are being driven.

219. *Camber.*—All trusses shall be cambered by making the top chord section longer than the corresponding bottom chord section by $\frac{1}{8}$ inch for each 10 feet of length.

220. *Expansion and Contraction.*—Provision shall be made for changes in length due to temperature variations of at least $\frac{1}{8}$ inch for each 10 feet of span.

221. *Roller Ends.*—Each truss of more than 60 feet span shall be provided with one roller end. For spans 60 feet and less a sliding end may be used. Rollers shall be turned accurately to gage and must be finished perfectly round and to the correct diameter or diameters from end to end. The tongues and grooves in plates and rollers must fit snugly so as to prevent lateral motion. Roller beds must be planed. The smallest allowable diameter of expansion rollers is $3\frac{1}{2}$ inches.

222. *Anchorages.*—Every span must be anchored at each end to the pier or abutment in such a manner as to prevent lateral motion, but so as not to interfere with the longitudinal motion of the truss due to changes of temperature. The shoes or bolsters shall be so located that the anchor bolts will occupy a central position in the slotted holes at a temperature of 40° F. Bedplates shall be designed to distribute the load over a sufficient area to keep the pressure on the masonry below 400 pounds per square inch.

223. *Hand Railing.*—A suitable latticed hand railing shall be provided for each truss.

224. *Shop Painting.*—Before leaving the shop all structural steel, except as below specified, shall be thoroughly cleaned of all loose scales and rust and given one coat of good iron ore paint mixed with pure linseed oil, which shall be well worked into all joints and open spaces. All surfaces of steel that will come in contact with each other shall be painted before being riveted or bolted together. Pins, pinholes, screw threads and all finished surfaces shall not be painted but shall be coated with white lead and tallow as soon as they are finished.

MATERIAL

225. *Manufacture.*—Structural steel shall be made by the open-hearth process and shall conform in all respects, not specifically mentioned herein, to the Standard Specifications for Structural Steel for Bridges of the American Society for Testing Materials adopted August 25, 1913.

226. *Physical and Chemical Properties of Structural Steel.*—Steel shall contain not more than 0.05 per cent sulphur, and not more than 0.04 per cent phosphorus for basic open-hearth nor more than 0.06 per cent phosphorus for acid open-hearth. It shall have an ultimate tensile strength of 55,000 to 65,000 pounds per square inch; an elastic limit, as indicated by the drop of beam of not less than one-half the ultimate tensile strength; a minimum per cent of elongation in 8 inches of 1,500,000 divided by the ultimate tensile strength; a silky fracture and capability of being bent cold without fracture 180 degrees flat on itself for material $\frac{3}{4}$ inch thick and under; for material over $\frac{3}{4}$ inch to and including $1\frac{1}{4}$ inches around a pin having a diameter equal to the thickness of the test piece; and for material over $1\frac{1}{4}$ inches thick, around a pin having a diameter equal to twice the thickness of the test piece. A deduction of 2.5 will be allowed in the specified percentage of elongation for each $\frac{1}{8}$ inch in thickness below $\frac{1}{4}$ inch and a deduction of 1 will be allowed for each $\frac{1}{8}$ inch in thickness above $\frac{1}{4}$ inch.

227. *Physical and Chemical Properties of Rivet Steel.*—Rivet steel shall contain not more than 0.04 per cent, each of sulphur and phosphorus. It shall have an ultimate tensile strength of 45,000 to 55,000 pounds per square inch; an elastic limit as determined by the drop of beam of not less than one-half the ultimate tensile strength; a minimum per cent of elongation in 8 inches of 1,500,000 divided by the ultimate tensile strength; a silky fracture; and capability of being bent cold without fracture 180 degrees flat on itself.

228. *Finish.*—Finished material must be free from injurious seams, flaws, or cracks, and have a workmanlike finish.

229. *Marking.*—Every finished piece of steel shall have the melt number stamped or rolled upon it. Steel for pins and rollers shall be stamped on the end. Rivet steel and other small parts may be bundled, with the above marks on an attached metal tag.

230. *Test Pieces.*—(See paragraph 40.)

231. *Tests.*—(See paragraph 41.)

232. *Payment for Fabricated Material.*—..... per cent of the contract price of each shipment will be paid on the acceptance of the material by the inspector and receipt by the engineer of the bill of lading, properly receipted (and the remainder will be paid when all of the material covered by the contract shall have been received at its destination and finally inspected, checked and accepted by the engineer, and the terms of the contract shall have been fully complied with to the satisfaction of the engineer).

(NOTE.—Portion in parentheses is to be omitted here when erection is included in the contract.)

ERECTION

233. *Material and Labor.*—The contractor shall furnish all labor, tools, machinery and materials, except wood flooring, for erecting the bridge complete in place,

including all hauling, erection and dismantling of all falsework and staging, setting of anchor bolts, and all other work necessary for the completion of the structure ready for traffic.

234. *Wood Floor.*—Lumber for flooring will be furnished by, but shall be put in place by the contractor and he shall furnish all necessary fastenings. The lumber will be delivered to the contractor at the railroad station most convenient to the work and the contractor shall haul same to the bridge site.

235. *Painting after Erection.*—After erection all metal work shall be thoroughly cleaned of mud, grease and other objectionable matter and evenly painted with two coats of paint of the kind and colors specified by the engineer. Linseed oil shall be used as the vehicle in mixing the paint for each of these coats and the separate coats shall have distinctively different shades of color. All recesses which might retain water shall be filled with thick paint or some waterproof material before final painting. The first coat shall be allowed to become thoroughly dry before the second coat is applied. No painting shall be done in wet or freezing weather.

236. *Final Payment.*—Final payment will be made upon completion of the erection and acceptance of the finished structure by the engineer, and when the terms of the contract shall have been fully complied with to the satisfaction of the engineer.

TUNNELS

237. *Excavation.*—The tunnel, shafts and adits shall in all cases be excavated in such manner and to such dimensions as will give suitable room for the necessary timbering, lining, ventilating, pumping and draining. The contractor shall use every reasonable precaution to avoid excavating beyond the outside lines of permanent timbering and beyond the outside neat concrete lines where no permanent timbering is required. All drilling and blasting shall be carefully and skillfully done so as not to shatter the material outside of the required lines. Any blasting that would probably injure the work will not be permitted and any damage done to the work by blasting shall be repaired by the contractor at his expense, and in a manner satisfactory to the engineer. Tunnel excavation will be paid for at the price bid per linear foot. Partial excavation, as in the case of a heading, amounting to not less than one-half the full section will be allowed for in the monthly progress estimates at one-fourth of the price named in the contract for full excavation.

238. *Timbering.*—Suitable timbering and lagging shall be used to support the tunnel, sides and roof wherever necessary. If practicable, this timbering may be removed before the construction of the concrete lining. Timbering may be left in place, provided it is constructed in such a manner as not to weaken the concrete lining and is in accordance with designs approved by the engineer. An approved design for such permanent timbering is shown in the drawings but, in case this design is found to be inadequate it may be modified from time to time, subject to the approval of the engineer. Lumber for timbering shall be furnished by the contractor. The cost of furnishing and placing permanent and temporary timbering shall be included in the price per linear foot bid in the schedule for excavating the tunnel, except that in addition thereto the contractor will be paid the sum of dollars per M feet B. M. for permanent timbering in place. No payment will

be made for temporary timbering nor for timber used in filling cavities. In measuring permanent timbering for payment, the net length of pieces and the commercial cross-sectional dimensions will be taken. Nothing herein contained shall prevent the contractor from placing such temporary timbering as he may deem necessary nor from using heavier permanent timbering than that shown in the drawings, nor shall be construed to relieve the contractor from sole and full responsibility for the safety of the tunnel and for damage to person and property.

239. *Concrete Lining.*—The tunnel shall be lined throughout with concrete. The tunnel lining side walls and arch, where permanent timbering is not required, shall have an average thickness of inches, with a minimum thickness of inches over projecting points of rock. The average thickness of the concrete tunnel invert shall be inches. Where permanent timber is required it shall be set back so far that the concrete lining will cover the timber at least inches. The concrete for such timber portions of the tunnel will be estimated as having an average thickness of inches. If the tunnel is excavated to greater dimensions than necessary for placing the prescribed average thickness of the concrete lining, the excess space shall be solidly filled with concrete, or the lining shall be confined with forms to the prescribed thickness and properly back-filled. Concrete tunnel lining will be paid for by the cubic yard at the unit price named in the contract, measured to the neat lines shown in the drawings, based on the average thickness herein specified.

240. *Lines and Grades.*—The contractor shall provide such forms, spikes, nails, troughs for plumb-bob lines, light, etc., and such assistance as may be required by the engineer in giving lines and grades, and the engineer's marks shall be carefully preserved. Work in the shafts, adits and tunnel shall be suspended for such reasonable time as the engineer may require to transfer lines and to mark points for line and grade. No allowance will be made to the contractor for loss of time on account of such suspension.

241. *Draining.*—The contractor shall drain the tunnels and adits where necessary to rid the same of standing water. Pumping shall be done where gravity flow to an outlet can not be secured.

242. *Lighting and Ventilating.*—The contractor shall properly light and ventilate the tunnel during construction.

243. *Storage and Care of Explosives.*—Caps or other exploders or fuses shall in no case be stored or kept in the same place in which dynamite or other explosives are stored. The location and design of powder magazines, methods of transporting explosives and in general the precautions taken to prevent accidents must be satisfactory to the engineer; but the contractor shall be liable for all damages to person or property caused by blasts or explosions.

244. *Backfilling.*—Any space outside of the concrete tunnel lining shall be compactly refilled at the expense of the contractor with such of the excavated material from the tunnel as may be approved by the engineer. Large cavities in the tunnel roof may be filled with waste timber. The backfilling to the springing lines of the arch shall be placed before the arch is constructed, and shall be brought up evenly on both sides of the tunnel; it shall be spread in layers not exceeding 6 inches in thickness and well rammed. The invert and side walls shall be braced, if required, during the placing of the back-filling.

245. *Adits and Shafts.*—The contractor shall construct at his own expense such

adits and shafts as he may desire to use to expedite the tunnel work. The sides and the arch of the tunnel lining situated immediately beneath the opening of each shaft shall be increased to such suitable thicknesses as the engineer may prescribe; and each adit shall be closed at the point where it meets the tunnel with a block of concrete averaging at least 4 feet in thickness, extending into the sides of the adit 2 feet and having a foundation 2 feet below the bottom of the tunnel. All concrete required for this purpose shall be furnished by the contractor at his own expense, the cement for which will be furnished to the contractor at its cost on the work. All shafts must be compactly refilled. Dumping from the top will not be allowed until the tunnel arch has been covered to a depth of at least 10 feet. After the completion of the block of concrete required for closing an adit the adit shall be refilled and the filling tamped into place for a distance of 20 feet from the tunnel.

TELEPHONE SYSTEM

NOTE.—For short telephone lines serving a small number of stations a ground return circuit will in general give satisfactory service. For long lines or those having many stations a metallic circuit will be preferable. In determining whether to use the ground circuit or metallic circuit the engineer should carefully study the importance of continuity of service, the length of line and number of stations, the liability of disturbance by existing or contemplated electrical systems and other local conditions. For the usual telephone systems No. 12 wire will be amply large, but for lines subjected to exceptionally heavy loads of sleet and snow the use of No. 10 wire may be necessary.

246. *Pole Line.*—The pole line will follow tangents and curves as shown in the drawings and will have the number of corners therein shown. An average of thirty poles per mile shall be used on tangents. The spans adjoining a pole on a curve at a corner shall not exceed 150 feet each for a pull of 5 feet, and the allowable length span shall decrease 10 feet for each increase of 5 feet in the pull up to and including a pull of 30 feet. When a bend made on a single pole produces a pull of more than 30 feet the pole shall be thoroughly braced or guyed and the adjoining spans shall not exceed 100 feet each, or such a bend shall be made on two poles and the lengths of the adjoining spans adjusted with the foregoing provisions relating to span and pull. The term "pull" as herein used means the perpendicular distance from the pole under consideration to a straight line joining the two adjacent poles. When a span of from 200 to 250 feet is necessary, the adjoining spans shall not exceed 100 feet each, and where a span of from 250 to 500 feet is necessary, the adjoining two spans at each end shall not exceed 100 feet each. On uneven ground the spans shall be so chosen and the poles so set as to avoid abrupt changes in the direction of the wire line vertically. In distributing poles, the heaviest shall be placed so far as practicable on corners and at the ends of long spans.

247. *Poles.*—Telephone poles shall be in general 5-inch poles 25 feet in length. At crossings of highways, railroads and gullies 6-inch poles of requisite length shall be used, and for this purpose poles 30 feet in length and poles 35 feet in length will be required. The poles shall be cut from growing trees, shall be reasonably well proportioned for their length and shall be peeled, neatly trimmed, well seasoned, reasonably sound and free from unsightly wind twists, injurious butt rot and other defects that materially impair them for the use intended. Butt rot in the center, including small ring rot outside of the center, the total of

which does not exceed 10 per cent of the area of the butt, will be permitted. Sweeps not exceeding 1 inch for every 5 feet in length of pole will be permitted. The tops of seasoned 5-inch poles shall measure not less than 15 inches in circumference and those of 6-inch poles not less than 18 inches. If the poles are measured when green 5-inch poles shall be not less than 16 inches in circumference at the tops and 6-inch poles not less than 19½ inches. The top of each pole shall be trimmed so as to form a right-angled roof. The roofs of poles shall be painted with two coats of good quality of iron oxid paint.

248. *Setting Poles.*—On tangents the poles shall be set in a vertical position, and on curves and at corners they shall be raked 10 inches for a pull less than 5 feet, 15 inches for a pull of from 5 to 10 feet and 25 inches for a pull of more than 10 feet. Each pole hole in earth shall be 5 feet in depth and shall be dug of sufficient size throughout to admit of tamping around the entire perimeter of the pole. On hillsides the depth of the holes shall be measured from the lowest side of the opening. Where the line crosses solid rock, pole holes shall be blasted to a depth of 3 feet, unless such solid rock can be covered by a single span not exceeding 250 feet. Each pole shall be carefully held in proper position while the hole is being filled. Filling holes with earth shall be done by one man and the earth firmly tamped simultaneously by three men. Rock debris when used for filling holes shall contain sufficient earth to fill all cavities therein and shall be homogeneously placed and thoroughly compacted. When the hole is filled, earth or rock shall be piled and firmly packed about the hole to a height of 1 foot above the original ground surface. The filling for holes and the general manner of setting poles shall be such as will enable each pole to withstand the strains to which it will be subjected.

249. *Braces.*—Braces shall be 5 inches in diameter at the top, shall be long enough to attach to the pole at two-thirds the height thereof above the ground, to make an angle of 30 degrees therewith and to extend into the ground at least 4 feet measured along the brace and shall conform in all other respects to the specifications for poles braces feet in length, braces feet in length and braces feet in length will be required:

250. *Setting Braces.*—Each brace shall be set in the ground at least 3½ feet in vertical depth. The brace shall be cut slanting at the top to fit close to the pole and shall be attached to the pole with a ½-inch bolt supplied with a washer at each end. This bolt shall be placed at the lowest point of the joint. In fitting the brace to the pole all trimming shall be done on the brace.

251. *Guys and Anchors.*—Guys shall consist of No. 6, B.W.G., galvanized steel wire. Guy anchors in earth shall consist of and galvanized iron rods. (If cast-iron anchor plates are used they shall be 8 inches square and ½ inch thick and shall be provided on the lower face with a cylindrical lug at the center having a diameter of 2 inches, and a height of 1½ inches and with diagonal ribs ½ inch thick rising from zero elevation at the corners and terminating in the cylindrical lug with elevation equal thereto. Each cast-iron plate shall have a ¾-inch cored hole through its center for the reception of the anchor rod.) Each galvanized iron rod shall be ½ inch in diameter and 6 feet in length and shall be provided at the upper end with a suitable eye and a wire rope thimble for a ½-inch rope and at the lower end with U. S. standard threads and a galvanized iron nut. Guy anchors in rock shall consist of galvanized iron rods of the combination eye and wedge-bolt

type 1 inch in diameter and 18 inches in length, each provided with a suitable wedge and a wire rope thimble for a $\frac{1}{4}$ -inch rope.

252. *Placing Guys and Anchors.*—Each guy shall be attached to the pole immediately below the bracket by making two turns around the pole and wrapping the end eight times around the guy and shall be secured to its rod by passing around the thimble and terminating on itself in eight turns. The turns about the pole shall be secured by at least three 2-inch galvanized iron staples. The angle between the guy and its pole shall be as nearly 45 degrees as is practicable.

253. *Guying and Bracing.*—Guys and braces shall be placed wherever considered essential by the engineer. On tangents and on curves having pulls less than 10 feet double side guys will be required about every 1000 feet of line; and on curves or at corners where the pull is from 10 to 30 feet each pole shall be provided with a guy or brace. On curves and at corners each pole at which the pull exceeds 30 feet shall be provided with either a guy or a brace placed in the plane of each of the adjoining spans and the adjacent poles shall be provided with appropriate supplemental bracing or guying. At least one head and one back guy shall be installed on every mile of line. Additional head and back guys or braces shall be used wherever the slope of the ground, length of span, change in direction or extra pole height at road crossings requires them for stability.

254. *Brackets (Ground Circuit).*—Pony telephone side brackets $1\frac{1}{2} \times 2 \times 10$ inches shall be used. They shall be made of the best quality of well-seasoned, sound, straight-grained oak, free from knots and sapwood, shall have the insulator threads truly cut and complete and shall be painted with two coats of the best quality of iron oxid paint. Each bracket shall be securely fastened to the pole with one 40d and one 60d galvanized wire nail in such a position that the base of the bracket will be about 14 inches below the top of the pole. Where the change in direction of the wire at any pole is more than 60 degrees an extra bracket shall be used. Brackets shall be placed on the same side of all poles except on curves or at corners, where they shall be so placed that the strains produced by the wires will tend to press the insulators toward the poles.

255. *Brackets (Metallic Circuit).*—Pony telephone side brackets $1\frac{1}{2} \times 2 \times 10$ inches shall be used. They shall be made of the best quality of well-seasoned, sound, straight-grained oak, free from knots and sapwood, shall have the insulator threads truly cut and complete and shall be painted with two coats of the best quality of iron oxid paint. Each bracket shall be securely fastened to the pole with one 40d and one 60d galvanized wire nail. Where the change in direction of the wire at any pole is more than 60 degrees an extra bracket shall be used for each wire. On tangents the brackets shall be placed one on each side of the pole and on curves and corners they shall be so placed that the strains produced by the wires will tend to press the insulators toward the poles. The top bracket shall be so placed that its base will be about 14 inches below the top of the pole, and the bottom bracket so that its base will be 12 inches below that of the top bracket, except on transposition poles on tangents. On transposition poles the brackets shall be at the same elevation so placed that the insulator for each wire will be as nearly as practicable on a straight line between those for the same wire on the adjacent poles.

256. *Insulators (Ground Circuit).*—Standard pony, glass, 10-ounce insulators shall be used. They shall be made of common glass, shall be free from cracks.

blow-holes, flaws and sharp edges and shall have smooth threads of uniform pitch accurately fitting the threads on the brackets.

257. *Insulators (Metallic Circuit).*—Standard pony, glass, 10-ounce insulators and two-piece transposition insulators of equivalent strength shall be used. They shall be made of common glass, shall be free from cracks, blow-holes, flaws and sharp edges and shall have smooth threads of uniform pitch accurately fitting the threads on the brackets.

258. *Line Wire.*—The line wire shall consist of No. 12, B.W.G., galvanized iron wire of the quality known as "Best Best," having an average resistance at 68° F. not to exceed $34\frac{1}{2}$ ohms per mile. The wire shall be of uniform cross-section, shall weigh approximately 170 pounds per mile, shall have an ultimate tensile strength of not less than 560 pounds and shall be capable of withstanding at least fifteen twists about its axis in a length of 6 inches. It shall be soft and pliable and capable of elongating 15 per cent without breaking, after being galvanized. The diameter of the line wire in inches shall be not more than 0.113 nor less than 0.106. The wire shall be furnished in coils of $\frac{1}{2}$ mile or 1 mile continuous lengths, without welds, joints or splices, and each coil shall be drawn from a rod without welds, joints or splices of any kind. The galvanizing shall consist of a coating of pure zinc evenly and uniformly applied in such a manner that it will adhere firmly to the surface of the metal. The galvanizing shall be of such quality that clean dry samples of the galvanized wire shall appear black and show no copper-colored spots after they have been four times alternately immersed for one minute in the standard copper sulphate solution and then immediately washed in water and thoroughly dried.

259. *Stringing Wire.*—The wire shall be strung with as few joints as possible and shall be joined by twisting the wires for a distance of about 3 inches around each other two complete turns and soldering, the end of each wire terminating in five tightly fitting contiguous turns around the other wire. The line wire shall be tied to the insulators with tie wires of No. 12, B.W.G., galvanized iron wire cut in suitable lengths. The line wire shall first be laid in the groove of the insulator on the side away from the pole, after which the tie wire shall be passed entirely around the insulator and line wire and terminate at each end in five tightly fitting turns around the line wire. The tension on the line wire for each span shall be, in the judgment of the engineer, as high as will be safe for the minimum temperature for the locality.

260. *Transposition (Metallic Circuit).*—In general a transposition of the line wires shall be made once in each mile, but the exact number and location of transpositions shall conform to the local requirements therefor. Each transposition shall be made without the use of transposition insulators by interchanging the wires laterally in one span and vertically in the two succeeding spans.

261. *Trimming Trees.*—All trees along the line of such character and location as to render them liable to being blown over so as to interfere with the telephone wires shall be cut down and removed or burned, and all trees close to the line that in the judgment of the engineer will not endanger the telephone wires shall be so trimmed as to leave a clear space of 10 feet about the telephone wires in all directions under stress of the heaviest probable wind storms.

262. *Lightning Rods.*—Lightning rods consisting of No. 12, B.W.G., galvanized iron wire shall be installed throughout the line at intervals of about $\frac{1}{2}$ mile. Each

rod shall be located about one-fourth the distance around the pole from the bracket and shall be attached to the pole with 2-inch galvanized iron staples. The upper end of each rod shall project about 3 inches above the top of the pole and the lower end shall terminate beneath the butt of the pole in a flat coil containing about 6 feet of wire.

263. *Lightning Arresters.*—A lightning arrester shall be installed on each line pole at which the current is transferred from the line wire to a station wire. The arrester shall be of the double-pole, lightning and sneak-current type, shall have adjustable and removable carbon blocks mounted upon porcelain bases and shall have fuses that will adequately protect it from lightning and sneak currents. The arrester shall be connected with No. 12, B.W.G., galvanized iron wire to any existing water pipe system nearby or to a galvanized iron ground rod $\frac{1}{2}$ inch in diameter and 6 feet in length driven into permanently moist earth. The connecting wire shall be carefully soldered to the water pipe or to the ground rod. Twenty-five extra sets of fuses shall be furnished with each arrester.

264. *Station Wiring (Ground Circuit).*—The current shall be carried into buildings on No. 18, B. & S. G., rubber-insulated copper wire covered with black braid saturated with waterproof compound and carried on porcelain knobs having a diameter of not less than $1\frac{1}{2}$ inches. The return pole of each instrument shall be connected by means of a similar wire to any existing water pipe system nearby or to a galvanized iron ground rod $\frac{1}{2}$ inch in diameter and 6 feet in length driven into permanently moist earth. The connecting wire shall be carefully soldered to the water pipe or to the ground rod. Inside wiring shall consist of No. 18, B. & S. G., rubber-insulated copper wire covered with braid of a greenish color. All inside wiring shall conform to the best practice and shall be done only by expert electricians. Where wires pass through walls and partitions insulated bushing shall be provided.

265. *Station Wiring (Metallic Circuit).*—The current shall be carried into and out of buildings on No. 18, B. & S. G., rubber-insulated copper wire covered with black braid saturated with weatherproof compound and carried on porcelain knobs having a diameter of not less than $1\frac{1}{2}$ inches. Inside wiring shall consist of No. 18, B. & S. G., rubber-insulated copper wire covered with braid of a greenish color. All inside wiring shall conform to the best practice and shall be done only by expert electricians. Where wires pass through walls and partitions insulated bushings shall be provided.

266. *Instruments.*—Each proposal shall be accompanied by a complete description of the various essential parts of the telephone that the bidder proposes to furnish, which shall be subject to the approval of the engineer.

VITRIFIED PIPE, FOR CULVERTS

267. *Quality.*—All vitrified pipe shall be of the best quality of smooth, well burned, salt-glazed, vitrified clay sewer pipe. It shall be of the hub-and-spigot pattern free from cracks due to rough handling, cooling, frost and other causes and free from chippings and clear fractures that will impair it for the purpose intended. All pipes that are designed to be straight shall not deviate materially from a straight line, and those designed to be curved shall substantially conform to the required radius of curvature and other general dimensions.

268. *Size.*—Both the bodies and bells of all pipes shall have a thickness not less than one-twelfth the inside diameter of the pipe. Each hub shall freely receive to its full depth the spigot end of the succeeding pipe without any chipping of either and leave a space of not less than $\frac{1}{2}$ inch all around for the cement joint; it shall also have a depth from its face to the shoulder of the pipe on which it is moulded at least 2 inches greater than the thickness of said pipe. The length of pipe sections shall be between 2 and 3 feet exclusive of the socket.

269. *Rejection.*—Any pipe that does not meet the above requirements will be rejected.

CHAPTER XXIII

TABLES

TABLE XLIII.—EXTREME FLOOD DISCHARGES

Stream	Locality	Drainage Area, in Sq. Miles	Maximum Discharge in Cu.ft. per Sec. per Sq. Mile	Date of Flood
I. AMERICAN STREAMS:				
Columbia River.....	Dalles, Ore.....	237,000	5.9	
Ohio River.....	Paducah, Ky.....	205,750	7.0	Feb., 1884
Susquehanna.....	Harrisburg, Pa.....	24,030	30.6	Mar., 1865
Susquehanna.....	Harrisburg, Pa.....	24,030	30.	June, 1889
Tennessee.....	Chattanooga, Tenn.....	21,382	34.3	Mar. 11, 1867
Ohio River.....	Pittsburg, Pa.....	19,100	22.9	Mar. 15, 1907
Sacramento.....	Red Bluff, Cal.....	10,400	24.4	Feb., 1909
Potomac.....	Point of Rocks, Md.....	9,654	48.9	June 2, 1889
Potomac.....	Point of Rocks, Md.....	9,654	22.6	Mar., 1902
Allegheny.....	Kittanning, Pa.....	9,010	26.6	Mar. 20, 1905
Savannah.....	Augusta, Ga.....	7,500	40.0	Sept. 11, 1888
Delaware.....	Lambertville, N. J.....	6,855	37.1	Jan. 8, 1841
Salt.....	McDowell, Ariz.....	6,255	26.1	
Monongahela.....	Lock No. 4, Pa.....	5,430	38.1	July 11, 1888
Hudson.....	Mechanicsville, N. Y.....	4,500	26.6	Mar. 28, 1913
Kennebec.....	Waterville, Me.....	4,270	35.3	Dec. 16, 1901
Neosho.....	Iola, Kans.....	3,670	20.3	July 10, 1904
Feather.....	Oroville, Cal.....	3,640	51.3	Mar., 1907
Mohawk.....	Cohoes, N. Y.....	3,472	28.5	Mar. 27, 1913
Chattahoochee.....	West Point, Ga.....	3,300	26.8	Dec. 30, 1901
Shenandoah.....	Millville, W. Va.....	2,995	46.6	Oct., 1896
Catawba.....	Rock Hill, S. C.....	2,987	50.5	May 23, 1901
Hudson.....	Glens Falls, N. Y.....	2,760	25.3	Mar. 28, 1913
New River.....	Radford, Va.....	2,725	63.3	May, 1901
Savannah.....	Near Calhoun Falls, S. C.....	2,712	27.7	Feb. 14, 1900
Kennebec.....	Bet. Forks and Waterville	2,700	48.5	Dec. 16, 1901
Chemung.....	Chemung, N. Y.....	2,440	21.5	Mar. 28, 1913
Ocmulgee.....	Macon, Ga.....	2,425	20.9	Mar. 1, 1902
Androscoggin.....	Rumford Falls, Me.....	2,320	23.8	Apr. 22, 1895

TABLE XLIII.—EXTREME FLOOD DISCHARGES—Continued

Stream	Locality	Drainage Area, in Sq. Miles	Maximum Discharge in Cu.ft. per Sec. per Sq. Mile.	Date of Flood
N. Fork Feather.....	Big Bend, Cal.....	1,940	56.3	Mar. 19, 1907
American.....	Fair Oaks, Cal.....	1,910	55.0	Mar., 1907
Kings River.....	Near Sanger, Cal.....	1,740	25.2	Jan., 1901
Kiskiminetas.....	Avonmore, Pa.....	1,720	39.1	Mar., 1908
Allegheny.....	Red House, N. Y.....	1,640	25.0	Mar. 2, 1910
San Joaquin.....	Hamptonville, Cal.....	1,637	36.5	Jan., 1881
S. Fork Shenandoah.....	Near Front Royal, Va.....	1,570	48.9	Mar., 1902
Chattahoochee.....	Oakdale, Ga.....	1,560	31.2	Dec. 30, 1901
Catawba.....	Catawba, N. C.....	1,535	61.8	May 23, 1901
Tuolumne.....	Lagrange, Cal.....	1,500	35.0	Jan., 1911
Cheat.....	Morgantown, W. Va.....	1,380	30.3	Jan., 1911
Chagres.....	Gatun, Panama.....	1,320	93.9	Dec. 28, 1909
Yuba.....	Near Smartsville, Cal.....	1,220	90.9	Jan., 1909
Merced.....	Near Merced Falls, Cal.....	1,090	34.1	Jan., 1911
Scioto.....	Columbus, Ohio.....	1,047	80.8	Mar. 25, 1913
Flint.....	Near Woodbury, Ga.....	988	30.6	Feb. 28, 1902
Stanislaus.....	Knight's Ferry, Cal.....	935	61.1	Mar., 1907
Clarion.....	Clarion, Pa.....	910	43.2	Mar., 1905
Schoharie Creek.....	Fort Hunter, N. Y.....	909	44.5	Mar. 27, 1913
Schoharie Creek.....	Fort Hunter, N. Y.....	900	55.1	Mar. 2, 1901
Youghiogheny.....	Below Confluence, Pa.....	875	52.6	Aug. 21, 1888
Passaic.....	Dundee, N. J.....	823	38.1	Oct. 10, 1903
Raritan.....	Bound Brook, N. J.....	806	64.5	Sept. 24, 1882
Putah Creek.....	Winters, Cal.....	805	37.2	Mar., 1907
Hudson.....	North Creek, N. Y.....	804	35.0	Mar. 28, 1913
Chagres.....	Bohio, Panama.....	779	115.5	Dec. 27, 1909
Broad.....	Near Carlton, Ga.....	762	38.2	Feb. 28, 1902
Little Tennessee.....	Judson, N. C.....	675	85.3	Dec., 1901
Monocacy.....	Near Frederick, Md.....	660	31.0	Mar., 1902
McCloud.....	Near Gregory, Cal.....	608	68.2	Mar., 1904
Hoosic.....	Johnsonville, N. Y.....	605	38.0	Mar. 28, 1913
Stony Creek.....	Near Fruto, Cal.....	601	48.7	Feb., 1909
Tugaloo.....	Near Madison, S. C.....	593	36.8	July 1, 1905
Santa Catarina.....	Monterey, Mex.....	544	590.0	Aug. 27, 1909
Coosawattee.....	Carters, Ga.....	531	31.9	May 21, 1901
Cosumnes.....	Michigan Bar, Cal.....	524	42.7	Jan., 1911
Clemtangy.....	Columbus, Ohio.....	514	70.0	Mar. 25, 1913
Deerfield.....	Shelburne Falls, Mass.....	501	42.5	Apr. 15, 1909
San Luis Rey.....	San Luis Rey, Cal.....	500	200.0	1916
Ausable River.....	Ausable Forks, N. Y.....	487	45.2	Mar. 27, 1913
Cattaraugus Creek.....	Versailles, N. Y.....	467	53.5	Mar. 25, 1913
Casselman.....	Confluence, Pa.....	448	44.0	Mar., 1907
Youghiogheny.....	Confluence, Pa.....	435	52.0	Mar., 1907
Chagres River.....	Alhajuela, Panama.....	427	398.1	Dec. 26, 1909
Rio Mora.....	Weber, N. Mex.....	422	65.7	Sept. 29, 1904
Hiwassee.....	Murphy, N. C.....	410	54.5	Mar. 19, 1899
Tygart River.....	Belington, W. Va.....	403	40.8	July, 1907

TABLE XLIII.—EXTREME FLOOD DISCHARGES—Continued

Stream	Locality	Drainage Area, in Sq. Miles	Maximum Discharge in Cu.ft. per Sec. per Sq. Mile	Date of Flood
Pocolet.....	Spartanburg, S. C.....	400	88.9	June 6, 1903
Calaveras.....	Jenny Lind, Cal.....	395	176.2	Jan., 1911
Middle Oconee.....	Near Athens, Ga.....	395	49.5	Feb. 28, 1902
Black Lick.....	Black Lick, Pa.....	386	50.8	Mar., 1905
Pompton.....	Two Bridges, N. Y.....	380	61.6	Oct. 10, 1903
Rondout Creek.....	Rosendale, N. Y.....	380	51.3	Apr. 26, 1910
Esopus Creek.....	Mt. Marion, N. Y.....	378	65.3	Apr. 26, 1910
W. Canada Creek.....	Trenton Falls, N. Y.....	376	96.5	Dec. 15, 1901
W. Canada Creek.....	Trenton Falls, N. Y.....	376	69.1	Mar. 28, 1913
W. Canada Creek.....	Hinckley, N. Y.....	372	104.5	Apr. 21, 1869
Piscataquis.....	Foxcroft, Me.....	286	77.6	Sept. 29, 1909
Bear River.....	Van Trent, Cal.....	263	98.1	Mar., 1907
East Canada Creek.....	Dolgeville, N. Y.....	256	54.3	Mar. 27, 1913
Esopus Creek.....	Olivebridge, N. Y.....	239	64.4	Apr. 26, 1910
Toccoa.....	Near Blue Ridge, Ga.....	231	53.0	Aug. 23, 1901
San Gabriel.....	Near Azusa, Cal.....	229	117.0	Feb., 1914
San Gabriel.....	Near Azusa, Cal.....	222	215.0	1884
Arroyo Seco.....	Near Soledad, Cal.....	215	140.0	Nov. 21, 1900
Catskill Creek.....	S. Cairo, N. Y.....	210	100.0	Spring, 1901
Fishkill Creek.....	Glenham, N. Y.....	198	69.2	Mar. 1, 1902
Sweetwater River.....	California.....	186	96.0	1915
E. Branch Fish Creek.....	Taberg, N. Y.....	169	65.0	Mar. 27, 1913
Ramapo River.....	Pompton, N. J.....	160	65.8	Sept. 22, 1882
Rio Mora.....	Below Mora, N. Mex.....	159	139.7	Sept. 29, 1904
Turtle Creek.....	East Pittsburg, Pa.....	146	64.2	Mar., 1904
Devil's Creek.....	Near Viele, Ia.....	143	1300.0	June 10, 1905
Santa Ysabel Creek.....	Near Escondido, Cal.....	128	50.7	Jan., 1909
E. Branch Fish Creek.....	Point Rock, N. Y.....	104	80.5	Fall, 1897
Little Stony Creek.....	Near Lodoga, Cal.....	102	69.2	Feb., 1909
Wanaque River.....	Pompton, N. J.....	101	83.6	Oct. 10, 1910
Putah Creek.....	Guenoc, Cal.....	91	198.9	Mar., 1904
Cedar River.....	Near Seattle, Wash.....	79	120.0	Nov., 1911
Loramie Reservoir Outlet.....	Ohio.....	72	97.2	Mar. 25, 1913
Pequannock River.....	Macopin, N. J.....	62	90.8	Oct. 10, 1903
N. Fork Cottonwood Creek.....	Ono, Cal.....	52	77.7	Feb., 1909
Six Mile Creek.....	Ithaca, N. Y.....	46	185.0	June 21, 1905
Elkhorn Creek.....	Keystone, W. Va.....	44	1303.0	June 22, 1901
Basic Creek.....	Freehold, N. Y.....	41	81.0	Spring, 1901
Whippany River.....	Whippany, N. J.....	38	84.0	Feb. 6, 1896
Arroyo Seco.....	Devil's Gate, Cal.....	30.5	352.0	Feb., 1914
Bear Grass Creek.....	Louisville, Ky.....	27.5	100.0	Feb. 22, 1908
Pequannock River.....	Near Bridgeport, Conn.....	25.0	157.0	July 29, 1905
Pinal Creek.....	Globe, Ariz.....	25.0	560.0	Aug. 17, 1904
Cane Creek.....	Bakersville, N. C.....	22.0	1341.0	May 20, 1901
Willow Creek.....	Near Heppner, Ore.....	20.0	1800.0	June 14, 1903
Yuba River.....	Bowman Dam.....	19.0	368	
Mill Creek.....	Erie, Pa.....	12.9	850.0	Aug. 3, 1915

TABLE XLIII.—EXTREME FLOOD DISCHARGES—Continued

Stream	Locality	Drainage Area, in Sq. Miles	Maximum Discharge in Cu.ft. per Sec. per Sq. Mile	Date of Flood
Goodyear Creek.....	Goodyear, Pa.	12.2	96.0	Jan. 30, 1911
Mill Brook.....	Sherburne, N. Y.....	9.4	241.0	Sept. 4, 1905
Sunland Wash.....	Near Pasadena, Cal.....	6.5	712.0	Feb., 1914
Estanzuela.....	Near Monterey, Mex.....	3.5	825.0	Aug. 28, 1909
Starch Factory Creek.....	New Hartford, N. Y.....	3.4	151.0	July 11, 1905
Rio Grande.....	Near Culebra, Panama.....	2.3	161.0	May 25, 1911
Cherryvale Creek.....	Cherryvale, Kans.....	2.0	930.0	
Budlong Creek.....	Utica, N. Y.....	1.1	120.0	Mar. 25, 1904
Beacon Brook.....	Fishkill, N. Y.....	0.2	3200.0	July 14, 1897
II. EUROPEAN STREAMS:				
Durance River.....	Bonpas, France.....	5714	37.0	Nov. 11, 1886
Allier River.....	At junction with Loire, France	5548	30.0	1856
Durance.....	Mirabeau, France.....	4533	52.0	Nov. 11, 1886
Allier.....	Nevers, France.....	4500	37.0	
Vistula.....	Gracow, Galicia.....	3180	34.0	1813
Rhine.....	At Lake Constance, Switz.	2555	48.0	
Oder.....	Sagan, Silesia, Germany.....	1638	43.0	July 31, 1897
San River.....	Galicia, Austria.....	1420	64.0	1897
Eder River.....	At junction with Fulda, Germany	1298	35.0	Jan., 1841
Verdun River.....	At junction with Durance, France	932	63.0	Nov. 1, 1843
Glatzer Neisse.....	Silesia, Germany.....	906	47.0	
Ardèche.....	At junction with Rhone, France	831	382.0	1827
Werre.....	At mouth, Germany.....	575	48.0	Feb., 1799
"	"	"	32.0	Nov., 1890
Eder.....	Hemfurt, Germany.....	552	58.0	
Buech.....	At junction with Durance, France	552	84.0	Nov. 1, 1843
Bober.....	Near Mauer, Silesia.....	467	91.0	July, 1897
Hotzenplotz.....	At junction with Oder, Germany	300	77.0	July 21, 1903
Ubaya.....	At junction with Durance, France	361	127.0	Nov. 1, 1843
Coulon.....	"	352	100.0	"
Bleone.....	"	351	116.0	"
Moselle.....	Epinal, France.....	313	90.0	
Asee River.....	At junction with Durance, France	285	111.0	Nov. 1, 1843
Wupper.....	At mouth, Westphalia, Germany	240	90.0	
Ardèche.....	Vans, France.....	215	525.6	1890
Bober River.....	Rohrlach, Germany.....	204.6	160.1	July 30, 1897
Queis River.....	Lauban, Germany.....	187.4	161.2	July 30, 1897

TABLE XLIII.—EXTREME FLOOD DISCHARGES—*Continued*

Stream	Locality	Drainage Area, in Sq. Miles	Maximum Discharge in Cu.ft. per Sec. per Sq. Mile	Date of Flood
Ardèche.....	Aubenas, France.....	178.0	694.41	1890
Queis River.....	Marklissa, Germany.....	118.0	262.7	Aug. 3, 1888
"	"	118.0	233.3	July 30, 1897
Queis River.....	Greiffenberg, Germany.....	78.0	172.0	July 30, 1897
Bargalino Creek.....	Genoa, Italy.....	35.6	485.0	Oct., 1892
"	"	35.6	421.0	July 18, 1908
Eyaoh River.....	Balingen, Wurtemberg.....	34.75	356.0	June 5, 1895
Urnasch.....	St. Gallen, Switzerland.....	30.0	153.0	
Goldbach.....	At Arnoldsdorf, Germany.....	19.7	268.8	July 21, 1903
Queis River.....	Near Head, Germany.....	12.34	358.0	July 31, 1897
Little Aupa.....	Near Head, Germany.....	11.9	385.63	
Furens River.....	St. Eitenne, France.....	9.65	478.0	1849
Bargalino Creek.....	Above Genoa, Italy.....	8.8	732.0	Oct., 1892
Eyaoh River.....	Margarethausen, Wurtemberg	7.34	788.8	June 5, 1895
Dabrowka Creek.....	Near Sambor, Austria.....	5.02	253.2	
III. INDIAN STREAMS				
Irawaddy.....	India.....	149,800	12.7	
Khishna.....	India.....	345	342.6	
Tansa.....	India.....	52	667.0	

Professor Kuichling has proposed a formula for maximum discharge which he calls especially applicable to the South Atlantic States:

$$Q = \frac{41.6(620 + M)}{24 + M}$$

Fanning gives the following:

$$Q = 200(M)^{\frac{2}{3}}$$

in which Q = Maximum Discharge;

M = Drainage area in square kilometers.

Neither of these formula makes allowance for differences in rainfall, grade or steepness of country, character of soil or

topography, all of which, especially the first, have great influence on the volume of maximum discharge.

Colonel Ryves has derived the following formula from experience in India:

$$D = C\sqrt[3]{M^2}$$

in which M is area in square miles, D is the flood discharge, and C is a coefficient varying with the rainfall and slope of the country. For regions where maximum rainfalls are from 4 to 5 inches in twenty-four hours, the values of C in the above formula have been found to be in flat country C equals 400 to 500; in hilly country C equals 500 to 650.

A formula is here proposed as follows:

$$Q = RC(M)^{\frac{1}{2}}$$

in which R equals the maximum rainfall in inches in twenty-four hours;

C varies from 100 for undulating areas, to 200 for mountainous areas; and

M equals area in square miles.

None of these formulæ can be expected to give approximate results, on account of the many complications involved, and the uncertainty of all the data except the area of drainage basin. The shape of the basin, the character of the soil and vegetation and many minor factors which affect the result, are impossible to allow for with any approach to accuracy.

Cost and Dimensions of Some Great Storage Reservoirs.—In Table XLIV are given the capacities, material, dimensions, purpose and cost per acre-foot of some of the great storage reservoirs built by the U. S. Government for irrigation.

TABLE XLIV.—RESERVOIRS BUILT BY U. S. RECLAMATION SERVICE

Name and Locality	Area, Acres	Capacity, Acre-feet	Annual Draft	Cost	Year Built
Roosevelt, Ariz.....	16,832	1,365,000	450,000	\$3,883,000	1911
East Park, Cal.....	1,850	51,000	30,000	287,000	1910
Deerflat, Ida.....	9,835	177,660	177,660	1,048,000	1912
Jackson Lake, Ida.....	25,530	789,000	700,000	1,253,000	1915
Minidoka, Ida.....	11,350	150,000	53,500	690,000	1906
Arrowrock, Ida.....	2,860	250,000	200,000	4,772,000	1915
Pathfinder, Wyo.....	22,700	1,070,000	500,000	1,827,000	1909
Minatare, Neb.....	2,240	67,025	67,025	564,000	1914
Lahontan, Nev.....	12,000	290,000	290,000	1,580,000	1915
MacMillan, N. Mex.*.....	7,860	70,000	40,000	143,000	1892
Avalon, N. Mex.....	970	6,200	1912
Elephant Butte, N. M.....	40,080	2,368,000	720,000	4,866,000	1916
Cold Springs, Ore.....	1,500	50,000	40,000	446,000	1908
Clear Lake, Ore.—Cal.....	25,000	462,000	10,000	138,000	1910
Belle Fourche, S. D.....	8,010	203,000	203,000	1,237,000	1911
Strawberry, Utah.....	8,370	100,000	100,000	612,000	1913
Bumping Lake, Wash.....	1,350	34,000	34,000	555,000	1910
Lake Kachess, Wash.....	4,800	210,000	180,000	840,000	1912
Lake Keechelus, Wash.....	2,550	152,000	152,000	1,397,000	1917
Shoshone, Wyo.....	6,600	70,000	470,000	1,350,000	1910

* Built by Pecos Irrigation Co.

TABLE XLV.—EARTH DAMS AND ROCKFILL DAMS

Name and Locality	Purpose	BUILT		Crest L'gth	Maxi. High	Volume, Cu. Yd.	Cost
		By	Year				
Arrowhead, Cal.	Power	Private	850	222
Calaveras, Cal.	Domestic	Private	1,300	240	3,085,000
Horseshoe Bend, Can.	Irrig.	Private	7,000	45	1,000,000
Las Vegas, N. M.	Irrig.	Public	1,400	75	450,000
Sugar Loaf, Col.	Indus.	Private	5,000	40	90,200	127,655
San Pablo, Cal.	Domestic	Private	1,300	165	1,500,000
Talla, Scotland.	Domestic	Public	1,050	80	500,000
Dixville, N. H.	Power	Private	1908	500	76	83,500
Laramie River, Wyo.	Irrig.	Private	1901	8,000	34	344,000
Ashti, India.	Irrig.	12,709	58
Balmorhea, Tex.	Irrig.	Private	3,900	47
Cuyamaca, Cal.	Irrig.	Private	1894	635	41½	54,400
McAlester, Okla.	Domestic	Public	480	54	84,000	44,965
Kinder River, Eng.	Domestic	Public	1200	116	732,000
Necaxa, Mexico.	Power	Private	975	190	2,130,000
Gatun, Panama.	R. cont'l	Public	21,000,000
Eacondido, Cal.	Irrig.	Private	1911	380	76	37,159	86,946
Lower Otay, Cal.	Domestic	Private	1897	565	161	180,000
McMillan, N. M.	Irrig.	Private	1893	1,686	52	102,400	200,000
E. Canyon Creek, Utah.	Irrig.	Private	1899	100	83	40,000
Merced, Cal.	Irrig.	Private	1884	2,200	50
San Andres, Cal.	Domestic	Public	1875	850	93
Pilarcitos, Cal.	Domestic	Public	640	95
Pecos Valley, No. 1, N. M.	1890	1,380	48
Pecos Valley, No. 2, N. M.	1893	1,686	52	170,000
La Mesa, Cal.	1895	470	55	38,000	17,000
Lagastrello, Italy.	Irrig.	Public	550	69	124,000
Domodossola, Italy.	Irrig.	Public	365	101	143,000
Sevier R., Utah.	1,300	680,000
Morris, Conn.	Domestic	Public	1914	1,100	100	651,000
Throttle, N. M.	Flood	Private	1,060	77	200,000 ¹
Somerset.	Power	Private	1913	2,080	106
Morena, Cal.	Domestic	Private	505	265	306,000	1,100,000 ¹
Bowman, Cal.	Private	1872	425	100	55,000	151,521
Seros Project Dams:							
No. 1.	Power	Private	57	1,273	270,400
No. 2.	Power	Private	41	886	58,890
No. 3.	Power	Private	75	1312	497,250
No. 4.	Power	Private	33	510	41,808
No. 5.	Power	Private	40	682	76,634
No. 6.	Power	Private	30	351	42,510
No. 7.	Power	Private	47	781	59,800

¹ With accessories.

TABLE XLVI.—MASONRY DAMS

Name and Locality	Purpose	BUILT		Crest L'gth	Max. Height	Volume, Cu. Yd.	Cost
		By	Year				
Arrowrock, Ida.	Irrig.	Public	1915	1100	349	585,130	4,404,000
Ash Fork, Ariz.	Railroad	Private	1808	300	46	1,500	45,776
Assiout, Egypt.	Irrig.	Public	1902	2769	48	221,694	2,450,000 ¹
Assuan, Egypt.	Irrig.	Public	1912	6400	131	1,179,000	18,660,000
Auckland, N. Zealand.	Domestic	Public	533	71
Azischos, Maine.	Power	Private	881	78
Ban, France.	Domestic	Public	1870	157	190,000
Badana, Italy.	Irrig.	Public	715	188	132,000	465,000
Barker, Colo.	Power	Private	1909	625	185	140,000
Barossa, N. S. W.	1903	472	95
Barren Jack, Australia.	Irrig.	Public	1911	784	240	320,000	3,680,000 ²
Big Bear Valley, Cal.	Irrig.	Private	1912	363	92	4,684	133,528
Beetaloo, Australia.	Domestic	Public	1890	580	110	60,000	570,000
Betwa, India.	Irrig.	Public	1897	3296	64	170,000
Bhatgur, India.	Irrig.	Public	1891	4067	130	404,800
Bober, Germany.	Power	Public	1912	918	203	332,000	1,416,000 ³
Boonton, N. J.	Domestic	Public	1906	2150	114	255,327	1,500,000 ³
Boyd's Corner, N. Y.	Domestic	Public	1870	670	78	27,000	370,000
Brasimone, Italy.	Domestic	Public	530	115	50,000	130,000 ⁴
Bridgeport, Conn.	Domestic	Public	1886	640	42½
Cabbage Tree, Australia.	Domestic	Private	580	125	58,400
Cataract, Australia.	Domestic	Public	1908	811	102	146,242	1,602,000
Chartrain, France.	Domestic	Public	1892	180	420,000
Chautiere, Canada.	R. cont'l	Private	1300
Chuviacar, Mexico.	Domestic	Public	787	174
Coolgardie, Australia.	Domestic	Public	1902	755	197
Cross River, N. Y.	Domestic	Public	1909	986	170	156,467	1,389,120
Croton Falls, N. Y.	Domestic	Public	1911	1100	173	290,540
Crowley Creek, Ore.	Irrig.	Private	1914	170	60	800	12,500
Derwent, England.	Domestic	Private	1110	114
East Park, Cal.	Irrig.	Public	1910	250	139	12,200	155,727
Einsiedel, Germany.	Domestic	Public	1894	590	93	31,600	312,500
Elephant Butte, N. M.	Irrig.	Public	1916	1674	318	605,200	4,913,000
Folsom, Cal.	Power	Public	1891	476	98	48,590
Furens, France.	Pld. prot.	Public	1866	330	170	52,300	318,000
Gem Lake, Cal.	Power	Private	700	112	8,500
Gillepe, Belgium.	Domestic	Public	1875	771	154	325,000	874,000
Gorzente, Italy.	Domestic	Public	1882	492	121
Goodwin, Cal.	Irrig.	Private	1913	233	70
Granite Springs, Wyo.	1904	410	96	14,422	109,194
Habra, Algiers.	Irrig.	Public	1873	755	197
Hale's Bar, Tenn.	Power	Private	1913	1200	76
Hatfield, Wis.	Power	Private	400	50	24,000
Hemlock, Conn.	Domestic	Public	1300	96
Henne, Germany.	Domestic	Public	1904	1210	124	140,000
Hindia Barrage, Mesopot.	Irrig.	Public	1913	834	25
Howden, England.	Domestic	Private	1080	117
Huacal, Mexico.	Indus.	Private	1912	140	100	4,988	114,290
Hume-Bennett.	Private	677	61	2,207	46,000
Indian River, N. Y.	Power	Private	1890	207	47
Kensico, N. Y.	Domestic	Public	1915	1850	310	913,050
Keokuk, Ia.	Power	Private.	1913	4278	37

¹ Contract price.² Estimated.³ Approximate⁴ With accessories.

TABLE XLVI.—MASONRY DAMS—Continued

Name and Locality	Purpose	BUILT		Crest L'gth	Max. Hight	Volume, Cu. Yd.	Cost
		By	Year				
La Boquilla, Mexico.....	Irrig.	840	261	390,000	
La Grange, Cal.....	Irrig.	Private	1894	320	129	39,500	550,000
La Jalpa, Mexico.....	1902	1800	87	92,000	500,000
Lake Cheesman, Cal.....	Domestic	1904	710	227	103,000
Lake Fife, India.....	Irrig.	Public	5136	98	360,000	630,000
La Prele, Wyo.....	Irrig.	Private	1909	360	135	32,500	300,000 ¹
Lauchensee, Germany.....	1895	840	98	37,400	243,750
Lister, Germany.....	Domestic	Public	1913	140,000
Little Bear Valley, Cal.....	Irrig.	Private	880	200
Marklissa, Germany.....	Flood	Private	1905	427	148	83,700	595,000
Mauer, Germany.....	Public	1912	918	203	332,000	1,416,000
Medina, Tex.....	Irrig....	Private	1913	1580	180	205,000
Mercedes, Mexico.....	Irrig.	Private	1905	535	133	28,000	200,000
Moehne, Germany.....	Domestic	Public	2100	131	353,000	5,000,000 ⁴
Mountain Dell, Utah.....	Domestic	Public	1917	100	8,300	90,000
New Croton, N. Y.....	Domestic	Public	1906	1200	238	855,000	6,886,872
New Dam, Mexico.....	Irrig.	Public	1800	85	92,000	540,000
New Hauser, Mo.....	Power	Private	1911	490	132	85,000
Oder, Germany.....	Flood	Public	1905	750	88	36,200	204,000
Olive Bridge, N. Y.....	Domestic	Public	1000 4650	251	488,200	853,200 ¹
Pas Du Riot, France.....	Domestic	Public	1878	113	256,000
Pathfinder, Nebr.....	Irrig.	Public	1909	432	173	60,210
Periar, India.....	Irrig.	Public	1897	1231	218	185,000
Remscheid, Germany.....	Domestic	Public	1892	82	22,886	91,154
Roosevelt, Ariz.....	Irrig.	Public	1911	1125	280	342,325	3,893,000
Rio Das Lages, Brazil.....	Power	Private	1907	135	63,000
Salmon River, Idaho.....	Irrig.	Private	1914	480	225
San Jose, Mexico.....	Private	592	151	400,000
San Mateo, Cal.....	Domestic	Private	1889	580	146	139,000
Seligman, Ariz.....	Private	1898	643	68	28,511	150,000
Shoshone, Wyo.....	Irrig.	Public	1910	200	328	78,576	1,356,000
Sodom, N. Y.....	Domestic	Public	1893	500	98	35,887	366,499
Scovell Creek, Australia.....	1916	155	50
Spiers Falls, N. Y.....	Power	Private	1905	552	150	180,000
Swanzy, Wales.....	Domestic	Public	1250	144
Sweetwater, Cal.....	Irrig.	Private	1888	380	98	20,507	234,074
Tansa, India.....	Domestic	Public	1891	8800	118	408,520	988,000
Ternay, France.....	Domestic	Public	124	204,372
Titicus, N. Y.....	Domestic	Public	1895	534	109	149,000	933,065 ¹
Triunfo Creek, Cal.....	1913	148	50
Urft, Germany.....	Private	1904	741	190
Vy-nwy, Wales.....	Domestic	Public	1889	1350	136	260,000	2,957,000
Villar, Spain.....	Domestic	Public	1878	547	170	390,000
Waldeck, Germany.....	Domestic	Private	900	160	1,880,950 ²
Wauchussets, Mass.....	Domestic	Public	1906	1476	228	274,439	2,378,206
Wigwam, Conn.....	Domestic	Public	1902	600	75	14,887	150,000
Williams, Ariz.....	Storage	Private	1894	385	46	5,226	52,833
Wofelsgrund, Germany.....	Flood	Public	1907	367	95	26,200	102,000
Yadkin Narrows, N. C.....	Power	Private	1400	217	525,000
Zola, Spain.....	Domestic	Public	1843	205	123

¹ Contract price.

² Estimated.

³ Approximate.

⁴ With accessories.

VELOCITY TABLES

Tables XLVII to LIII give the values of the mean velocity of water in open channels computed from Kutter's formula:

$$v = \left\{ \frac{\frac{1.811}{n} + 41.6 + \frac{0.00281}{s}}{1 + \left[41.6 + \frac{0.00281}{s} \right] \frac{n}{\sqrt{r}}} \right\} \sqrt{rs}$$

The values of n , the coefficient of roughness, to be used in finding v , depend on the roughness of the materials forming the bed and banks of the channel, irregularities and imperfections in the bed or banks, curves, eddies, aquatic plants, and other conditions that tend to produce a retardation of flow. Experimental data on the subject are limited and the commonly accepted values of n for specific conditions must be considered as mere approximations. These approximate values, based on a consideration of the data available, are as follows:

$n=0.010$ for clean, straight channels of planed lumber carefully laid; neat cement plaster; glazed, coated and enameled surfaces in perfect order.

$n=0.012$ for clean, straight and regular channels of planed boards not in perfect order due to inferior workmanship or age; unplanned boards carefully laid; metal flumes of the smooth interior type and gentle curvature in alinement; concrete linings having steel troweled surfaces of 1:1 mortar, sand and cement plaster; clean brickwork.

$n=0.014$ for clean, regular channels of concrete having wooden troweled or formed surfaces of good construction, the alinement consisting of tangents connected by gentle curves; unplanned boards not in perfect order due to inferior workmanship or age.

$n=0.015$ for construction as in the preceding case but with sharp curvature or with deposits of silt on the bottom of channel; straight and regular channels of ordinary brickwork; smooth stonework; foul and slightly tuberculated iron.

$n=0.020$ for channels of fine gravel; rough rubble; or tuberculated iron; or for canals in earth, in good condition, lined with well-packed gravel, partly covered with sediment, and free from vegetation.

$n=0.025$ for canals in earth in good condition, or composed of loose gravel without vegetation.

$n=0.025$ for canals and rivers of tolerably uniform cross-section, slope and direction in average condition.

$n=0.030$ for canals and rivers in rather poor condition, having bed partially covered with debris, or having comparatively smooth sides and bed but a channel partially obstructed with grass, weeds or aquatic plants.

$n=0.035$ for canals and rivers in bad order and regimen, having the channel strewn with stones and detritus or about one-third full of vegetation.

Canals in earth with their channels half full of vegetation may have $n=0.040$, and when two-thirds full of vegetation may have $n=0.050$. In exceptional cases the value of n may reach 0.060.

As an indication of the extent to which the value of n affects the velocity of the discharge of channels, let us take an example in which $n=0.0225$. A bed width of 10 feet, depth of 2 feet, and side slopes of 1 to 1, with a grade of 8 feet per mile, gives a velocity of 3.32 feet per second and a discharge of 79.07 second-feet. For the same channel with a value of $n=0.035$ the velocity is 2.05 feet per second and the discharge 49.2 second-feet; thus showing that with the better channel the discharge is 60 per cent greater than with the inferior channel.

NOTE.—To find velocities for slopes other than those given in this table, multiply the tabular velocity found in the column of " $F=52.80$ " by ten times the square root of the slope. The velocity thus obtained is accurate for slopes greater than 6 feet per mile, and approximate for all slopes greater than 4 feet per mile.

TABLE XLVII.—VELOCITY OF WATER IN FEET PER SECOND, BASED ON KUTTER'S FORMULA, COEFFICIENT OF ROUGHNESS, $n = .010$

Area ft. per cent.	$R = .264$ $S = .00005$	$R = .528$ $S = .00010$	$R = .792$ $S = .00015$	$R = 1.056$ $S = .00020$	$R = 1.320$ $S = .00025$	$R = 1.584$ $S = .00030$	$R = 2.112$ $S = .00040$	$R = 2.640$ $S = .00050$	$R = 3.168$ $S = .00060$	$R = 3.696$ $S = .00070$	$R = 4.224$ $S = .00080$	$R = 4.752$ $S = .00090$	$R = 5.280$ $S = .00100$	$R = 7.02$ $S = .00150$	$R = 10.56$ $S = .00220$	$R = 15.84$ $S = .00330$	$R = 21.12$ $S = .00440$	$R = 26.40$ $S = .00550$	$R = 31.68$ $S = .00660$	$R = 42.24$ $S = .00880$	$R = 52.80$ $S = .01100$
0.2	.38	.44	.56	.67	.76	.84	.99	1.11	1.22	1.33	1.42	1.52	1.60	1.97	2.29	2.81	3.25	3.64	3.98	4.60	5.1
0.4	.40	.46	.60	.71	.79	.87	1.04	1.17	1.28	1.39	1.48	1.58	1.66	2.07	2.42	2.98	3.43	3.82	4.16	4.78	5.28
0.6	.41	.48	.64	.75	.83	.91	1.09	1.23	1.34	1.45	1.54	1.64	1.72	2.16	2.54	3.14	3.59	3.98	4.32	4.94	5.44
0.8	.42	.50	.68	.79	.87	.95	1.14	1.28	1.39	1.50	1.59	1.69	1.77	2.23	2.63	3.26	3.71	4.10	4.44	5.06	5.56
1.0	.43	.52	.71	.82	.90	.98	1.18	1.32	1.43	1.54	1.63	1.73	1.81	2.29	2.70	3.35	3.80	4.19	4.53	5.15	5.65
1.2	.44	.54	.74	.85	.93	1.01	1.21	1.35	1.46	1.57	1.66	1.76	1.84	2.33	2.75	3.41	3.86	4.25	4.59	5.21	5.71
1.4	.45	.56	.76	.87	.95	1.03	1.23	1.37	1.48	1.59	1.68	1.78	1.86	2.36	2.78	3.44	3.89	4.28	4.62	5.24	5.74
1.6	.46	.58	.78	.89	.97	1.05	1.25	1.39	1.50	1.61	1.70	1.80	1.88	2.38	2.80	3.46	3.91	4.30	4.64	5.26	5.76
1.8	.47	.59	.80	.91	.99	1.07	1.27	1.41	1.52	1.63	1.72	1.82	1.90	2.40	2.82	3.48	3.93	4.32	4.66	5.28	5.78
2.0	.48	.60	.82	.93	1.01	1.09	1.29	1.43	1.54	1.65	1.74	1.84	1.92	2.42	2.84	3.50	3.95	4.34	4.68	5.30	5.80
2.2	.49	.61	.83	.94	1.02	1.10	1.30	1.44	1.55	1.66	1.75	1.85	1.93	2.44	2.86	3.52	3.97	4.36	4.70	5.32	5.82
2.4	.50	.62	.84	.95	1.03	1.11	1.31	1.45	1.56	1.67	1.76	1.86	1.94	2.46	2.88	3.54	3.99	4.38	4.72	5.34	5.84
2.6	.51	.63	.85	.96	1.04	1.12	1.32	1.46	1.57	1.68	1.77	1.87	1.95	2.48	2.90	3.56	4.01	4.40	4.74	5.36	5.86
2.8	.52	.64	.86	.97	1.05	1.13	1.33	1.47	1.58	1.69	1.78	1.88	1.96	2.50	2.92	3.58	4.03	4.42	4.76	5.38	5.88
3.0	.53	.65	.87	.98	1.06	1.14	1.34	1.48	1.59	1.70	1.79	1.89	1.97	2.52	2.94	3.60	4.05	4.44	4.78	5.40	5.90
3.2	.54	.66	.88	.99	1.07	1.15	1.35	1.49	1.60	1.71	1.80	1.90	1.98	2.54	2.96	3.62	4.07	4.46	4.80	5.42	5.92
3.4	.55	.67	.89	1.00	1.08	1.16	1.36	1.50	1.61	1.72	1.81	1.91	1.99	2.56	2.98	3.64	4.09	4.48	4.82	5.44	5.94
3.6	.56	.68	.90	1.01	1.09	1.17	1.37	1.51	1.62	1.73	1.82	1.92	2.00	2.58	3.00	3.66	4.11	4.50	4.84	5.46	5.96
3.8	.57	.69	.91	1.02	1.10	1.18	1.38	1.52	1.63	1.74	1.83	1.93	2.01	2.60	3.02	3.68	4.13	4.52	4.86	5.48	5.98
4.0	.58	.70	.92	1.03	1.11	1.19	1.39	1.53	1.64	1.75	1.84	1.94	2.02	2.62	3.04	3.70	4.15	4.54	4.88	5.50	6.00
4.2	.59	.71	.93	1.04	1.12	1.20	1.40	1.54	1.65	1.76	1.85	1.95	2.03	2.64	3.06	3.72	4.17	4.56	4.90	5.52	6.02
4.4	.60	.72	.94	1.05	1.13	1.21	1.41	1.55	1.66	1.77	1.86	1.96	2.04	2.66	3.08	3.74	4.19	4.58	4.92	5.54	6.04
4.6	.61	.73	.95	1.06	1.14	1.22	1.42	1.56	1.67	1.78	1.87	1.97	2.05	2.68	3.10	3.76	4.21	4.60	4.94	5.56	6.06
4.8	.62	.74	.96	1.07	1.15	1.23	1.43	1.57	1.68	1.79	1.88	1.98	2.06	2.70	3.12	3.78	4.23	4.62	4.96	5.58	6.08
5.0	.63	.75	.97	1.08	1.16	1.24	1.44	1.58	1.69	1.80	1.89	1.99	2.07	2.72	3.14	3.80	4.25	4.64	4.98	5.60	6.10
5.2	.64	.76	.98	1.09	1.17	1.25	1.45	1.59	1.70	1.81	1.90	2.00	2.08	2.74	3.16	3.82	4.27	4.66	5.00	5.62	6.12
5.4	.65	.77	.99	1.10	1.18	1.26	1.46	1.60	1.71	1.82	1.91	2.01	2.09	2.76	3.18	3.84	4.29	4.68	5.02	5.64	6.14
5.6	.66	.78	1.00	1.11	1.19	1.27	1.47	1.61	1.72	1.83	1.92	2.02	2.10	2.78	3.20	3.86	4.31	4.70	5.04	5.66	6.16
5.8	.67	.79	1.01	1.12	1.20	1.28	1.48	1.62	1.73	1.84	1.93	2.03	2.11	2.80	3.22	3.88	4.33	4.72	5.06	5.68	6.18
6.0	.68	.80	1.02	1.13	1.21	1.29	1.49	1.63	1.74	1.85	1.94	2.04	2.12	2.82	3.24	3.90	4.35	4.74	5.08	5.70	6.20
7.0	.70	.82	1.04	1.15	1.23	1.31	1.51	1.65	1.76	1.87	1.96	2.06	2.14	2.84	3.26	3.92	4.37	4.76	5.10	5.74	6.24

VELOCITY TABLES

TABLE XLVIII. VELOCITY OF WATER IN FEET PER SECOND, COEFFICIENT OF ROUGHNESS, $n = .012$

Area in sq. ft.	Wet per.		Coefficient of Roughness, $n = .012$																						
	$R = .304$	$R = .00005$	$R = 1.584$	$R = 1.330$	$R = 1.00015$	$R = 1.056$	$R = 1.00020$	$R = 1.00035$	$R = 1.00043$	$R = 2.112$	$R = 1.640$	$R = 3.168$	$R = 3.696$	$R = 4.224$	$R = 4.752$	$R = 5.280$	$R = 7.92$	$R = 10.56$	$R = 15.84$	$R = 20.1$	$R = 26.40$	$R = 31.68$	$R = 42.24$	$R = 52.80$	
0.2	.22	.31	.77	.87	.95	1.03	1.12	1.21	1.30	1.41	1.51	1.61	1.71	1.81	1.91	2.01	2.11	2.21	2.31	2.41	2.51	2.61	2.71	2.81	2.91
0.4	.39	.60	1.12	1.37	1.48	1.63	1.76	1.89	2.01	2.12	2.23	2.34	2.45	2.56	2.67	2.78	2.89	3.00	3.11	3.22	3.33	3.44	3.55	3.66	3.77
0.6	.52	.80	1.02	1.37	1.51	1.76	2.01	2.23	2.45	2.67	2.89	3.11	3.33	3.55	3.77	4.00	4.22	4.44	4.66	4.88	5.11	5.33	5.55	5.77	6.00
0.8	.68	1.02	1.28	1.50	1.66	1.86	2.10	2.43	2.73	3.03	3.33	3.63	3.93	4.23	4.53	4.83	5.13	5.43	5.73	6.03	6.33	6.63	6.93	7.23	7.53
1.0	.81	1.20	1.50	1.75	1.97	2.22	2.52	2.83	3.13	3.43	3.73	4.03	4.33	4.63	4.93	5.23	5.53	5.83	6.13	6.43	6.73	7.03	7.33	7.63	7.93
1.2	.93	1.37	1.71	2.00	2.23	2.48	2.85	3.20	3.55	3.90	4.25	4.60	4.95	5.30	5.65	6.00	6.35	6.70	7.05	7.40	7.75	8.10	8.45	8.80	9.15
1.4	1.05	1.53	1.90	2.21	2.48	2.78	3.16	3.55	3.94	4.32	4.71	5.10	5.49	5.88	6.27	6.66	7.05	7.44	7.83	8.22	8.61	9.00	9.39	9.78	10.17
1.6	1.15	1.68	2.08	2.42	2.71	2.98	3.40	3.87	4.25	4.59	4.91	5.21	5.50	5.79	6.08	6.37	6.66	6.95	7.24	7.53	7.82	8.11	8.40	8.69	8.98
1.8	1.26	1.82	2.26	2.62	2.94	3.22	3.73	4.18	4.58	4.96	5.30	5.63	5.93	6.23	6.53	6.83	7.13	7.43	7.73	8.03	8.33	8.63	8.93	9.23	9.53
2.0	1.36	1.96	2.42	2.81	3.15	3.45	4.00	4.47	4.90	5.30	5.67	6.02	6.34	6.64	6.94	7.24	7.54	7.84	8.14	8.44	8.74	9.04	9.34	9.64	9.94
2.2	1.46	2.00	2.58	2.99	3.35	3.67	4.25	4.76	5.21	5.63	6.03	6.39	6.74	7.07	7.37	7.67	7.97	8.27	8.57	8.87	9.17	9.47	9.77	10.07	10.37
2.4	1.55	2.22	2.73	3.16	3.54	3.88	4.47	5.03	5.51	5.95	6.37	6.75	7.12	7.49	7.84	8.14	8.44	8.74	9.04	9.34	9.64	9.94	10.24	10.54	10.84
2.6	1.64	2.34	2.88	3.33	3.73	4.09	4.73	5.29	5.79	6.20	6.69	7.10	7.48	7.84	8.14	8.44	8.74	9.04	9.34	9.64	9.94	10.24	10.54	10.84	11.14
2.8	1.73	2.50	3.02	3.49	3.91	4.29	4.96	5.54	6.07	6.50	7.01	7.44	7.84	8.14	8.44	8.74	9.04	9.34	9.64	9.94	10.24	10.54	10.84	11.14	11.44
3.0	1.82	2.58	3.10	3.65	4.09	4.47	5.17	5.78	6.34	6.84	7.32	7.70	8.08	8.38	8.68	8.98	9.28	9.58	9.88	10.18	10.48	10.78	11.08	11.38	11.68
3.2	1.90	2.60	3.30	3.81	4.26	4.66	5.38	6.02	6.50	7.12	7.63	8.08	8.51	8.84	9.14	9.44	9.74	10.04	10.34	10.64	10.94	11.24	11.54	11.84	12.14
3.4	1.98	2.80	3.43	3.96	4.42	4.84	5.59	6.25	6.85	7.39	7.90	8.38	8.84	9.14	9.44	9.74	10.04	10.34	10.64	10.94	11.24	11.54	11.84	12.14	12.44
3.6	2.06	2.91	3.55	4.10	4.58	5.02	5.79	6.47	7.00	7.66	8.10	8.68	9.15	9.44	9.74	10.04	10.34	10.64	10.94	11.24	11.54	11.84	12.14	12.44	12.74
3.8	2.14	3.01	3.68	4.24	4.74	5.19	5.99	6.69	7.33	7.91	8.46	8.97	9.46	9.74	10.04	10.34	10.64	10.94	11.24	11.54	11.84	12.14	12.44	12.74	13.04
4.0	2.22	3.11	3.80	4.37	4.86	5.35	6.18	6.91	7.57	8.17	8.73	9.26	9.75	10.04	10.34	10.64	10.94	11.24	11.54	11.84	12.14	12.44	12.74	13.04	13.34
4.2	2.29	3.21	3.92	4.52	5.04	5.52	6.37	7.11	7.79	8.41	8.99	9.53	10.1	10.34	10.64	10.94	11.24	11.54	11.84	12.14	12.44	12.74	13.04	13.34	13.64
4.4	2.37	3.31	4.04	4.65	5.19	5.68	6.55	7.32	8.01	8.65	9.25	9.80	10.3	10.64	10.94	11.24	11.54	11.84	12.14	12.44	12.74	13.04	13.34	13.64	13.94
4.6	2.44	3.40	4.15	4.78	5.33	5.84	6.73	7.52	8.23	8.89	9.50	10.1	10.6	10.94	11.24	11.54	11.84	12.14	12.44	12.74	13.04	13.34	13.64	13.94	14.24
4.8	2.51	3.50	4.26	4.91	5.47	5.99	6.90	7.71	8.44	9.12	9.74	10.3	10.9	11.24	11.54	11.84	12.14	12.44	12.74	13.04	13.34	13.64	13.94	14.24	14.54
5.0	2.58	3.59	4.37	5.03	5.61	6.14	7.08	7.90	8.65	9.34	9.98	10.6	11.2	11.54	11.84	12.14	12.44	12.74	13.04	13.34	13.64	13.94	14.24	14.54	14.84
5.2	2.65	3.68	4.48	5.15	5.75	6.29	7.25	8.00	8.86	9.56	10.2	10.8	11.4	11.74	12.04	12.34	12.64	12.94	13.24	13.54	13.84	14.14	14.44	14.74	15.04
5.4	2.72	3.77	4.58	5.27	5.88	6.43	7.41	8.28	9.06	9.78	10.5	11.1	11.7	12.04	12.34	12.64	12.94	13.24	13.54	13.84	14.14	14.44	14.74	15.04	15.34
5.6	2.78	3.86	4.69	5.39	6.01	6.58	7.58	8.46	9.26	10.00	10.7	11.3	11.9	12.24	12.54	12.84	13.14	13.44	13.74	14.04	14.34	14.64	14.94	15.24	15.54
5.8	2.85	3.94	4.79	5.51	6.14	6.72	7.74	8.64	9.45	10.2	10.9	11.5	12.1	12.44	12.74	13.04	13.34	13.64	13.94	14.24	14.54	14.84	15.14	15.44	15.74
6.0	2.91	4.03	4.89	5.62	6.27	6.85	7.90	8.81	9.63	10.4	11.1	11.8	12.4	12.74	13.04	13.34	13.64	13.94	14.24	14.54	14.84	15.14	15.44	15.74	16.04
7.0	3.20	4.44	5.38	6.17	6.88	7.51	8.65	9.66	10.6	11.4	12.2	12.9	13.6	14.0	14.34	14.64	14.94	15.24	15.54	15.84	16.14	16.44	16.74	17.04	17.34
8.0	3.49	4.82	5.83	6.68	7.44	8.13	9.36	10.4	11.4	12.3	13.2	14.0	14.7	15.0	15.34	15.64	15.94	16.24	16.54	16.84	17.14	17.44	17.74	18.04	18.34
9.0	3.79	5.17	6.25	7.17	7.98	8.72	10.0	11.2	12.2	13.2	14.1	14.9	15.7	16.0	16.34	16.64	16.94	17.24	17.54	17.84	18.14	18.44	18.74	19.04	19.34
10.0	4.06	5.52	6.66	7.63	8.49	9.27	10.7	11.9	13.0	14.0	14.9	15.7	16.5	16.8	17.14	17.44	17.74	18.04	18.34	18.64	18.94	19.24	19.54	19.84	20.14

TABLE XLIX. VELOCITY OF WATER IN FEET PER SECOND, COEFFICIENT OF ROUGHNESS, $n = .015$

r	Area	$n = .0005$	$n = .0010$	$n = .0015$	$n = .002$	$n = .0025$	$n = .003$	$n = .004$	$n = .005$	$n = .006$	$n = .008$	$n = .010$
0.2	.16	.26	.33	.40	.44	.48	.52	.56	.60	.64	.68	.72
0.4	.29	.45	.57	.68	.77	.85	.92	1.00	1.08	1.16	1.24	1.32
0.6	.41	.63	.79	.93	1.05	1.16	1.26	1.35	1.44	1.52	1.61	1.70
0.8	.52	.79	.99	1.15	1.30	1.43	1.57	1.68	1.78	1.88	1.97	2.06
1.0	.63	.93	1.16	1.36	1.53	1.68	1.82	1.94	2.05	2.16	2.26	2.36
1.2	.72	1.07	1.33	1.55	1.74	1.92	2.07	2.20	2.32	2.44	2.56	2.68
1.4	.82	1.20	1.49	1.73	1.94	2.14	2.28	2.40	2.51	2.62	2.73	2.84
1.6	.91	1.32	1.64	1.90	2.13	2.35	2.49	2.60	2.70	2.80	2.90	3.00
1.8	.99	1.41	1.78	2.06	2.32	2.55	2.69	2.80	2.90	3.00	3.10	3.20
2.0	1.07	1.55	1.91	2.22	2.49	2.73	2.86	3.00	3.10	3.20	3.30	3.40
2.2	1.15	1.66	2.04	2.37	2.65	2.91	3.07	3.20	3.30	3.40	3.50	3.60
2.4	1.23	1.76	2.17	2.51	2.81	3.09	3.28	3.40	3.50	3.60	3.70	3.80
2.6	1.31	1.86	2.29	2.65	2.97	3.25	3.45	3.55	3.65	3.75	3.85	3.95
2.8	1.38	1.96	2.41	2.79	3.12	3.42	3.62	3.70	3.80	3.90	4.00	4.10
3.0	1.45	2.06	2.52	2.92	3.26	3.58	3.78	3.85	3.95	4.05	4.15	4.25
3.2	1.52	2.15	2.63	3.04	3.40	3.73	3.93	4.00	4.10	4.20	4.30	4.40
3.4	1.59	2.24	2.74	3.17	3.54	3.88	4.07	4.15	4.25	4.35	4.45	4.55
3.6	1.65	2.33	2.85	3.29	3.67	4.02	4.21	4.30	4.40	4.50	4.60	4.70
3.8	1.72	2.42	2.95	3.41	3.80	4.16	4.35	4.45	4.55	4.65	4.75	4.85
4.0	1.78	2.50	3.05	3.52	3.93	4.31	4.50	4.60	4.70	4.80	4.90	5.00
4.2	1.85	2.58	3.15	3.63	4.06	4.44	4.65	4.75	4.85	4.95	5.05	5.15
4.4	1.91	2.67	3.25	3.74	4.18	4.57	4.78	4.88	4.98	5.08	5.18	5.28
4.6	1.97	2.75	3.35	3.85	4.30	4.70	4.92	5.02	5.12	5.22	5.32	5.42
4.8	2.03	2.83	3.44	3.96	4.42	4.83	5.05	5.15	5.25	5.35	5.45	5.55
5.0	2.09	2.90	3.53	4.06	4.53	4.96	5.17	5.27	5.37	5.47	5.57	5.67
5.2	2.14	2.98	3.62	4.16	4.64	5.08	5.29	5.39	5.49	5.59	5.69	5.79
5.4	2.20	3.05	3.71	4.27	4.76	5.20	5.41	5.51	5.61	5.71	5.81	5.91
5.6	2.26	3.13	3.80	4.36	4.87	5.32	5.53	5.63	5.73	5.83	5.93	6.03
5.8	2.31	3.20	3.88	4.46	4.97	5.44	5.65	5.75	5.85	5.95	6.05	6.15
6.0	2.37	3.27	3.97	4.56	5.08	5.56	5.77	5.87	5.97	6.07	6.17	6.27
6.2	2.42	3.34	4.05	4.65	5.18	5.67	5.88	5.98	6.08	6.18	6.28	6.38
6.4	2.47	3.41	4.13	4.75	5.29	5.78	5.99	6.09	6.19	6.29	6.39	6.49
6.6	2.52	3.48	4.21	4.84	5.39	5.89	6.10	6.20	6.30	6.40	6.50	6.60
6.8	2.58	3.55	4.29	4.93	5.49	6.00	6.21	6.31	6.41	6.51	6.61	6.71
7.0	2.64	3.61	4.37	5.02	5.59	6.10	6.31	6.41	6.51	6.61	6.71	6.81
7.5	2.70	3.77	4.57	5.24	5.83	6.36	6.57	6.67	6.77	6.87	6.97	7.07
8.0	2.88	3.93	4.75	5.45	6.06	6.62	6.83	6.93	7.03	7.13	7.23	7.33
8.5	3.00	4.09	4.93	5.65	6.29	6.87	7.08	7.18	7.28	7.38	7.48	7.58
9.0	3.11	4.24	5.11	5.85	6.51	7.10	7.31	7.41	7.51	7.61	7.71	7.81
9.5	3.23	4.39	5.28	6.05	6.73	7.34	7.55	7.65	7.75	7.85	7.95	8.05
10	3.31	4.53	5.45	6.24	6.94	7.57	7.78	7.88	7.98	8.08	8.18	8.28

TABLE I. VELOCITY OF WATER IN FEET PER SECOND, COEFFICIENT OF ROUGHNESS, $n = .020$

$f = \frac{\text{area}}{\text{wet per.}}$	$R = .264$ $S = .00095$	$R = .528$ $S = .00010$	$R = .792$ $S = .00015$	$R = 1.056$ $S = .0002$	$R = 1.320$ $S = .00025$	$R = 1.584$ $S = .0003$	$R = 2.112$ $S = .0004$	$R = 2.640$ $S = .0005$	$R = 3.168$ $S = .0006$	$R = 3.696$ $S = .0007$	$R = 4.224$ $S = .0008$	$R = 4.752$ $S = .0009$	$R = 5.280$ $S = .0010$	$R = 7.92$ $S = .0015$	$R = 10.56$ $S = .002$	$R = 15.84$ $S = .003$	$R = 21.12$ $S = .004$	$R = 26.40$ $S = .005$	$R = 31.68$ $S = .006$	$R = 42.24$ $S = .008$	$R = 52.80$ $S = .010$
0.2	.11	.17	.22	.27	.30	.33	.36	.44	.53	.57	.61	.65	.69	.72	.76	.80	.84	.88	.92	.96	1.00
0.4	.21	.32	.41	.56	.66	.74	.82	.96	1.08	1.18	1.28	1.37	1.46	1.52	1.59	1.66	1.72	1.78	1.84	1.90	1.96
0.6	.29	.44	.56	.82	.96	1.08	1.21	1.41	1.55	1.67	1.78	1.88	1.98	2.06	2.14	2.22	2.29	2.36	2.43	2.50	2.57
0.8	.37	.56	.70	.98	1.10	1.21	1.35	1.59	1.74	1.88	2.02	2.14	2.26	2.35	2.43	2.50	2.57	2.64	2.71	2.78	2.85
1.0	.45	.67	.84	.98	1.10	1.21	1.41	1.59	1.74	1.88	2.02	2.14	2.26	2.35	2.43	2.50	2.57	2.64	2.71	2.78	2.85
1.2	.52	.77	.96	1.12	1.26	1.39	1.62	1.81	1.99	2.15	2.31	2.45	2.58	2.74	2.88	3.01	3.17	3.31	3.45	3.58	3.72
1.4	.59	.87	1.08	1.41	1.56	1.72	1.99	2.23	2.41	2.58	2.74	2.88	3.01	3.17	3.31	3.45	3.58	3.72	3.85	3.99	4.12
1.6	.66	.96	1.20	1.39	1.56	1.72	1.99	2.23	2.45	2.65	2.83	3.01	3.17	3.31	3.45	3.58	3.72	3.85	3.99	4.12	4.25
1.8	.73	1.05	1.30	1.52	1.70	1.87	2.17	2.43	2.66	2.88	3.08	3.27	3.45	3.62	3.78	3.94	4.10	4.25	4.40	4.55	4.70
2.0	.79	1.14	1.41	1.64	1.84	2.01	2.33	2.61	2.86	3.10	3.31	3.52	3.71	4.55	5.26	6.44	7.44	8.31	9.11	10.5	11.8
2.2	.85	1.23	1.51	1.75	1.96	2.16	2.49	2.79	3.06	3.31	3.54	3.76	3.96	4.85	5.61	6.87	7.94	8.87	9.72	11.2	12.6
2.4	.91	1.31	1.61	1.86	2.09	2.29	2.65	2.97	3.25	3.51	3.75	3.99	4.20	5.15	5.95	7.20	8.42	9.41	10.3	11.9	13.3
2.6	.97	1.40	1.70	1.97	2.21	2.42	2.80	3.13	3.43	3.71	3.97	4.21	4.44	5.44	6.28	7.70	8.92	9.94	10.9	12.5	14.0
2.8	1.03	1.46	1.80	2.08	2.33	2.55	2.95	3.30	3.61	3.90	4.17	4.43	4.67	5.72	6.60	8.00	9.35	10.4	11.4	13.2	14.8
3.0	1.09	1.54	1.89	2.18	2.44	2.68	3.09	3.45	3.78	4.09	4.37	4.64	4.89	5.99	6.91	8.47	9.78	10.9	12.0	14.0	15.5
3.2	1.14	1.61	1.97	2.28	2.55	2.79	3.23	3.61	3.95	4.27	4.56	4.84	5.10	6.25	7.22	8.84	10.2	11.4	12.5	14.4	16.1
3.4	1.19	1.68	2.06	2.38	2.66	2.91	3.36	3.76	4.11	4.44	4.75	5.04	5.31	6.50	7.51	9.20	10.6	11.9	13.0	15.0	16.8
3.6	1.25	1.75	2.14	2.47	2.76	3.03	3.49	3.90	4.27	4.62	4.93	5.23	5.52	6.75	7.80	9.55	11.0	12.3	13.5	15.6	17.4
3.8	1.30	1.82	2.23	2.57	2.87	3.14	3.62	4.05	4.43	4.78	5.11	5.42	5.72	7.00	8.08	9.80	11.4	12.8	14.0	16.2	18.1
4.0	1.35	1.89	2.31	2.66	2.97	3.25	3.75	4.19	4.58	4.95	5.29	5.61	5.91	7.24	8.36	10.2	11.8	13.2	14.5	16.7	18.7
4.2	1.40	1.96	2.38	2.75	3.07	3.36	3.87	4.32	4.73	5.11	5.46	5.79	6.10	7.47	8.62	10.6	12.2	13.6	14.9	17.2	19.3
4.4	1.45	2.02	2.40	2.83	3.16	3.46	3.99	4.46	4.88	5.27	5.63	5.97	6.29	7.70	8.89	10.9	12.6	14.1	15.4	17.8	19.8
4.6	1.50	2.08	2.54	2.92	3.26	3.56	4.11	4.59	5.02	5.42	5.79	6.14	6.47	7.92	9.14	11.2	12.9	14.5	15.8	18.3	20.4
4.8	1.54	2.15	2.61	3.00	3.35	3.66	4.22	4.72	5.10	5.52	5.96	6.31	6.65	8.14	9.40	11.5	13.3	14.9	16.3	18.8	21.0
5.0	1.59	2.21	2.68	3.09	3.44	3.76	4.34	4.84	5.30	5.72	6.12	6.48	6.83	8.36	9.65	11.8	13.6	15.2	16.7	19.3	21.5
5.2	1.63	2.27	2.76	3.17	3.53	3.86	4.45	4.97	5.44	5.87	6.27	6.65	7.00	8.57	9.89	12.1	14.0	15.6	17.1	19.8	22.1
5.4	1.68	2.33	2.85	3.25	3.62	3.96	4.56	5.09	5.57	6.01	6.42	6.81	7.18	8.78	10.1	12.4	14.3	16.0	17.5	20.2	22.6
5.6	1.73	2.39	2.90	3.33	3.71	4.05	4.67	5.21	5.70	6.15	6.57	6.97	7.34	8.98	10.4	12.7	14.7	16.4	18.0	20.7	23.2
5.8	1.77	2.45	2.97	3.41	3.80	4.15	4.78	5.33	5.83	6.29	6.72	7.13	7.51	9.19	10.6	13.0	15.0	16.7	18.3	21.2	23.7
6.0	1.82	2.51	3.03	3.48	3.88	4.24	4.88	5.45	5.95	6.43	6.87	7.28	7.67	9.38	10.8	13.3	15.3	17.1	18.7	21.6	24.2
7.0	2.03	2.70	3.36	3.86	4.29	4.68	5.40	6.01	6.57	7.10	7.57	8.02	8.45	10.4	11.9	14.6	16.8	18.8	20.6	23.8	26.6
8.0	2.23	3.04	3.66	4.20	4.67	5.10	5.86	6.53	7.14	7.71	8.23	8.72	9.10	11.2	13.0	15.9	18.3	20.5	22.4	25.9	28.9
9.0	2.42	3.28	3.95	4.52	5.03	5.49	6.31	7.03	7.68	8.29	8.85	9.36	9.87	12.1	14.0	17.0	19.7	22.0	24.1	27.8	31.1
10	2.60	3.52	4.23	4.83	5.37	5.86	6.73	7.50	8.20	8.84	9.44	10.0	10.5	12.9	14.9	18.2	21.0	23.4	25.7	29.6	33.1

TABLE LI. VELOCITY OF WATER IN FEET PER SECOND, COEFFICIENT OF ROUGHNESS, $n = .0235$

r	$F = .792$ $n = .0015$	$F = 1.056$ $n = .0020$	$F = 1.320$ $n = .0025$	$F = 1.584$ $n = .0030$	$F = 2.112$ $n = .0040$	$F = 2.640$ $n = .0050$	$F = 3.168$ $n = .0060$	$F = 3.696$ $n = .0070$	$F = 4.224$ $n = .0080$	$F = 4.752$ $n = .0090$	$F = 5.280$ $n = .0100$	$F = 7.92$ $n = .0015$	$F = 10.56$ $n = .0020$	$F = 15.84$ $n = .0030$	$F = 21.12$ $n = .0040$	$F = 26.40$ $n = .0050$	$F = 31.68$ $n = .0060$	$F = 42.24$ $n = .0080$	$F = 52.80$ $n = .0100$
0.2	10	23	29	34	40	45	52	58	66	72	79	97	130	178	244	324	422	528	
0.4	18	35	41	46	51	56	61	67	74	80	86	105	140	190	255	336	444	576	
0.6	25	49	57	64	71	78	83	89	96	102	109	132	175	235	312	408	536	704	
0.8	33	65	77	85	93	101	107	114	121	128	135	162	215	285	372	480	616	804	
1.0	39	79	94	103	112	120	126	133	140	147	154	186	245	321	416	536	688	900	
1.4	46	94	112	122	131	139	145	152	159	166	173	210	275	357	464	596	760	1000	
1.8	52	105	125	136	145	153	159	166	173	180	187	228	298	388	504	648	832	1100	
2.0	58	115	137	148	157	165	171	178	185	192	199	244	318	412	536	696	900	1200	
2.2	61	122	145	156	165	173	179	186	193	200	207	254	332	432	564	732	960	1300	
2.4	64	128	152	163	172	180	186	193	200	207	214	264	348	456	596	780	1024	1400	
2.6	67	133	158	169	178	186	192	199	206	213	220	272	360	472	616	816	1080	1500	
2.8	70	139	165	176	185	193	199	206	213	220	227	280	372	488	640	856	1140	1600	
3.0	73	144	172	183	192	200	206	213	220	227	234	288	384	504	664	896	1200	1700	
3.2	75	148	179	190	199	207	213	220	227	234	241	296	396	520	688	936	1260	1800	
3.4	77	152	185	196	205	213	219	226	233	240	247	304	408	536	712	960	1320	1900	
3.6	79	156	191	202	211	219	225	232	239	246	253	312	420	552	744	1008	1380	2000	
3.8	81	160	197	208	217	225	231	238	245	252	259	320	432	576	784	1056	1440	2100	
4.0	83	164	203	214	223	231	237	244	251	258	265	328	444	600	816	1104	1500	2200	
4.2	85	168	209	220	229	237	243	250	257	264	271	336	456	624	856	1152	1560	2300	
4.4	87	172	215	226	235	243	249	256	263	270	277	344	468	648	896	1200	1620	2400	
4.6	89	176	221	232	241	249	255	262	269	276	283	352	480	672	944	1260	1680	2500	
4.8	91	180	227	238	247	255	261	268	275	282	289	360	492	700	992	1320	1740	2600	
5.0	93	184	233	244	253	261	267	274	281	288	295	368	504	728	1040	1380	1800	2700	
5.2	95	188	239	250	259	267	273	280	287	294	301	376	516	756	1096	1440	1860	2800	
5.4	97	192	245	256	265	273	279	286	293	300	307	384	528	784	1152	1500	1920	2900	
5.6	99	196	251	262	271	279	285	292	299	306	313	392	540	812	1208	1560	2000	3000	
5.8	101	200	257	268	277	285	291	298	305	312	319	400	552	840	1264	1620	2080	3100	
6.0	103	204	263	274	283	291	297	304	311	318	325	408	564	868	1320	1680	2160	3200	
7.0	112	220	280	292	301	309	315	322	329	336	343	432	584	944	1440	1800	2400	3600	
8.0	120	236	298	310	319	327	333	340	347	354	361	456	616	1040	1600	2000	2700	4000	
9.0	128	252	316	328	337	345	351	358	365	372	379	480	648	1120	1720	2160	2900	4500	
10	136	268	334	346	355	363	369	376	383	390	397	504	680	1200	1840	2320	3100	5000	

VELOCITY TABLES

TABLE LII. VELOCITY OF WATER IN FEET PER SECOND, COEFFICIENT OF ROUGHNESS, n = .025

Area wet per.	R = .264 S = .00005	R = .528 S = .00010	R = .792 S = .00015	R = 1.056 S = .00020	R = 1.320 S = .00025	R = 1.584 S = .0003	R = 2.112 S = .0004	R = 2.640 S = .0005	R = 3.168 S = .0006	R = 3.696 S = .0007	R = 4.224 S = .0008	R = 4.752 S = .0009	R = 5.280 S = .0010	R = 5.808 S = .0015	R = 6.336 S = .002	R = 6.864 S = .003	R = 7.392 S = .004	R = 7.920 S = .005	R = 8.448 S = .006	R = 8.976 S = .008	R = 9.504 S = .010
0.2	.08	.13	.17	.20	.22	.25	.29	.33	.36	.39	.42	.45	.48	.50	.68	.83	.97	1.08	1.18	1.37	1.53
0.4	.10	.14	.18	.21	.23	.26	.30	.34	.37	.40	.43	.46	.49	.51	.70	.85	1.00	1.12	1.22	1.41	1.57
0.7	.13	.17	.22	.26	.29	.33	.37	.41	.44	.47	.50	.53	.56	.58	.78	.93	1.08	1.20	1.29	1.48	1.64
1.0	.15	.19	.24	.28	.31	.35	.39	.43	.46	.49	.52	.55	.58	.60	.80	.95	1.10	1.22	1.31	1.50	1.66
1.2	.16	.20	.25	.29	.32	.36	.40	.44	.47	.50	.53	.56	.59	.61	.81	.96	1.11	1.23	1.32	1.51	1.67
1.4	.17	.21	.26	.30	.33	.37	.41	.45	.48	.51	.54	.57	.60	.62	.82	.97	1.12	1.24	1.33	1.52	1.68
1.6	.18	.22	.27	.31	.34	.38	.42	.46	.49	.52	.55	.58	.61	.63	.83	.98	1.13	1.25	1.34	1.53	1.69
1.8	.19	.23	.28	.32	.35	.39	.43	.47	.50	.53	.56	.59	.62	.64	.84	.99	1.14	1.26	1.35	1.54	1.70
2.0	.20	.24	.29	.33	.36	.40	.44	.48	.51	.54	.57	.60	.63	.65	.85	1.00	1.15	1.27	1.36	1.55	1.71
2.2	.21	.25	.30	.34	.37	.41	.45	.49	.52	.55	.58	.61	.64	.66	.86	1.01	1.16	1.28	1.37	1.56	1.72
2.4	.22	.26	.31	.35	.38	.42	.46	.50	.53	.56	.59	.62	.65	.67	.87	1.02	1.17	1.29	1.38	1.57	1.73
2.6	.23	.27	.32	.36	.39	.43	.47	.51	.54	.57	.60	.63	.66	.68	.88	1.03	1.18	1.30	1.39	1.58	1.74
2.8	.24	.28	.33	.37	.40	.44	.48	.52	.55	.58	.61	.64	.67	.69	.89	1.04	1.19	1.31	1.40	1.59	1.75
3.0	.25	.29	.34	.38	.41	.45	.49	.53	.56	.59	.62	.65	.68	.70	.90	1.05	1.20	1.32	1.41	1.60	1.76
3.2	.26	.30	.35	.39	.42	.46	.50	.54	.57	.60	.63	.66	.69	.71	.91	1.06	1.21	1.33	1.42	1.61	1.77
3.4	.27	.31	.36	.40	.43	.47	.51	.55	.58	.61	.64	.67	.70	.72	.92	1.07	1.22	1.34	1.43	1.62	1.78
3.6	.28	.32	.37	.41	.44	.48	.52	.56	.59	.62	.65	.68	.71	.73	.93	1.08	1.23	1.35	1.44	1.63	1.79
3.8	.29	.33	.38	.42	.45	.49	.53	.57	.60	.63	.66	.69	.72	.74	.94	1.09	1.24	1.36	1.45	1.64	1.80
4.0	.30	.34	.39	.43	.46	.50	.54	.58	.61	.64	.67	.70	.73	.75	.95	1.10	1.25	1.37	1.46	1.65	1.81
4.2	.31	.35	.40	.44	.47	.51	.55	.59	.62	.65	.68	.71	.74	.76	.96	1.11	1.26	1.38	1.47	1.66	1.82
4.4	.32	.36	.41	.45	.48	.52	.56	.60	.63	.66	.69	.72	.75	.77	.97	1.12	1.27	1.39	1.48	1.67	1.83
4.6	.33	.37	.42	.46	.49	.53	.57	.61	.64	.67	.70	.73	.76	.78	.98	1.13	1.28	1.40	1.49	1.68	1.84
4.8	.34	.38	.43	.47	.50	.54	.58	.62	.65	.68	.71	.74	.77	.79	.99	1.14	1.29	1.41	1.50	1.69	1.85
5.0	.35	.39	.44	.48	.51	.55	.59	.63	.66	.69	.72	.75	.78	.80	1.00	1.15	1.30	1.42	1.51	1.70	1.86
5.2	.36	.40	.45	.49	.52	.56	.60	.64	.67	.70	.73	.76	.79	.81	1.01	1.16	1.31	1.43	1.52	1.71	1.87
5.4	.37	.41	.46	.50	.53	.57	.61	.65	.68	.71	.74	.77	.80	.82	1.02	1.17	1.32	1.44	1.53	1.72	1.88
5.6	.38	.42	.47	.51	.54	.58	.62	.66	.69	.72	.75	.78	.81	.83	1.03	1.18	1.33	1.45	1.54	1.73	1.89
5.8	.39	.43	.48	.52	.55	.59	.63	.67	.70	.73	.76	.79	.82	.84	1.04	1.19	1.34	1.46	1.55	1.74	1.90
6.0	.40	.44	.49	.53	.56	.60	.64	.68	.71	.74	.77	.80	.83	.85	1.05	1.20	1.35	1.47	1.56	1.75	1.91
7.0	.45	.50	.55	.60	.63	.67	.71	.75	.78	.81	.84	.87	.90	.92	1.12	1.27	1.42	1.54	1.63	1.82	1.98
8.0	.50	.55	.60	.65	.68	.72	.76	.80	.83	.86	.89	.92	.95	.97	1.17	1.32	1.47	1.59	1.68	1.87	2.03
10.0	.55	.60	.65	.70	.73	.77	.81	.84	.87	.90	.93	.96	.99	1.01	1.21	1.36	1.51	1.63	1.72	1.91	2.07
11.0	.57	.62	.67	.72	.75	.79	.83	.86	.89	.92	.95	.98	1.01	1.03	1.23	1.38	1.53	1.65	1.74	1.93	2.09
12.0	.59	.64	.69	.74	.77	.81	.85	.88	.91	.94	.97	1.00	1.03	1.05	1.25	1.40	1.55	1.67	1.76	1.95	2.11

TABLE LIII. VELOCITY OF WATER IN FEET PER SECOND, COEFFICIENT OF ROUGHNESS, $n = .030$

r	area	$r = .264$ $S = .00005$	$r = .538$ $S = .00010$	$r = .792$ $S = .00015$	$r = 1.056$ $S = .00020$	$r = 1.320$ $S = .00025$	$r = 1.584$ $S = .0003$	$r = 2.112$ $S = .0004$	$r = 2.640$ $S = .0005$	$r = 3.168$ $S = .0006$	$r = 3.696$ $S = .0007$	$r = 4.224$ $S = .0008$	$r = 4.752$ $S = .0009$	$r = 5.280$ $S = .0010$	$r = 5.808$ $S = .0015$	$r = 6.336$ $S = .002$	$r = 6.864$ $S = .003$	$r = 7.392$ $S = .004$	$r = 7.920$ $S = .005$	$r = 8.448$ $S = .006$	$r = 8.976$ $S = .008$	$r = 9.504$ $S = .010$	
0.2	10	1.13	1.16	1.23	1.31	1.33	1.35	1.37	1.40	1.42	1.44	1.46	1.48	1.50	1.52	1.54	1.56	1.58	1.60	1.62	1.64	1.66	1.68
0.4	11	1.19	1.24	1.32	1.41	1.43	1.45	1.47	1.50	1.52	1.54	1.56	1.58	1.60	1.62	1.64	1.66	1.68	1.70	1.72	1.74	1.76	1.78
0.6	12	1.24	1.31	1.40	1.50	1.52	1.54	1.56	1.59	1.62	1.64	1.66	1.68	1.70	1.72	1.74	1.76	1.78	1.80	1.82	1.84	1.86	1.88
0.8	13	1.29	1.37	1.47	1.58	1.60	1.62	1.64	1.67	1.70	1.72	1.74	1.76	1.78	1.80	1.82	1.84	1.86	1.88	1.90	1.92	1.94	1.96
1.0	14	1.34	1.43	1.54	1.66	1.68	1.70	1.72	1.75	1.78	1.80	1.82	1.84	1.86	1.88	1.90	1.92	1.94	1.96	1.98	2.00	2.02	2.04
1.2	15	1.39	1.49	1.61	1.74	1.76	1.78	1.80	1.83	1.86	1.88	1.90	1.92	1.94	1.96	1.98	2.00	2.02	2.04	2.06	2.08	2.10	2.12
1.4	16	1.44	1.55	1.68	1.82	1.84	1.86	1.88	1.91	1.94	1.96	1.98	2.00	2.02	2.04	2.06	2.08	2.10	2.12	2.14	2.16	2.18	2.20
1.6	17	1.49	1.61	1.75	1.90	1.92	1.94	1.96	1.99	2.02	2.04	2.06	2.08	2.10	2.12	2.14	2.16	2.18	2.20	2.22	2.24	2.26	2.28
1.8	18	1.54	1.67	1.82	1.98	2.00	2.02	2.04	2.07	2.10	2.12	2.14	2.16	2.18	2.20	2.22	2.24	2.26	2.28	2.30	2.32	2.34	2.36
2.0	19	1.59	1.73	1.89	2.06	2.08	2.10	2.12	2.15	2.18	2.20	2.22	2.24	2.26	2.28	2.30	2.32	2.34	2.36	2.38	2.40	2.42	2.44
2.2	20	1.64	1.79	1.96	2.14	2.16	2.18	2.20	2.23	2.26	2.28	2.30	2.32	2.34	2.36	2.38	2.40	2.42	2.44	2.46	2.48	2.50	2.52
2.4	21	1.69	1.85	2.03	2.22	2.24	2.26	2.28	2.31	2.34	2.36	2.38	2.40	2.42	2.44	2.46	2.48	2.50	2.52	2.54	2.56	2.58	2.60
2.6	22	1.74	1.91	2.10	2.30	2.32	2.34	2.36	2.39	2.42	2.44	2.46	2.48	2.50	2.52	2.54	2.56	2.58	2.60	2.62	2.64	2.66	2.68
2.8	23	1.79	1.97	2.17	2.38	2.40	2.42	2.44	2.47	2.50	2.52	2.54	2.56	2.58	2.60	2.62	2.64	2.66	2.68	2.70	2.72	2.74	2.76
3.0	24	1.84	2.03	2.24	2.46	2.48	2.50	2.52	2.55	2.58	2.60	2.62	2.64	2.66	2.68	2.70	2.72	2.74	2.76	2.78	2.80	2.82	2.84
3.2	25	1.89	2.09	2.31	2.54	2.56	2.58	2.60	2.63	2.66	2.68	2.70	2.72	2.74	2.76	2.78	2.80	2.82	2.84	2.86	2.88	2.90	2.92
3.4	26	1.94	2.15	2.38	2.62	2.64	2.66	2.68	2.71	2.74	2.76	2.78	2.80	2.82	2.84	2.86	2.88	2.90	2.92	2.94	2.96	2.98	3.00
3.6	27	1.99	2.21	2.45	2.70	2.72	2.74	2.76	2.79	2.82	2.84	2.86	2.88	2.90	2.92	2.94	2.96	2.98	3.00	3.02	3.04	3.06	3.08
3.8	28	2.04	2.27	2.52	2.78	2.80	2.82	2.84	2.87	2.90	2.92	2.94	2.96	2.98	3.00	3.02	3.04	3.06	3.08	3.10	3.12	3.14	3.16
4.0	29	2.09	2.33	2.59	2.86	2.88	2.90	2.92	2.95	2.98	3.00	3.02	3.04	3.06	3.08	3.10	3.12	3.14	3.16	3.18	3.20	3.22	3.24
4.2	30	2.14	2.39	2.66	2.94	2.96	2.98	3.00	3.03	3.06	3.08	3.10	3.12	3.14	3.16	3.18	3.20	3.22	3.24	3.26	3.28	3.30	3.32
4.4	31	2.19	2.45	2.73	3.02	3.04	3.06	3.08	3.11	3.14	3.16	3.18	3.20	3.22	3.24	3.26	3.28	3.30	3.32	3.34	3.36	3.38	3.40
4.6	32	2.24	2.51	2.80	3.10	3.12	3.14	3.16	3.19	3.22	3.24	3.26	3.28	3.30	3.32	3.34	3.36	3.38	3.40	3.42	3.44	3.46	3.48
4.8	33	2.29	2.57	2.87	3.18	3.20	3.22	3.24	3.27	3.30	3.32	3.34	3.36	3.38	3.40	3.42	3.44	3.46	3.48	3.50	3.52	3.54	3.56
5.0	34	2.34	2.63	2.94	3.26	3.28	3.30	3.32	3.35	3.38	3.40	3.42	3.44	3.46	3.48	3.50	3.52	3.54	3.56	3.58	3.60	3.62	3.64
5.2	35	2.39	2.69	3.01	3.34	3.36	3.38	3.40	3.43	3.46	3.48	3.50	3.52	3.54	3.56	3.58	3.60	3.62	3.64	3.66	3.68	3.70	3.72
5.4	36	2.44	2.75	3.08	3.42	3.44	3.46	3.48	3.51	3.54	3.56	3.58	3.60	3.62	3.64	3.66	3.68	3.70	3.72	3.74	3.76	3.78	3.80
5.6	37	2.49	2.81	3.15	3.50	3.52	3.54	3.56	3.59	3.62	3.64	3.66	3.68	3.70	3.72	3.74	3.76	3.78	3.80	3.82	3.84	3.86	3.88
5.8	38	2.54	2.87	3.22	3.58	3.60	3.62	3.64	3.67	3.70	3.72	3.74	3.76	3.78	3.80	3.82	3.84	3.86	3.88	3.90	3.92	3.94	3.96
6.0	39	2.59	2.93	3.29	3.66	3.68	3.70	3.72	3.75	3.78	3.80	3.82	3.84	3.86	3.88	3.90	3.92	3.94	3.96	3.98	4.00	4.02	4.04
7.0	40	2.69	3.05	3.42	3.80	3.82	3.84	3.86	3.89	3.92	3.94	3.96	3.98	4.00	4.02	4.04	4.06	4.08	4.10	4.12	4.14	4.16	4.18
8.0	41	2.79	3.17	3.56	3.96	3.98	4.00	4.02	4.05	4.08	4.10	4.12	4.14	4.16	4.18	4.20	4.22	4.24	4.26	4.28	4.30	4.32	4.34
9.0	42	2.89	3.29	3.70	4.12	4.14	4.16	4.18	4.21	4.24	4.26	4.28	4.30	4.32	4.34	4.36	4.38	4.40	4.42	4.44	4.46	4.48	4.50
10	43	2.99	3.41	3.84	4.28	4.30	4.32	4.34	4.37	4.40	4.42	4.44	4.46	4.48	4.50	4.52	4.54	4.56	4.58	4.60	4.62	4.64	4.66

VELOCITY TABLES

TABLE LIV.—AREA IN SQUARE FEET, A, AND HYDRAULIC RADIUS, r, OF TRAPEZOIDAL CHANNELS, SIDE SLOPES 2 : 1

Depth.	BOTTOM WIDTH IN FEET.												
	4	6	8	10	12	14	16	18	20	25	30	40	50
1.0	A 6.0	8.0	10.0	12.0	14.0	16.0	18.0	20.0	22.0	27.0	32.0	42.0	52.0
	r .71	.76	.80	.83	.85	.87	.88	.89	.90	.92	.93	.94	.95
1.5	A 10.5	13.5	16.5	19.5	22.5	25.5	28.5	31.5	34.5	42.0	49.5	64.5	79.5
	r .98	1.06	1.12	1.16	1.22	1.23	1.25	1.28	1.30	1.32	1.35	1.38	1.40
2.0	A 16.0	20.0	24.0	28.0	32.0	36.0	40.0	44.0	48.0	58.0	68.0	88.0	108
	r 1.24	1.33	1.41	1.48	1.52	1.57	1.60	1.63	1.66	1.71	1.75	1.80	1.83
2.5	A 22.5	27.5	32.5	37.5	42.5	47.5	52.5	57.5	62.5	75.0	87.5	113	138
	r 1.48	1.60	1.70	1.77	1.83	1.88	1.93	1.97	2.00	2.07	2.12	2.20	2.25
3.0	A 30.0	36.0	42.0	48.0	54.0	60.0	66.0	72.0	78.0	93.0	108	138	168
	r 1.72	1.85	1.96	2.05	2.12	2.19	2.24	2.29	2.34	2.42	2.48	2.58	2.65
3.5	A 38.5	45.5	52.5	59.5	66.5	73.5	80.5	87.5	94.5	112	130	165	200
	r 1.96	2.10	2.22	2.32	2.40	2.48	2.54	2.60	2.65	2.82	2.84	2.96	3.04
4.0	A 48.0	56.0	64.0	72.0	80.0	88.0	96.0	104	112	132	152	192	232
	r 2.19	2.34	2.47	2.58	2.68	2.76	2.83	2.90	2.96	3.08	3.17	3.32	3.42
4.5	A 58.5	67.5	76.5	85.5	94.5	104	113	122	131	153	176	221	266
	r 2.42	2.58	2.72	2.84	2.94	3.04	3.11	3.18	3.25	3.39	3.50	3.67	3.78
5.0	A 70.0	80.0	90.0	100	110	120	130	140	150	175	200	250	300
	r 2.65	2.82	2.96	3.09	3.20	3.30	3.39	3.47	3.54	3.70	3.82	4.01	4.15
5.5	A 82.5	93.5	105	116	127	138	149	160	171	198	226	281	335
	r 2.89	3.06	3.21	3.34	3.46	3.56	3.66	3.75	3.82	3.99	4.13	4.34	4.50
6.0	A 96.0	108	120	132	144	156	168	180	192	222	252	312	372
	r 3.11	3.29	3.45	3.59	3.71	3.82	3.93	4.02	4.10	4.28	4.43	4.67	4.85
6.5	A 111	124	137	148	163	176	189	202	215	247	280	345	410
	r 3.34	3.52	3.68	3.84	3.96	4.08	4.18	4.28	4.38	4.57	4.73	4.98	5.18
7.0	A 126	140	154	168	182	196	210	224	238	273	308	378	448
	r 3.57	3.75	3.92	4.07	4.20	4.33	4.44	4.54	4.64	4.85	5.02	5.30	5.51
7.5	A 142	158	172	188	202	218	232	248	262	300	338	412	488
	r 3.80	3.98	4.15	4.31	4.45	4.58	4.69	4.80	4.90	5.12	5.31	5.61	5.84
8.0	A 160	176	192	208	224	240	256	272	288	328	368	448	528
	r 4.02	4.21	4.39	4.54	4.69	4.82	4.94	5.05	5.16	5.40	5.59	5.91	6.16
8.5	A 178	195	212	230	246	264	280	298	314	357	400	484	570
	r 4.25	4.44	4.62	4.78	4.93	5.07	5.19	5.31	5.42	5.66	5.87	6.21	6.47
9.0	A 198	216	234	252	270	288	306	324	342	387	432	522	612
	r 4.47	4.67	4.85	5.01	5.17	5.31	5.44	5.56	5.68	5.93	6.15	6.51	6.78
10.0	A 240	260	280	300	320	340	360	380	400	450	500	600	700
	r 4.93	5.13	5.31	5.48	5.64	5.80	5.94	6.06	6.18	6.45	6.69	7.09	7.40

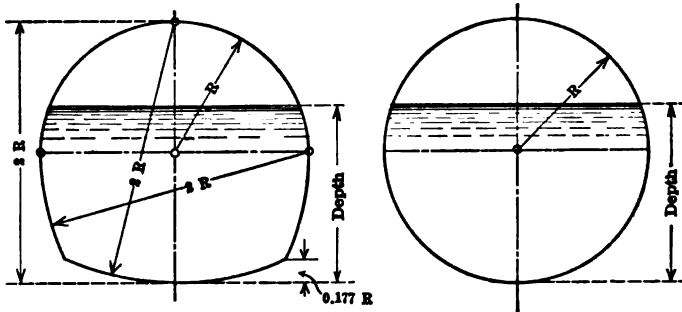

FIG. 250.—Standard Horseshoe and Circular Sections for Conduits.

TABLE LV. AREA, WETTED PERIMETER AND HYDRAULIC RADIUS OF PARTIALLY FILLED HORSESHOE AND CIRCULAR CONDUIT SECTIONS

HORSESHOE SECTIONS				CIRCULAR SECTIONS			
Depth. R	Area R^2	Wet. per. R	Hyd. rad. R	Depth. R	Area. R^2	Wet. per. R	Hyd. rad. R
0.1	0.0887	1.2702	0.0066	0.1	0.0587	0.9020	0.0561
0.177	0.1961	1.6962	0.1156	0.2	0.1635	1.2870	0.1270
0.2	0.2340	1.7462	0.1340	0.3	0.2955	1.5908	0.1858
0.3	0.4050	1.9620	0.2064	0.4	0.4473	1.8546	0.2413
0.4	0.5828	2.1736	0.2681	0.5	0.6142	2.0944	0.2936
0.5	0.7656	2.3816	0.3230	0.6	0.7927	2.3186	0.3419
0.6	0.9573	2.5869	0.3700	0.7	0.9799	2.5322	0.3870
0.7	1.1510	2.7900	0.4126	0.8	1.1735	2.7389	0.4285
0.8	1.3478	2.9916	0.4505	0.9	1.3711	2.9412	0.4662
0.9	1.5467	3.1922	0.4845	1.0	1.5708	3.1416	0.5000
1.0	1.7465	3.3923	0.5148	1.1	1.7705	3.3419	0.5298
1.1	1.9462	3.5926	0.5417	1.2	1.9681	3.5443	0.5553
1.2	2.1438	3.7949	0.5649	1.3	2.1617	3.7510	0.5763
1.3	2.3374	4.0017	0.5841	1.4	2.3489	3.9646	0.5925
1.4	2.5246	4.2153	0.5989	1.5	2.5274	4.1888	0.6034
1.5	2.7031	4.4395	0.6089	1.6	2.6943	4.4286	0.6084
1.6	2.8700	4.6793	0.6134	1.7	2.8461	4.6924	0.6065
1.7	3.0218	4.9431	0.6113	1.8	2.9781	4.9962	0.5961
1.8	3.1538	5.2409	0.6011	1.9	3.0829	5.3811	0.5729
1.9	3.2586	5.6318	0.5786	2.0	3.1416	6.2832	0.5000
2.0	3.3173	6.5339	0.5077				

NOTE.—Figures in first, third and fourth columns are to be multiplied, by adopted value of R . Figures in second column, by R^2 .

VELOCITY TABLES

TABLE LVI. AREA IN SQUARE FEET, *A*, AND HYDRAULIC RADIUS IN FEET, *r*, OF SEMI-CIRCULAR FLUMES FOR VARIOUS VALUES OF FREE-BOARD IN FEET, *F*

Flume No.	Diameter in Feet	<i>F</i> = 0.2		<i>F</i> = 0.3		<i>F</i> = 0.4		<i>F</i> = 0.5		<i>F</i> = 0.6	
		<i>A</i>	<i>r</i>	<i>A</i>	<i>r</i>	<i>A</i>	<i>r</i>	<i>A</i>	<i>r</i>	<i>A</i>	<i>r</i>
24	1.273	0.39	0.24	0.27	0.20						
30	1.592	0.68	0.32	0.53	0.28	0.38	0.23	0.25	0.18		
36	1.910	1.05	0.41	0.87	0.36	0.69	0.32	0.52	0.27		
42	2.228	1.50	0.48	1.29	0.45	1.08	0.40	0.87	0.36	0.68	0.31
48	2.546	2.04	0.57	1.79	0.53	1.54	0.49	1.31	0.44	1.08	0.39
60	3.183	3.34	0.73	3.03	0.69	2.72	0.65	2.41	0.61	2.11	0.56
72	3.820	4.97	0.89	4.59	0.85	4.21	0.81	3.84	0.77	3.48	0.73
84	4.456	6.91	1.05	6.47	1.01	6.03	0.98	5.59	0.93	5.16	0.89
96	5.093	9.17	1.21	8.66	1.17	8.16	1.13	7.66	1.09	7.16	1.06
108	5.730	11.8	1.29	11.2	1.33	10.6	1.29	10.0	1.26	9.48	1.22
120	6.366	14.6	1.53	14.0	1.49	13.4	1.45	12.7	1.42	12.1	1.38
132	7.003	17.9	1.69	17.2	1.65	16.5	1.61	15.8	1.58	15.1	1.54
144	7.639	21.4	1.84	20.6	1.81	19.9	1.77	19.1	1.74	18.4	1.70
156	8.276	25.2	2.00	24.4	1.97	23.6	1.93	22.8	1.90	21.9	1.86
168	8.913	29.4	2.16	28.5	2.13	27.6	2.09	26.7	2.06	25.9	2.02
180	9.549	33.9	2.32	32.9	2.29	32.0	2.25	31.0	2.22	30.1	2.18
192	10.186	38.7	2.48	37.7	2.45	36.7	2.42	35.7	2.38	34.6	2.34
204	10.823	43.8	2.64	42.8	2.61	41.7	2.57	40.6	2.54	39.5	2.50
216	11.459	49.3	2.80	48.1	2.76	47.0	2.73	45.8	2.70	44.7	2.66
228	12.096	55.0	2.96	53.8	2.93	52.6	2.89	51.4	2.86	50.2	2.82
240	12.732	61.1	3.12	59.8	3.08	58.6	3.05	57.3	3.01	56.0	2.98
252	13.369	67.5	3.26	66.2	3.24	64.8	3.21	63.5	3.18	62.2	3.14

Flume No.	Diameter in Feet	<i>F</i> = 0.8		<i>F</i> = 1.0		<i>F</i> = 1.2		<i>F</i> = 1.4		<i>F</i> = 1.5	
		<i>A</i>	<i>r</i>	<i>A</i>	<i>r</i>	<i>A</i>	<i>r</i>	<i>A</i>	<i>r</i>	<i>A</i>	<i>r</i>
72	3.820	2.76	0.64	2.08	0.54						
84	4.456	4.31	0.80	3.49	0.71	2.71	0.61				
96	5.093	6.18	0.97	5.22	0.88	4.30	0.78	3.41	0.68		
108	5.730	8.37	1.14	7.28	1.05	6.22	0.96	5.19	0.86	4.69	0.81
120	6.366	10.9	1.30	9.65	1.21	8.46	1.12	7.29	1.03	6.72	0.98
132	7.003	13.7	1.46	12.4	1.38	11.0	1.29	9.72	1.20	9.07	1.15
144	7.639	16.9	1.62	15.4	1.54	13.9	1.46	12.5	1.37	11.8	1.32
156	8.276	20.3	1.79	18.7	1.70	17.1	1.62	15.5	1.53	14.8	1.49
168	8.913	24.1	1.95	22.4	1.87	20.6	1.78	18.9	1.70	18.1	1.65
180	9.549	28.2	2.11	26.3	2.03	24.5	1.95	22.6	1.86	21.7	1.82
192	10.186	32.6	2.27	30.6	2.19	28.6	2.11	26.7	2.03	25.7	1.98
204	10.823	37.4	2.43	35.2	2.35	33.1	2.27	31.0	2.19	30.0	2.14
216	11.459	42.4	2.59	40.2	2.51	37.9	2.43	35.7	2.35	34.6	2.31
228	12.096	47.8	2.75	45.4	2.67	43.0	2.60	40.7	2.52	39.5	2.47
240	12.732	53.5	2.91	51.0	2.83	48.5	2.76	46.0	2.68	44.7	2.63
252	13.369	59.4	3.07	56.9	2.99	54.2	2.92	51.6	2.84	50.3	2.80

TABLE LVII. THEORETICAL VELOCITY OF WATER IN FEET PER SECOND FOR VARIOUS HEADS

$$V = \sqrt{2gh}. \quad g = 32.16$$

Head in Ft.	0.00	0.01	0.02	0.03	0.04	0.05	0.06	0.07	0.08	0.09
0.1	2.536	2.660	2.778	2.892	3.001	3.106	3.208	3.307	3.402	3.496
0.2	3.586	3.675	3.762	3.846	3.929	4.010	4.089	4.167	4.244	4.319
0.3	4.393	4.465	4.536	4.628	4.676	4.745	4.812	4.878	4.944	5.008
0.4	5.072	5.135	5.197	5.259	5.320	5.380	5.439	5.498	5.556	5.614
0.5	5.671	5.727	5.783	5.838	5.893	5.947	6.001	6.054	6.107	6.160
0.6	6.212	6.263	6.315	6.365	6.416	6.465	6.525	6.564	6.613	6.662
0.7	6.710	6.757	6.805	6.852	6.899	6.946	6.992	7.038	7.083	7.128
0.8	7.173	7.218	7.262	7.306	7.350	7.394	7.438	7.481	7.523	7.566
0.9	7.608	7.650	7.692	7.734	7.776	7.817	7.858	7.898	7.939	7.979
1.0	8.020	8.060	8.099	8.139	8.179	8.218	8.257	8.296	8.335	8.373
1.1	8.412	8.450	8.487	8.525	8.563	8.600	8.638	8.675	8.712	8.749
1.2	8.785	8.822	8.858	8.894	8.930	8.967	9.002	9.038	9.073	9.108
1.3	9.144	9.179	9.214	9.249	9.284	9.318	9.353	9.387	9.421	9.455
1.4	9.489	9.523	9.557	9.590	9.624	9.657	9.690	9.724	9.757	9.790
1.5	9.822	9.855	9.888	9.920	9.953	9.985	10.017	10.049	10.081	10.113
1.6	10.145	10.176	10.208	10.239	10.271	10.302	10.333	10.364	10.395	10.425
1.7	10.457	10.487	10.518	10.549	10.579	10.611	10.640	10.670	10.712	10.730
1.8	10.760	10.790	10.820	10.849	10.879	10.908	10.938	10.967	10.996	11.026
1.9	11.055	11.084	11.113	11.142	11.171	11.199	11.228	11.257	11.285	11.314

Head in Ft.	0.0	0.1	0.2	0.3	0.4	0.5	0.6	0.7	0.8	0.9
2	11.3	11.6	11.9	12.2	12.4	12.7	12.9	13.2	13.4	13.7
3	13.9	14.1	14.3	14.6	14.8	15.0	15.2	15.4	15.6	15.8
4	16.0	16.2	16.4	16.6	16.8	17.0	17.2	17.4	17.6	17.8
5	17.9	18.1	18.3	18.5	18.6	18.8	19.0	19.2	19.3	19.5
6	19.6	19.8	20.0	20.1	20.3	20.5	20.6	20.8	20.9	21.1
7	21.2	21.4	21.5	21.7	21.8	22.0	22.1	22.3	22.4	22.5
8	22.7	22.8	23.0	23.1	23.3	23.4	23.5	23.7	23.8	23.9
9	24.1	24.2	24.3	24.5	24.6	24.7	24.8	25.0	25.1	25.2
10	25.4	25.5	25.6	25.7	25.9	26.0	26.1	26.2	26.4	26.5
11	26.6	26.7	26.8	27.0	27.1	27.2	27.3	27.4	27.5	27.7
12	27.8	27.9	28.0	28.1	28.2	28.4	28.5	28.6	28.7	28.8
13	28.9	29.0	29.1	29.2	29.4	29.5	29.6	29.7	29.8	29.9
14	30.0	30.1	30.2	30.3	30.4	30.5	30.6	30.7	30.9	31.0
15	31.1	31.2	31.3	31.4	31.5	31.6	31.7	31.8	31.9	32.0
16	32.1	32.2	32.3	32.4	32.5	32.6	32.7	32.8	32.9	33.0
17	33.1	33.2	33.3	33.4	33.5	33.5	33.6	33.7	33.8	33.9
18	34.0	34.1	34.2	34.3	34.4	34.5	34.6	34.7	34.8	34.9
19	35.0	35.0	35.1	35.2	35.3	35.4	35.5	35.6	35.7	35.8
20	35.9	36.0	36.0	36.1	36.2	36.3	36.4	36.5	36.6	36.7
21	36.8	36.8	36.9	37.0	37.1	37.2	37.3	37.4	37.4	37.5

TABLE LVIII. AVERAGE WEIGHT, IN POUNDS PER CUBIC FOOT, OF VARIOUS SUBSTANCES

Substance	Weight	Substance	Weight
Clay, earth and mud:		Masonry and its materials— <i>Continued.</i>	
Clay.....	122-162	Mortar, hardened.....	90-115
Earth, dry and loose.....	72-80	Sand, pure quartz, dry, loose.....	87-106
Earth, dry and shaken.....	82-92	Sand, pure quartz, dry, slightly shaken.....	92-110
Earth, dry and moderately rammed.....	90-100	Sand, pure quartz, dry, rammed.....	100-120
Earth, slightly moist, loose.....	70-76	Sand, natural, dry, loose.....	80-110
Earth, more moist, loose.....	66-68	Sand, natural, dry, shaken.....	85-125
Earth more moist, shaken.....	75-90	Sand, wet, voids full of water.....	118-128
Earth, more moist moderately rammed.....	90-100	Stone.....	135-195
Earth, as soft flowing mud.....	104-112	Stone quarried, loosely piled.....	80-110
Earth, as soft mud well pressed into a box.....	110-120	Stone, broken, loose.....	77-112
Mud, dry, close.....	80-110	Stone, broken, rammed.....	79-121
Mud, wet, moderately pressed.....	110-130		
Mud, wet, fluid.....	104-120	Metals and alloys:	
Masonry and its materials:		Brass (copper and zinc).....	487-524
Brick, best pressed.....	150	Bronze (copper and tin).....	524-537
Brick, common hard.....	125	Copper, cast.....	537-548
Brick, soft, inferior.....	100	Copper, rolled.....	548-562
Brickwork, pressed brick, fine joints.....	140	Iron and steel, cast.....	438-483
Brickwork, medium quality.....	125	Iron and steel, average.....	450
Brickwork, coarse, inferior soft bricks.....	100	Iron and steel, wrought.....	475-494
Cement, pulverized, loose.....	72-105	Iron and steel, average.....	481
Cement, pressed.....	115	Spelter or zinc.....	425-450
Cement, set.....	168-187	Tin, cast.....	450-470
Concrete, 1 : 3 : 6.....	140		
Gravel, loose.....	82-125	Woods, seasoned and dry:	
Gravel, rammed.....	90-145	Ash.....	40-53
Masonry of granite or stone of like weight:		Hemlock.....	25
Well dressed.....	165	Hickory.....	37-58
Well-scabbled rubble, 20 per cent mortar.....	154	Oak, white.....	37-56
Roughly-scabbled rubble 25 to 35 per cent mortar.....	150	Oak, red, black, etc.....	32-45
Well-scabbled dry rubble.....	138	Pine, white.....	22-31
Roughly scabbled dry rubble.....	125	Pine, yellow, northern.....	30-39
Masonry of sandstone or stone of like weight weighs about seven-eighths of the above:		Pine, yellow, southern.....	40-50
		Poplar.....	22-31
		Spruce.....	25
		Woods weigh one-fifth to one-half more green than dry; and ordinary building timber, tolerably seasoned, weighs about one-sixth more than dry timber.	

TABLE LIX. CONVENIENT EQUIVALENTS

LENGTH

1 inch = $\frac{1}{36}$ foot = .027778 yard = .00015783 mile = 2.54 centimeters.
 1 foot = 12 inches = $\frac{1}{3}$ yard = .00018939 mile = .3048 meter.
 1 yard = 36 inches = 3 feet = .00056818 mile = .9144 meter.
 1 mile = 63360 inches = 5280 feet = 1760 yards = 1.60935 kilometers.
 1 meter = 100 centimeters = .001 kilometer = 39.37 inches = 3.2808 feet = 1.0936 yards = .00062137 mile.

SURFACE

1 square inch = .006944 square foot = .0007716 square yard = .0000001594 acre = .000000-0002491 square mile = 6.45163 square centimeters.
 1 square foot = 144 square inches = $\frac{1}{9}$ square yard = .000022957 acre = .00000003587 square mile = .092903 square meters.
 1 square yard = 1296 square inches = 9 square feet = .0002066 acre = .0000003228 square mile = .83613 square meter.
 1 acre = 6272640 square inches = 43560 square feet = 4840 square yards = .0015625 square mile = 208.71 feet square = .404687 hectare.
 1 square mile = 4014489600 square inches = 27878400 square feet = 3097600 square yards = 640 acres = 259 hectares.
 1 square meter = 10000 square centimeters = .0001 hectare = .000001 square kilometer = 1550 square inches = 10.7639 square feet = 1.19598 square yards = .0002471 acre = .0000003861 square mile.

VOLUME

1 cubic inch = .004329 U. S. gallon = .0005787 cubic foot = 16.3872 cubic centimeters.
 1 U. S. gallon = 231 cubic inches = .13368 cubic foot = .00000307 acre-foot = 3.78543 liters.
 1 cubic foot = 1728 cubic inches = 7.4805 U. S. gallons = .037037 cubic yard = .000022957 acre-foot = 28.317 liters.
 1 cubic yard = 46656 cubic inches = 27 cubic feet = .00061983 acre-foot = .76456 cubic meter.
 1 acre-foot = 325851 U. S. gallons = 43560 cubic feet = 1613 $\frac{1}{3}$ cubic yards = 1233.49 cubic meters.
 1 cubic meter, stere or kiloliter = 1000000 cubic centimeters = 1000 liters = 61023.4 cubic inches = 264.17 U. S. gallons = 35.3145 cubic feet = 1.30794 cubic yards = .000810708 acre-foot.

HYDRAULICS

1 U. S. gallon of water weighs 8.34 pounds avoirdupois.
 1 cubic foot of water weighs 62.4 pounds avoirdupois.
 1 second-foot = 448.8 U. S. gallons per minute = 26929.9 U. S. gallons per hour = .646317 U. S. gallons per day.
 = 60 cubic feet per minute = 3600 cubic feet per hour = 86400 cubic feet per day = 31536000 cubic feet per year = .000214 cubic mile per year.
 = .9917 acre-inch per hour = 1.9835 acre-feet per day = 723.9669 acre-feet per year.
 = 50 miner's inches in Idaho, Kansas, Nebraska, New Mexico, North Dakota, and South Dakota = 40 miner's inches in Arizona, California, Montana, and Oregon = 38.4 miner's inches in Colorado.
 = .028317 cubic meters per second = 1.699 cubic meters per minute = 101.941 cubic meters per hour = 2446.58 cubic meters per day.
 1 cubic meter per minute = .5886 second-foot = 4.403 U. S. gallons per second = 1.1674 acre-feet per day.
 1 million gallons per day = 1.55 second-feet = 3.07 acre-feet per day = 2.629 cubic meters per minute.
 1 second-foot falling 8.81 feet = 1 horse-power.
 1 second-foot falling 10 feet = 1.135 horse-power.
 1 second-foot falling 11 feet = 1 horse-power, 80 per cent efficiency.
 1 second-foot for 1 year will cover 1 square mile 1.131 feet or 13.572 inches deep.
 1 inch deep on 1 square mile = 2323200 cubic feet = .0737 second-foot for 1 year.

MISCELLANEOUS

1 foot per second = .68 mile per hour = 1.097 kilometers per hour.

1 avoirdupois pound = 7000 grains = .4536 kilogram.

1 kilogram = 1000 grams = .001 tonne = 15432 grains = 2.2046 pounds avoirdupois.

1 atmosphere = about $\left\{ \begin{array}{l} 15 \text{ pounds per square inch.} \\ 1 \text{ ton per square foot.} \\ 1 \text{ kilogram per square centimeter.} \end{array} \right.$

Acceleration of gravity, $g = 32.16$ feet per second.

1 mil = .001 inch.

1 circular mil = $\frac{\pi}{4}(.001)^2$ or .0000007854 square inch.

1 square inch = 1273240 circular mils.

No. 10 Birmingham gage wire has a diameter of 134 mils and a cross-sectional area of 17956 circular mils.

1 horse-power = 560,4120 foot-gallons per day = 550 foot-pounds per second = 33,000 foot-pounds per minute = 198,000 foot-pounds per hour = 2545 B.T.U. per hour = 76 kilogrammeters per second = 1.27 kilogrammeters per minute = 746 watts.

1 horse-power boiler rating, requires the evaporation of 34½ pounds per hour of water at 212° F. to dry steam at the same temperature; or the expenditure of 33,317 B. T. U.; and in practice is developed by burning 3½ to 4½ pounds per hour of coal under 10 to 12 square feet of heating surface.

1 B.T.U. = 778 foot-pounds.

1 pound of bituminous coal contains about 14,100 B.T.U. or 11,000,000 foot-pounds of energy.

INDEX

- A
- "A" frame dams described, 384
Abandoned irrigated lands, 185
Acoustic current meter, 156
Acre-foot, definition of, 165
— table of equivalents, 616
Acre-inch, definition of, 165
Advantages of irrigation, 5
Agricultural Department experiments
 on duty of water, 143-145
Agua Fria, underground waters, 47
Air in running water, 293
Air-lift pumping, 92
Alcohol pumping engines, 85, 86
Aldershot, sewage irrigation at, 126
Alexander, W. H., book by, 63
Alfalfa as a nurse crop, 105, 106
— as preventive of alkali, 13
Algeria, area irrigated in, 4
Alinement of canals, 212-215
Alkali, concrete lining protection, 238
— in canals, prevention of, 521
— or injurious salts, 8-15
— rise of, brief discussion, 190, 191
— resistance to, table, 11, 12
— tests of cement pipe, 199, 200
Alkaline salts, discussion of, 8-15
— soils, effect on metal, 308-314
Allegheny River, flow and area, 592
Allier River, France, flood, 595
All Saints Church, pressure on foundation, 447
Alluvial soils, definition of, 7
Alvord, J. W., book on floods, 63
Ambursen type dam, mention, 487. See
 Hollow Dams.
American River, flood and area, 593
— — flow of, 42
— — Folsom dam, 385
American Society of Agricultural Engineers, data, 148
Analysis of soils, table, 9
— Shoshone Dam, illustrated, 474
Ancient irrigation works, mention, 2
Androscoggin River, flood and area, 592
Anticlinal valley as reservoir site, 345
Application of water to land, 111-136
Appropriation, water, doctrine of, 496-500
Appurtenance to land, water rights, 500, 501
Aquatic plants, growth of, 521-524
Aqueduct, Ganges Canal, India, 301
— Nadrai, India, 313
— Strawberry Valley, illustrated, 336
Arabs, irrigation by, in Sahara, 62
Arch Bridge pressures, 447
— dam, definition of, 443
— dams, design of, 469-474
— spillway, East Park, 485
Ardèche River flood, France, 355, 595, 596
Areas irrigated in countries, table, 4
— reservoirs, table, 598
— river drainage basins, 592-596
Argentina, area irrigated, 4
Arizona Canal, data about, 230
Arkansas River, flow of, 42
Arrowhead Dam, height and length, 599
— Reservoir, evaporation, 71
Arrowrock coffer dam, illustrated, 402
— Dam, and gunnite, 452
— — balanced valve, 365
— — data, 600
— — plans and section, 458-460
— — pressure, 447
— — specifications, 535-546
— Reservoir, area, cost, etc., 598

- Arroyo Seco, flood and area, 594
 Artesian areas, 50, 51
 — wells, 48-59
 — — books on, 63, 64
 Ash Fork Dam, Arizona, 487-490
 — — — data, 600
 Ashti Dam, India, data, 599
 Asse River, France, flood, 595
 Assiout Dam, Egypt, data, 600
 Assuan Dam, data, 600
 — — silt removal at, 376, 377
 — — steel canal below, 241, 242
 Assyria, records of irrigation in, 2
 Auckland Dam, data, 600
 Aupa River, Germany, flood, 596
 Ausable River, flood and area, 593
 Australia, area irrigated in, 4
 — Goulburn Weir, 397
 — Rainfall records, 356
 — regulator gates in, 254
 Australian salt-bush and alkali, 13
 — water meter, 177
 Austrian Soc. E. and Arch., pressure
 data, 447
 Automatic recording gage, 160, 161
 — shutters and gates, 392
 — spillways, 275-277
 — — Tieton, 280-282
 Avalon Dam failure explained, 422
 — Reservoir, area and capacity, 598
 Azischos Dam, data, 600
 Azusa hydrant meter, 173
- B
- Babylonia, records of irrigation in, 2
 Backfilling over drain tiles, 197
 — specification clause, 559
 Bacteria, sewage irrigation and, 128
 Badana Dam, data, 600
 Baker, I. O., pressure data, 447
 Baker, M. N., book on sewage, 64
 "Baffle piers" at dams, 477, 478
 Balanced valves, 360, 365
 — — illustrated, 364-369
 Balmorhea Dam, data, 599
 Ban Dam, France, data, 600
 Barage du Nil, mention of, 387
 Bargaglino Cr., Italy, flood, 596
 Bark, Don H., address by, 26
 — article by, 15
 — book by, 152
 — bulletin by, 183
 — seepage data, 234
 Barker Dam, data, 600
 Barossa Dam, data, 600
 — — pressure, 447
 Barrin Juick Dam, data, 600
 Basic Creek, flood and area, 594
 Bassano Dam, design mention, 477, 478
 Baum Co., F. G., constant angle dam,
 472
 Bazin formula, pipe, 326
 Beacon Brook, N. Y., flood, 595
 Bear River, flood and area, 594
 — — flow of, 44
 — — canal drop, 285
 — — crib dam, illustrated, 401
 Bear Grass Creek, flood and area, 594
 Bear Valley Dam, plan and section, 473
 — — — pressure on, 447
 Bear Valley Dams, Big and Little, 600,
 601
 Beaumont rice pumping plant, 98
 Beavers, first dam makers, 382
 Beetaloo Dam, data, 600
 "Before and After" irrigation views,
 100-101
 Belle Fourche Dam, paving, illustrated,
 418
 — — — material used, 423
 — — — gravel blanket on, 436
 — — — outlet works of, 358
 — — — section of, 406
 — — Reservoir data, 598
 — — tunnel data, 334
 Bench marks, specification. clause, 553
 Beneficial uses of water, law of, 497, 499
 Berlin, deep well near, 51
 Betwa Dam, India, data, 600
 — weir flashboards, illustrated, 393
 Bezvara Weir, India, section, 391
 Bhatgur Dam, India, data, 600
 Big Bear Valley Dam, data, 600
 Bigelow, F. H., paper on evaporation, 71
 Billings, Mont., analysis soils, 9

- Bjorling's formulas for water wheels, 80, 82
- "Black Alkali," definition of, 8
- Black Lick River, flood and area, 594
- Bleone River, France, flood, 595
- Bligh, W. G., book by, 495
— — pressure data, 447
- Blue Nile, irrigation waters of, 25
- Boat gaging station, illustrated, 162
- Bober Dam, Germany, data, 600
— River, Silesia, flood, 595
- Boise canal dam and gates, illustrated, 255
— chute and stilling basin, 291
— pipe manufacture, illustrated, 323, 329
— project, cost of canal lining on, 243.
 See also Arrowrock Dam.
— River, flow of, 43
— — hydrograph of, 34
— Valley, analysis soils, 9
— — ground water charts, 186-189
— — steel flume in, 307
- Bond, specification clause, 548
- Boonton Dam, N. J., data, 600
- Border methods of irrigation, 112-117, 124
- Borings, dam foundations, 493, 494
- Borrow pits, specification clause, 558
- Bowman Dam, data and section, 437, 599
- Bow River, flow of, 44
- Box turnout, U. S. R. S., plans, 267
- Boys Corner Dam, data, 600
- Brasimone Dam, data, 600
- Brazil rainfall records, 356
- Breaks in canals discussed, 271
- Breast-wheels, description of, 81
- Bridge Pont-y-Prydd, pressure on, 447
- Bridgeport Dam, data, 600
- Bridges over canals, 335-337
— steel, specifications, 579-584
- Briggs, L. J., book by, 25
— — investigations of, 20, 21
- Broad River, flood and area, 593
- Brodie data on masonry pressure, 447
- Brooklyn Bridge, pressure on, 447
- Brown, Hanbury, books by, 152, 527
- Buck scraper, description of, 229
- Buckley, R. B., book on irrigation by, 71
- Budlong Creek, N. Y., flood and area, 595
- Buech River, France, flood and area, 595
- Bumping Lake Dam data, 598
— — — section, 433
- Burdick, C. B., book on floods, 63
- Bureau of Soils, analyses by, 9 :
- Bureau of Standards alkali tests, 199, 200
- Burkholder, J. L., article by, 201
— — Chart of Rio Grande, 187, 188
- Burns Creek, superpassage, illustrated, 316
- Burrin Juick Dam, pressure, 447
- "Burro" Dam described, 382
- Burrowing animals, 525, 526
- Butterfly valves, illustrated, 362, 366, 367
- By-pass, Umatilla Canal, 288
- C
- Cabbage Tree Dam, data, 600
- Cable station, stream gaging, 161
- Cache La Poudre, flow of, 42
— — — seepage to, 245
- Cain, Wm., book by, 495
- Cairo, Barage du Nil near, 387
- Calaveras Dam, data, 599
— — failure of, 429, 430
— River, flood and area, 594
- Calcium carbonate and alkali, 14
- California, irrigation in, book on, 63
— rainfall records, 356
— State Board of Health, 5
— stovepipe well drilling, 57
- Calloway Canal, Cal., silt in, 25
— — weir at, 388-390
- Camp, specification clause, 537
- Canada, area irrigated in, 4
- Canada Creek, W., N. Y. flood, 594
- Canal cross sections, illustrated, 204
— lining, 236-245
— losses and prevention, 233, 234
— riders, duties of, 503
— specifications, 557-559
— structures, chapter on, 247-369

- Canal superintendent, duties of, 502.
503
— zone, rainfall records, 357
Canals, list of U. S. R. S., 230-232
— and laterals, chapter on, 202-246
Cane Creek, flood and area, 594
Canvas Dam used in irrigation, 112, 113
Canyon Creek Dam, Utah, data, 599
Capillarity of soils, table of, 18
Capillary movement in soil, 16, 17, 18
Carbon dioxide in tunnel, 335
Carbonate of sodium, 8, 11
Carey Act, mention of, 3
Carlsbad canals, lining and costs, 242
Carpenter, L. G., book on duty of water,
152
— — bulletins by, 182, 246
— — experiments, return seepage by,
245
Carson River, East, flow of, 43
— — regulator, 251-257
Carver's data on hydraulic rams, 92
Casey, Col. T. L., masonry pressure, 447
Casselman River, flood and area, 593
Cast-iron specifications, 563
— — gates, lateral illustrated, 269
Castlewood Dam, section, 438
Cataract Dam, data, 600
Catawba River, flood and area, 592, 593
Catskill Creek, flood and area, 594
Cattaraugus Creek, flood and area, 593
Cavour Canal, Italy, views, 298
Cedar River, flood and area, 594
— — flow of, 44
Cement drains, use of, 198-200
— gun work, Arrowrock Dam, 452
— lining canals, coefficient, 235
Cement, specification clause, 536, 537.
559, 565, 566
Centrifugal pumps, 86-90
Certified check, specification clause, 547
Chagres River, flood and area, 593
Chamberlain, T. C. report on wells, 63
Chandler, A. E., book by, 501
Changes, specification clause, 550, 551
Chapter House, Elgin, pressure on, 447
Charges for water, basis, 514, 515
— — — U. S. R. S. table, 146
Chartrain Dam, data, 600
Chattahoochee River, flood and area,
592, 593
Chaustiere Dam, data, 600
Cheat River, flood and area, 593
Check and farm turnout, illustrated, 264
Check system of irrigation, Salt River,
illustrated, 122
Checks, drops and chutes, 282-290
— used in irrigation, illustrated, 116
Chemical properties, metal, 578
Chemung River, flood and area, 592
Cherry Creek, Colo., water supply, 59
Cherryvale Creek, Kansas, flood, 595
Chezy formula, 163
China, mention of irrigation in, 2, 4
— rainfall at Hongkong, 356
Chinamen, market gardening of, 58
Church, Irving P., book on fluids, 182
Chute or inclined drop, 212
Chutes, checks and drops, 282-290
Chuiscar Dam, Mexico, data, 600
"Cienegas," term for swamps, 194
Cippoletti weir, book on, 182
— — definition of, 166, 167
— — formula for, 167
Clarion River, flood and area, 593
Clarke, Sir Andrew, masonry data, 447
Classification, masonry dams, 443
Clay in hydraulic fill dams, 428
Clay, used in earth dams, 423
Cleaning canals of silt, 520, 521
Cleaning up, specification clause, 553
Clear Lake Reservoir, data, 598
Clearing of irrigable lands, 104
Clentangy River, flood and area, 593
Climatic conditions, specifications, 552
Climatology of U. S., book on, 63
Closed drains, definition of, 191
Coast Range and rainfall, 28
Coefficient of roughness, 602, 603
Coefficients of friction, table, 448
Coffer dam, Arrowrock Dam, 402
— — specification clause, 544
Coghlan, silt data, 371
Cohoes Iron Weir, section, 486, 489
Cold Spring Dam, building, illustrated,
427

- Cold Springs Dam, flood at, 355
 — Reservoir data, 598
 Colorado River, bulletin on, 63
 — flow of, 42
 — headgates, 251, 253, 256
 — value of silt of, 25
 Columbia River flow of, 43
 — maximum flow of, 592
 Compressed air used in pumping, 92
 Compression, on masonry, 447
 Concentrated crest spillway, illustrated, 274
 Conconully Dam, flumes used, illustrated, 431
 — outlet works, 359, 360
 — section of, 435
 — Reservoir, water records, 40
 — tunnel data, 334
 Concrete, canal lining, 237-245
 — gravel, pressure on, 447
 — pipe specifications, 574-576
 — specifications, 540-543, 559-561
 — turnout, lateral, illustrated, 270
 Cone, V. M., bulletin by, 183
 — flume invented by, 179
 "Constant angle" dams, 472, 473
 — Dam, book on, 495
 Construction, earth dams, 424-426
 Continuous stave pipe, 324
 Contract specifications, text of, 547-554
 Contracted orifice, definition of, 169
 Contraction joints, concrete lining, 237
 — in dams, 453
 Contractor, specification clause, 548
 Contractor's bond, specification clause, 548
 Coolgardie Dam, data, 600
 Cooperation with water users, 504
 Coosawattee River, flood and area, 593
 Corbett Dam, cross section, 248, 249
 — Tunnel, data, 334
 Core wall, concrete, Kachess Dam, 414
 — concrete, Minidoka Dam, 436
 — earth, Bumping Lake, 433
 — gravel in dam, 423
 — puddle, Conconully Dam, 435
 — steel, Otay Dam, 438
 Core walls, earth dams, discussed, 422
 Corrugation system of irrigation, 119, 120
 Cost, clearing lands, 104-106
 — drainage ditches, article on, 201
 — drains, U. S. R. S., 200, 201
 — earth dams, table, 599
 — estimates of, projects, 531-533
 — leveling land, 110
 — lined canals, U. S. R. S., 242, 243
 — masonry dams, table, 600, 601
 — puddling, canal lining, 243
 — pumped irrigation water, 511
 — Reservoirs of U. S. R. S., 598
 — silting porous canals, 244, 245
 — tunnels, built by U. S. R. S., 334
 — water, Reclamation Service projects, 146
 — well drilling, 57
 Cosumnes River, flood and area, 593
 Cottonwood Creek, flood and area, 594
 Coulon River, France, flood and area, 595
 Court decision, Salt River, 149
 Covell Creek Dam, Australia, data, 601
 Cowgill's diagram of flood irrigation, 117
 Creager, W. P., book by, 495
 Creager's compressive tests, 446
 Crib dams, illustrated, 401, 402
 Crib work, underground, 59, 60
 Cronholm, F. N., article by, 201
 Crops and duty of water, 139-142
 Crossings, drainage, 293-299
 —, highway, 335-337
 Cross River Dam, data, 600
 Cross-section and subgrade, 210-212
 Croton Dam, cross-section, 464
 —, N. Y., data, 601
 —, Old, section, 479
 Croton Falls Dam, data, 600
 Croton watershed, paper on, 380
 Crowley Creek Dam, data, 600
 Cuba, rainfall records, 357
 Cubic foot per second, definition, 165
 Cultivation and duty of water, 140, 141
 Cultivation under irrigation, 515, 516
 Culverts, irrigation canals, 314-323
 Current meter measurements, 171, 172
 Current meters, description of, 155-163

Current wheel on Salmon River, 89
 "Cusec" definition of, 165
 Cuyamaca Dam, data, 599
 Cylinder drop, Franklin Canal, 289

D

D'Arcy pipe formula, 326
 Dalles, flow Columbia at, 592
 Dabrowka Creek, Austria, flood, 596
 Damages, specification clause, 552
 Dams, canvas and steel, for irrigation,
 113
 — chapters on, 381-495
 — list of books on, 495
 — submerged, 61
 — tables, height, cost, etc., 599-601
 — underground water, 61
 Darton, N. H., report on deep borings,
 63
 — —, underground water, 47
 Davis, A. P., books by, 98, 201, 380
 Dean and Follansbee, bulletin by, 63
 Deer Flat Embankment, cross section,
 416
 Deer Flat Embankment, gravel face,
 illustrated, 418
 Deerfield River flood and area, 593
 Deerflat Reservoir, area, cost, etc., 598
 — — leakage, 347-349
 Defective work, specifications, 553
 Dehree Weir, India, illustrated, 391
 Del Rio, Texas, pumping plant, 95-97
 Delaware River, flow and area, 592
 Delays, specification clauses, 549, 550
 Derwent Dam, Eng., data, 600
 Deschutes River, book on, 63
 — — flow of, 43
 — — outlet, Tumalo, 347
 Desert Land Act, mention of, 3, 497
 Design, Masonry Dams, 455, 475
 Dethridge meter for measuring water,
 175-176
 Devil's Creek, flood and area, 594
 Devil's River, flow of, 44
 DeVries, analysis of soils by, 9, 10
 Dew Point, definition of, 27
 Diamond drilling dam foundations, 494
 Direct explosion pumps, 95-97

Discharge measurements of streams,
 154-157

Discharge records of streams, 42-44
 Ditch riders, duties of, 503
 Ditcher, "V" illustration of, 107
 Ditching, irrigable lands, 110
 Ditching machine, view of, 228
 Diversion dams or weirs, 382-404
 — —, overfall, 475-490
 Dixville Dam, data, 599
 Domodossola Dam, Italy, data, 599
 Drag line excavator, view of, 192
 Drainage area, effect of, 40
 — — of rivers, 592-596
 Drainage; books on, list, 201
 —, chapter on, 184-201
 — crossings, 293-299
 —, irrigation and health, 5, 6
 — systems, design of, 193-198
 Drains, classification of, 191-193
 Drake, E. F., report by, 183
 Drilling dam foundations, 493-495
 Drilling wells, methods, 53-57
 Drop and turnout, canal, 268
 —, canal, pump at, 90
 Drops, checks and chutes, 282-290
 "Dry lakes," formation of, 345
 DuBois, A. Jay, book translated by, 183
 Durance River, France, flood, 595
 — Valley, value silt in, 25
 Duryea, Edwin, paper on evaporation,
 71
 Duty of sewage water for irrigation, 130
 — — water, books on, list, 15, 152
 — — —, chapter on, 137-152
 Dyer, C. W. D., paper on weirs, 182

E

Eads Bridge, pressure on piers, 447
 Earth, evaporation from, 69, 70
 Earthen dams, discussion of, 405
 Earthquakes, rock-fill dams and, 441
 Earthwork, specification clauses, 556-
 559
 East Carson River, flow of, 43
 East Park Dam, data, 600
 — — — spillway, 482, 485, 486
 — — Diversion Dam, view, 482

- East Park Reservoir, area, cost, etc., 598
- Economy of water, 504-511
- Eder River, Germany, flood, 595
- Edinburg, sewage irrigation at, 126
- Egin Bench subirrigation, 133
- Egypt, abandoned irrigation lands in, 185
- area irrigated in, 4
- book on irrigation in, 71
- records of irrigation in, 2
- reference to irrigation works, v
- steel lined canals in, 241, 242
- Einsidedel Dam, data, 600
- Electric power, specification clause, 537
- Elephant Butte Dam, data, 600
- — —, cross section, 454
- — — construction, 455, 462
- — — design against uplift, 453
- — — pressure, 447
- — Reservoir, table data, 598
- — — silt in discussed, 377-380
- Elkhorn Cr., flood and area, 594
- Elliott, C. G., Bulletin by, 201
- Elevating grader, view of, 228
- Embankments, rules for, 405. See also Deer Flat.
- Engineer, specification clause, 543
- Engines for pumping, 84-86
- Ensign, balanced valve, 360, 365
- Eolian soils, definition of, 7
- type of land, 219
- Erosion and canal design, 214
- prevention of, in canals, 519, 520
- protection against, 290-295
- Escondido Dam, data, 599
- Esopus Cr., flood and area, 594
- Estacado Dam, paper on grouting, 495
- — pressure on, 447
- Estanzuela River, Mexico, flood, 595
- Estimates and reports, specifications, 536
- of cost of project, 531-533
- Etcheverry, B. A. books by, 15, 26, 98, 136, 246
- —, lined canal experiments by, 242
- , silt data by, 373
- Eucalyptus globulus, effect of, 6
- Evaporating pan, illustration of, 67
- Evaporation and rainfall, 41
- , books on, list of, 71
- , chapter on, 65-72
- table, cities of U. S., 69
- , table on, by months, 72
- Evaporometer, observations, 68
- Excavating machinery, views of, 192
- Excavation, specification clauses, 538-540
- Expansion joints, concrete lining, 237
- — in dams, 453, 457-461
- Experience, specification clause, 551
- Explosion, pumps, direct, 95-97
- Extra work, specification clause, 550
- Eyach River, Germany, flood, 596

F

- Failure, masonry dams discussed, 444, 447, 449
- Famine in India, 185
- Fanning, J. T., book by, 182
- —, pressure data, 447
- discharge formula, 596
- Farm laterals, construction of, 110
- Farm turnout and check, illustration, 264
- Fay Lake outlet works, illustration, 360, 361
- Feather River, flood and area, 592
- —, flow of, 42
- "Federal vs. Private irrigation," 6
- Fernow, B. E., evaporation data by, 70
- Fertility and soil surveys, 101-103
- Fertilizing effect of sediments, 25
- Fertilizing effects of sewage, 128, 129
- Filtration, intermittent method, 126, 127
- Financial obligations, specification clause, 551
- Fippin and Lyon, book by, 26
- , analysis of soils by, 9
- Fish Cr. N. Y., flood and area, 594
- Fish screens, Umatilla project, 483
- Fishkill Cr., flood and area, 594
- Fitzgerald, Desmond, evaporation experiments, 66
- Flashboard, automatic, dams, 392, 393

- Flashboard weirs, 388-390
 —, Laguna gates, illustrated, 253
 — use of, 257
 Flathead project, sink holes, 224-226
 Fleming, W. B. book on pumps, 98
 Flinn, A. D., paper on weirs, 182
 — — book by, 380
 Flint River, flood and area, 593
 Float, for leveling, illustrated, 110
 Floats, stream measurement, 155
 Flood discharges, table of, 592-596
 — flows of rivers, examples, 355-358
 — prevention, reference to, 380
 Floods and spillways, 354-358
 —, books on, 63, 64
 Flooding method of irrigation, 111, 112
 Florida, subirrigation in, 135, 136
 Flow of water, books on, 182, 183
 — — —, tables, 604-610
 Fluctuations of ground water, 186-189
 Flume, Bear River Canal, 295
 — concrete, standard plans, 296
 — steel, Uncompahgre Valley, illustrated, 322
 — tables, hydraulic data, 613
 Flumes, chapter on, 299-308
 — metal, specifications, 576-579
 Flynn, P. J., book on irrigation canals, 182
 Follensbee and Dean, bulletin by, 63
 Follett, W. W., article by, 380
 — book on silt by, 26
 — Rio Grande silt, 379-380
 — silt data of, 371
 Folsom canal gates, illustrated, 262
 — — and weir, illustrated, 383, 385
 — Dam, data, 600
 Food for plants, chapter on, 22-26
 Foote measuring weir, 173-175
 Forbes, R. H., bulletin by, 26
 Foreign countries, area irrigated, 4
 Forms, concrete, specifications, 561
 — pipe, Boise project, illustrated, 329
 Formula, arch dams, 469
 — canal design, 202
 — erosion and canal design, 214
 — flood discharge, 596, 597
 — flow in pipe, 326, 330
 Formula, flow in turnout, 268, 269-271
 — Kutter's, 602, 603
 — lateral capacity, 221
 — loss of head siphon, 318
 — orifices, 170
 — seepage losses, 235
 — siphon spillway, 275
 — stream measurement, 163-170
 — thickness of dam, 456
 — velocity head, 614
 — weirs, 167, 168
 Fort Shaw canal spillway, illustrated, 277
 Fortier, Sam'l, books by, 6, 26, 136-152
 — bulletins by, 71, 246
 — on duty of water, 148
 — percolation of water by, 48
 Foundation, earth dams, 405-409
 Foundations, masonry dams, 490-493
 — — pressures on, 447
 Fox Cr. Crossing, L. Yellowstone, illustrated, 320
 France, area irrigated in, 4
 —, examples of silt in, 25
 —, flood flows in, 355
 Francis formula for weirs, 167
 Franklin Canal, cylinder drop, 289
 Free board of canal banks, 210
 French open weirs, illustrated, 394, 396
 Fresno scraper, view of, 109
 Friction, coefficients, table of, 448
 Friez recording stream gage, 160
 Frozen streams, measurements of, 162, 163
 Furens Dam, France, data, 600
 — River, France, flood, 596
 Furrow Irrigation, bulletin on, 15
 — — in Idaho, illustrated, 125
 — — methods, 117-119
 — system irrigation, Cal., illustrated 122
- G
- Gaging streams, 153-157
 Galvanized sheets, advantages of, 309
 Ganges Canal aqueduct, 301
 — — super passage, 311
 — — weirs, sections, 391

- Ganguillet and Kutter formula, 164
 Garden City windmill and reservoir, 88
 Garland Canal, dimensions, 232
 — — turnout, 268
 Gas engines for pumping, 84, 85
 Gas tar, waterproofing dam with, 453
 Gasoline pumping engines, 85, 86
 Gate, cast iron, lateral illustrated, 269
 Gate House, Conconully Dam, 360
 Gates, canal wood and metal, 250-254
 —, reservoir, illustrated, 361-369
 Gatun Dam, design mentioned, 407-477
 — — data on, 411, 412
 — — volume of, 599
 Gem Lake Dam, data, 600
 Geologic structure and rainfall, 41
 Geological Survey current meters, 156
 — — stream flow records, 39
 Geology, reservoir sites, 344-346
 German patent roller dams, 394
 Gila River, report of, 380
 — stream flow records, 42
 Gillepe Dam, Belgium, data, 600
 Glacial soils, definition of, 7
 Glatzer Neisse River, Germany, flood, 595
 Godivery Weir, India, section, 391
 Goldbach River, Germany, flood, 596
 Goodwin Dam, Cal., data, 600
 Goodyear Cr., flood and area, 595
 Gorzente Dam, data, 600
 Goss, Arthur, soil book by, 26
 Goulburn Canal gates, Australia, 254
 — Weir, Australia, illustrated, 397
 Grade of lands for irrigation, 100
 Grader, elevating, view of, 228
 Grand River, flow of, 42
 — — Dam, illustrated, 396-400
 Grand Valley canals lining, 243, 244
 — — lands subsidence, 225
 — — tunnels, data, 334
 Grande Ronde River, flow of, 44
 Granite ashlar, pressure on, 447
 Granite Reef Dam, plan and section, 476
 — — — in flood, 481
 Granite Springs Dam, data, 600
 Grant-Mitchell meter, 177
 Gravel core, view Sherburne Dam, 434
 Gravel protection, Deer Flat Reservoir, 415-417
 Greasewood, presence of, 102, 104
 Great Forks, analysis soils at, 9
 Great Salt Lake, origin irrigation, 2
 Greaves, Chas., evaporation experiments, 66
 Green, J. S., report by, 182
 Green River, flow of, 44
 — — hydrography, 35
 — — water wheels on, 80
 Gregory, W. B., book on pumps, 98
 — pump data, 87
 Grinnell well in Paris, 50
 Ground water fluctuation, 186-189
 — — required depth to, 195
 — — supply for pumping, 74
 Grouting dam foundations, 492, 493
 — foundations, specifications, 542, 543
 Grover, N. C. & J. C. Hoyt, book by Messrs., 63, 182
 Gunnison tunnel, data, 334, 335
 "Gunnite" on face Arrowrock Dam, 452
 Gurley recording stream gage, 160
 Gypsum and alkali, 14, 15
 — formation, reservoirs in, 345, 349, 350
 — leakage of canals in, 227
- ### H
- Habra Dam, Algiers, data, 600
 Haehl, H. L., evaporation report, 71
 Hale's Bar Dam, data, 600
 Hall, W. H., book on irrigation in California, 63
 Hamlin, Homer, book on Salinas Valley, 64
 — — underflow tests, 63
 Hamlin's chart of California rainfall, 33
 Hanna, F. W., article by, 246
 — — hand book by, 183
 — recording meter, 173
 Happy canyon steel flume, illustrated, 322
 Harding, S. T. O. and M., book by, 527
 Harrison, C. L., paper by, 495
 Hart, R. A., bulletin by, 201
 Haskell current meter, 155, 156
 Hatfield Dam, data, 600

- Hauser Dam, New, Mon., data, 601
 Hawaii, area irrigated in, 4
 Hawaiian Islands, article on, 98
 — — pumping plant, 86
 Hay, Prof. Robt., well reports, 63
 Hazen, Allen, formula, 46, 47
 Head, loss of, formula, 318
 Head gates, canal, 248-262
 Headworks, canal, 247-262
 Health and irrigation discussed, 5, 6
 — — sewage irrigation, 129, 130
 Height of Dams, table of, 599-601
 Hellreigel's data on plant water, 23
 Hemet Dam, valve plug, illustrated, 362
 Hemlock Dam, data, 600
 Henne Dam, Germany, data, 600
 Henny, D. C., article by, 6
 — — flume invented by, 178
 Henry, A. J., book by, 63
 — — precipitation charts by, 36, 37
 Henshaw, Lewis, bulletin by, 63
 Herndon, Cal., stream flow at, 33
 Highway crossings, 335-337
 Hilgard, E. W., book by, 15
 — — bulletin by, 26
 — — soil experiments by, 14, 15, 21
 Hill, Louis C., meter invented by, 176
 Hill, Prof. Robt. T., book by, 63
 — meter for measuring water, 176
 Himalaya Mts., rainfall in, 357
 Hindia Barrage, data, 600
 History of irrigation, 2-4
 Hiwassee River, flood and area, 593
 Hollister, G. B., bulletin by, 183
 Hollow concrete dams, 478-487
 Holyoke Dam, section of, 475
 Hondo Reservoir, leakage, 350
 Hoosic River, flood and area, 593
 Horse-power equivalents, 616, 617
 Horseshoe Bend Dam, data, 599
 — section, hydraulic tables, 612
 Horton, R. E., weir tables, 182
 Hot air pumping engines, 85, 86
 Hotzenplotz River, Germany, flood, 595
 Howden Dam, England, data, 600
 Hoyt, J. C., article by, on rainfall, 63
 — — and Grover, N. C., book by, 63, 182
 Hoyt, J. C., bulletin by, 183
 Huacal Dam, Mexico, data, 600
 Hudson River, flow and area, 592, 93
 Hughes, D. E., report by, 380
 — — silt data, 371, 373
 "Human side of irrigation," 6
 Humboldt River, flow of, 43
 Hume-Bennett Dam, data, 600
 Humphrey, direct-explosion pump, 95-97
 Humphrey, H. A., article by, 98
 Humus, lack of, 8
 Huntley, duty of water at, 147
 — pumping plant, 90
 Hydrant, Azusa, meter, 173
 Hydraulic data tables, 611-617
 — books on, 64, 182, 183
 — equivalents, table, 616, 617
 — fill dams, 426-436
 — formulæ, 163-170
 — jump, Granite-reef Dam, 481
 — radius in canals, 205
 — radius tables, 604-613
 — ram, data, 91, 92
 — rams, Yakima Valley, 88, 92
 Hydro-electric pumping, 92, 95
 Hydrographers, duties of, 503, 504
 Hydrographic manual, 183
 Hydrographs of rivers, 33-35
 Hydrology, books on, 63, 495
 Hydrometric surveys, reports on, 183
 Hydrostatic uplift on dams, 451-453
 Hygroscopic water, in soils, 16, 17
- I
- Ice, measuring streams through, 163
 — pressure in dam design, paper on, 495
 — pressures on dams, 450, 451
 — snow and, evaporation of, 68
 Imperial Valley silt conditions, 222
 India, area irrigated in, 4
 — book on irrigation in, 6, 71
 — famine and malaria in, 185
 — notch drop in, 284
 — rainfall records of, 356
 — reference to irrigation works of, v
 — unit of flow, "cusec," 165

- India, wells, irrigation from, 58. See Ganges Canal.
- Indian Government's investigations, 5
— type weirs, illustrated, 390, 391
— River Dam, N. Y., data, 600
- Ingot iron, effect of alkali on, 309
- Injurious salts or alkali, 8-15
- Inspection gallery specifications, 54-56
—, specification clause, 551
- Integration method of stream measurement, 158
- "Intermittent filtration" methods, 126, 127
- Internal combustion engines, 84, 85
- Interstate Canal flume, 303, 308, 310
— — gates, illustrated, 251
— — headworks, 259
— — lateral gates, 269
— — lining, view, 239
— — sections, 204
— — siphons, illustrated, 317, 318
- Investigation of a project, 528-533
- Iola, Kans., stream flow at, 34
- Irawaddy River, India, flood, 596
- Iron pipes, subirrigation by, 136
- Iron weir, Cohoes, section, 486, 489
- Irrigable lands, chapter on, 99-110
- Irrigation, books on. See end each chapter.
— definition of, 1
— "Institutions," book, 501
— methods of, 111-136
— rotation methods, 512-514
— rules, Utah, 150-152
- Italians, market gardening by, 58
- Italy, area irrigated in, 4
- J
- Jackson, L. D'A., book by, 64
- Jackson Lake Dam, view of, 260
— — Reservoir, area, cost, etc., 598
- Jaffa, M. E., soil experiments of, 13
- Jamaica rainfall records, 356
- James, George Wharton, book by, 6
- James River Valley Wells, 51
- Japan, area irrigated in, 4
— rainfall records, 356
- Java, area irrigated in, 4
- Jerome Reservoir, leakage, 351
- John Day River, flow of, 44
- Johnson grass and sheep, 525
- Johnston, C. T., book by, 501
- Jorgenson, L. R., book by, 495
— on arch dams, 469
- Jorgenson's arch design, 484
- Jump, hydraulic, Granite-reef Dam, 481
- Juniper, clearing lands of, 105
- K
- Kachess Dam, cross section and data, 414, 420
— Reservoir, data, 598
- Keechelus Dam outlet, illustrated, 366
— Reservoir data, 598
- Kennebec River, flood and area, 592
- Keno Canal spillway, illustrated, 274
- Kensico Dam, N. Y., data, 600
— — — pressure, 447
- Keokuk Dam, Iowa, data, 600
- Kern River, flow of, 42
— — diversion weir, illustrated, 388, 389
- Khojok Pass, tunnel for water, 59
- Khrishna River, India, flood, 596
- Kinder River Dam, data, 599
- King, F. H., book by, 15, 201
- King's data on plant water, 23
— River, flood and area, 593
— —, flow of, 42
- Kingman, Ariz., dam at, 403, 404
- Kiskiminetas River, flood and area, 593
- Klamath project, Lost River Dam, 252
— project spillway, illustrated, 274
— tunnel data, 334
- Kneale and Tannatt, bulletin, 201
- Kuichling, Emil, paper by, 63
— formula discharge, 596
— Prof., flood records, 358
- Kutter's formula, 164
— — for pipe, 326
— — tables, 602-610
- L
- La Boquilla Dam, Mexico, data, 601
- La Grange Dam, Cal., data, 601
— — section, 480

- La Jalpa Dam, Mexico, data, 601**
La Mesa Dam, data, 599
Labrador, evaporation in, 65
Lagastrello Dam, Italy, data, 599
Laguna Dam headgates, illustrated, 251,
 253, 256
 — — plan and section, 386, 387
Lahontan Dam outlet, illustrated, 363
 — — plan of, 408
 — Reservoir, data table, 598
Lake Bonneville, settlement of canal at,
 227
Lake Cheesman Dam, data, 601
Lake Conchos, evaporation on, 71
Lake Fife Dam, India, data, 601
Lake McMillan, leakage, 349, 350
Lakes as reservoir sites, 342, 343
Lands, irrigable, chapter on, 99-110
Landslides on canals, 526, 527
 — values, effect on irrigation, 3
Laramie River, flow of, 44
 — — Dam, data, 599
 — Reservoir, flood and area, 594
Larue, E. C., bulletin by, 63
Las Vegas Dam, data, 599
Lateral canal systems, 217-224
Laterals, canals and, chapter on, 202-246
 —, farm, construction of, 110
Lauchensee Dam, data, 601
Lava, reservoir site in, 345, 351
Law of water, chapter on, 496-501
Lawes and Gilbert's data on water, 23
Lawson, silt data, 371
Leaching of soils, 12-13
Leakage, canal, discussed, 224-227
 — reservoir, discussed, 346-354
Leasburg Canal gates, illustrated, 250
 — —, sand box, illustrated, 339
 — diversion weir, section, 478
Leffel turbine, water-wheel, 83
Leipsic, deep well near, 51
Length of season and duty of water, 138
Leveling irrigable lands, 107-110
 — of land, necessity for, 103
Lewis, John H., book by, 501
Lick Observatory Records of rainfall,
 356
Lined canal, Okanogan, illustrated, 321
Lined canal section, 211, 213
Lining canals, 236-241
 — steel, canal, Egypt, 241, 242
Lippincott, J. B., book by, 380
Lister Dam, Germany, data, 601
Lithgow Dam, pressure, 447
Little Bear Valley. See Bear Valley,
 601
Little Tennessee River, flood and area,
 593
Local conditions, specification clause,
 551
Lock-bar pipe described, 326
Log hoist, specification clause, 546
Loire River, flood of, 355
Los Angeles, sewage irrigation, 130
Losses, canal and prevention, 233, 234
 — early irrigation, 3
 — seepage, 234-236
Lost River and Tule Lake, 352
 — — diversion works, illustrated, 252
Loughridge, R. H., book by, 15, 26
 — investigations of, 11, 12, 20
Louisiana, rice irrigation in, 86, 97, 98
Low-head pumping plants, 86
Lower Otay Dam. See Otay.
Lower Yellowstone Canal drop, 287
 — — — sluiceway, 278
 — — culverts, illustrated, 315, 316
 — — Dam, section, 387
 — — pipe inlet, 294
 — — sand gate, 340
 — — siphon, illustrated, 320
Lyon, analysis of soils by, 8
Lyon and Fippin, book by, 15, 26
 — — experiments on soil, 18

M

- McAdie, A. G., book on rainfall, 64**
McAlester Dam, data, 599
McCall's Ferry Dam, section, 480
McCausland, bulletin by, 63
McCloud River, flood and area, 593
McDowell, Ariz., stream flow at, 35
MacMillan Dam, data, 599
 — Lake, data, 598
 — Reservoir, leakage, 349, 350
Mahan, F. A., book on water wheels, 98

- Maintenance, operation and, chapter,**
 502-527
 — work, when to do, 518, 519
Malaria, effects of irrigation, 5, 6
 — in India, 185
Malheur River, flow of, 43
Malleable castings, specifications, 564
Manholes, drain lines, 197, 198
Manning, Robt., book by, 64
Marklissa Dam, Germany, data, 601
Masonry Dams, chapter on, 442-495
 — — table of data, 600, 601
Material and workmanship specifications, 548-549
Mauer Dam, Germany, data, 601
Mead, D. W., book by, 63, 183
 — —, rainfall tables, 32
 —, Elwood, book by, 501
 — — bulletins by, 152, 246
Means, Thos. H., water investigations, 62
Measurement of irrigation water, 153-183
 — — water to the user, 164, 165
Measuring devices, 165-182
 — view of, detail of, 263
 — water, books on, 182-183
Medina Dam, Texas, data, 601
Meer Allum Dam, plans of, 472
Merced Dam, Cal., data, 599
 — River, flood and area, 593
Mercedes Dam, Mexico, data, 601
Mesquite, clearing land of, 104
Metal flumes, specifications, 576-579
 — work, specification clauses, 545, 546
Meters for measuring water, 155-163
 — water works not suitable, 172
Meyer, A. F., book by, 495
 — — voids in rock, 491
Miami Valley floods, work of, 354, 355
Mill Brook, N. Y., flood and area, 595
 — Creek, Pa., flood and area, 594
Mineral food for plants, 23, 24
"Miner's inch," and duty of water, 149
 — — definition of, 165
 — — value of, 616
Minidoka Canal gate, 250
 — Dam, section of, 436
Minidoka project, lateral system, 218, 219
 — — silting canals, 244, 245
 — pumping plant, 93-95
 — Reservoir, area, cost, etc., 598
Minitare Dam outlet, illustrated, 362, 366
 — Reservoir, table data, 598
Missouri River, flow of, 43
"Modoc Lava Beds," leakage, 352
Moehne Dam, Germany, data, 601
Mohawk River, flood and area, 592
Moisture in soil, 16-21
Monocacy River flood and area, 593
Monongahela River, flow and area, 592
Montrose and Delta Canal headgates, 260
Morena Dam, data, 599
Morin's coefficients of friction, 448
Moritz, E. A., articles by, 183, 246
Morris Dam, Conn., data, 599
Morrison data on pressure, 447
Moselle River, France, flood, 595
 — Valley, value silt in, 25
Mosquitoes and irrigation, 5, 6
Mountain Dell Dam, Utah, data, 601
Mulching and alkali, 14
 — — evaporation, 66
Mullins, Lieut.-Gen. J., book by, 182
Murphy, D. W., article by, 201
 — E. C., bulletins by, 98, 183
Murgab Valley, abandoned lands, 185
 — — headgates in, 261
- N
- "N" value, Kutter's formula, 164, 602, 603**
Nadrai Aqueduct, India, 313
Narora weir, India, illustrated, 391
Narrows Dam, uplift data, 453
Navier's formula, arches, 469
Necaxa Dam, Mexico, data, 599
 — — — failure, 428, 429
Neches Canal pumping plant, 98
Needle valves, illustrated, 362, 368
Neosho River, flood and area, 592
 — — flow of, 34, 43

Nettleton, E. S., book by, 64
 New Croton Dam. See Croton Dam.
 New Dam, Mexico, data, 601
 New Hauser Dam, Mon., data, 601
 New River, flood and area, 592
 Newell, F. H., artesian well report, 64
 — — article by, 6
 — — books by, 98, 152, 527
 — — report by, 183
 Newell and Murphy, book by, 98
 Nicaragua, report on hydrography of,
 380
 — — of rainfall, 357
 — — silt experiments, 374-376
 Night irrigation, 511, 512
 Nile, barage on, at Cairo, 387
 — Valley, silt irrigation in, 25
 Nitrates and plant food, 23, 24
 Nitrogen and plant food, 24
 Norwich Water Co., Dam, section, 477
 North Platte. See also Interstate
 Canal
 — — Whalen Dam, 257, 259
 — — River, flow of, 44
 Notch drop, India, illustrated, 284
 — — Interstate Canal, 286
 Nurse crop of alfalfa and rye, 105, 106

O

O'Shaughnessy, M. M., article by, 98
 Ocmulgee River flood and area, 592
 Oconee River, flood and area, 594
 Oder Dam, Germany, data, 601
 — River, Germany, flood, 595
 Ohio River, flow of, 592
 Oil lining, canals, coefficient, 235
 Okanogan Canal, lining, illustrated,
 . 321
 — project, chute, 294
 — — irrigation methods, 513
 — tunnel data, 334
 Okhla weir, India, illustrated, 391
 Old Croton Dam. See Croton Dam.
 Olive Bridge Dam, N. Y., data, 601
 — — — — pressure on foundation, 447
 Ontario Colony, Cal., water supply, 59
 Open and closed weirs, 386-388

Open drains, definition of, 191
 Operation and maintenance, chapter
 on, 502-527
 — — — charges, U. S. R. S., 146
 Optimum water supply, 18-20
 Orange grove irrigation, illustrated, 122
 Oregon, water supply of, book on, 63
 Organization, specifications of, 535, 536
 Orifices, measuring 168-172
 — — formulæ, 179
 — — table, 180, 181
 Orland project, lined canal, O. & M.
 costs, 242. See also East Park
 Dam.
 Orme, Dr. H. O., investigations of, 5
 — S. H., sewage irrigation book, 64
 Otay Dam, core wall, 438, 440
 — — failure of, 441
 — — lower length, height and volume,
 599
 — — views of, 439, 440, 471
 Outlet works, reservoir, 358-369
 Overfall dams, illustrated, 475, 490
 Overhaul, specification clause, 558
 Overshot water-wheels, 81, 82
 Overturning, failure of dams by, 449
 Owl Creek Dam, gravel blanket, 436
 — — — material used, 423
 — — — outlet works, 359
 — — — paving, illustrated, 418
 — — — section of, 406. See also Belle
 Fourche.
 Owyhee River, flow of, 43

P

Pacific Slope, rainfall on, 32-34
 Pacoima Creek, dam on, 403
 Paris, deep well in, 50
 Pas Du Riot Dam, France, data, 601
 Pasadena, Cal., sewage irrigation, 130
 Passaic River, flood and area, 593
 Patents, specification clause, 553, 554
 Pathfinder Dam, Wyo., data, 601
 — — — view of, 470
 — Reservoir, area, cost, etc., 598
 Pecos Irrigation Co., canals, leakage,
 227

- Pecos River, flow of, 44
 — —, Lake McMillan, 349
 — Valley Dams, data, 509
 Pelton water wheels, 84
 Peguonnock River, flood, 594
 Percolation of water in dams, 417-423
 — — — in soils, 48
 — — — rate of, 46, 47
 — — — views of, 123
 Periar Dam, India, data, 601
 — — — section, 463
 Permeability of soils, table, 47
 Persia, records of irrigation in, 2
 Peru, area irrigated in, 4
 Philippines, area irrigated in, 4
 — rainfall records, 356
 Piche evaporimeter observations, 68
 Pilarcitos Dam, data, 599
 Pile weirs described, 384, 387
 Piling, specification clause, 544, 545
 Pinal Creek, flood and area, 594
 Piñon, clearing lands of, 105
 Pipe, concrete, specifications, 574-576
 — formulæ discussed, 326, 330
 — irrigation, sub-irrigation, 134, 135
 — manufacture, illustrated, 328, 329
 — steel, specifications, 572-574
 — turnouts, U. S. R. S., plans, 266
 — vitrified, specifications, 590, 591
 — wood stave, specifications, 567-571
 Pipes, concrete, metal and wood, 323-330
 — flow of water in, paper on, 183
 Piscataquis River, flood, 594
 Pishkun tunnels, data, 334
 Plant food, chapter on, 22-26
 — growth and water, 22, 23
 Platte River, cribwork on, 59, 60
 Plowing as remedy for alkali, 13
 Po Valley Canal structures, Italy, 298
 Pocollet River, flood and area, 594
 Pomona, Cal., irrigation at, 98
 Pompton River, flood and area, 594
 Poncelot water wheels, 81
 Potassium and plant food, 23, 24
 Potholes in canals, 224, 225
 Potomac River, flow and area, 592
 Powder River, flow of, 43
 Powell, J. W., report on wells, 64
 Précipitation charts of U. S., 36
 — in U. S., maps of, 29-31
 Prehistoric irrigation works, 2
 Preparation of land for irrigation, 104-110
 — — — — — and duty, 140
 Preparing land, bulletin on, 136
 Pressures on masonry, table, 447
 — — — dams, 444-447
 Price current meter, 155-157
 Price River, flow of, 44
 Priming canals, Grand Valley, 243, 244
 "Principles of irrigation practice," book, 6
 "Private vs. Federal irrigation," 6
 Profits of irrigation discussed, 4, 5
 Progress of work, specification clause, 536
 Project manager, duties of, 502
 Proposal, specification clauses, 547
 Prosser siphon and bridge, illustrated, 327
 Protection of earth dams, 413-417
 Protection of work, specification clause, 553
 Provo River, flow of, 44
 Puddling, cost in lining canals, 243
 — specification clause, 559
 Pumping, books on, 98
 — for irrigation, 73-98
 Pumps, centrifugal, 86-90
 Purchase specifications, 555-556
 Putah Creek, flood and area, 593, 594
- Q
- Quantities, specification clause, 552
 Queis River, Germany, flood, 595, 596
- R
- Rafter, Geo. W., book on sewage, 64
 Rainfall and duty of water, 138, 139
 — books on, 63, 64
 — character of, 41
 — discussion of, 27-37
 — excessive, records, 356, 357
 — government projects, 145
 — of Cal., report on, 64

- Rainfall records, tables, 356, 357
 — runoff and, 40, 41
 — U. S. maps of, 29-31
 Ram. See Hydraulic ram, 91, 92
 Ramapo River, flood and area, 594
 Rands, H. A., paper by, 495
 Raritan River, flood and area, 593
 Rating curve for stream measurement, 162
 Rawhide crossing, illustrated, 317
 "Reclaiming the arid West," book, 6
 Reclamation Act, passage of, 3
 "— Record," article on water, 152
 Reclamation Service, canal linings, 238-244
 — — canals, table of, 230-232
 — — drainage problem, 185
 — — drains, table of, 200, 201
 — — duty of water, 144, 145
 — — O. & M. charges, table, 146
 — — pipe formulæ, 330
 — — pumping plant, 90
 — — reservoirs, 598
 — — spillway standards, 272, 273
 — — turnouts, plans, 266-270
 Reconnaissance of project, 528
 Recording water meters, 172-179
 Redwood for pipe discussed, 324
 Regulator gates, canal, 250-256
 Reinforced concrete dams, 478-487
 Reinforcement bars, specifications, 559, 562
 Remedies for alkali, 12-15
 Remscheid Dam, table of data, 601
 Reports and estimates, specifications, 536
 Reservoirs, built by U. S. R. S., table, 598
 — storage, chapter on, 342-369
 Residual soils, definition of, 7
 Return flow measurements of, 245, 246
 Returns of irrigation, 4, 5
 Rhine River, Switzerland, flood, 595
 Rice irrigation, 97, 98
 — — pumping for, 86
 — production in U. S. by States, 97
 Right of way, specification clause, 553
 Rio Das Lages Dam, data, 601
 Rio Grande, bulletin on, 63
 — — flow of, 42-44
 — — silt, book on, 26
 — — —, data, 25, 371, 372
 — — — deposits, 377-379
 — —, Panama, flood, 595
 — — Valley, duty of water in, 147
 — — — seepage, 185
 — — — water fluctuation, 187
 — — — wells in, 58
 Rio Mora, flood and area, 593, 594
 Riparian doctrine of water right, 496
 River discharge, books on, 63
 Riverside, Cal., irrigation illustrated, 115, 122
 Rivers, flood discharge table, 592-596
 Road crossings, 335-337
 Roads and fences, specification clause, 553
 — on canal banks, 210
 — specification clause, 537
 Rockfill, specification clause, 545
 — dams, 436-441
 — table of, 599
 Rock sections of canals, 207, 208
 Roller dams, illustrated, 394-400
 Rolling earth dams, 425, 426
 — — — view of, 427
 Rondout Creek, flood and area, 594
 Rookery Building. Chicago, pressure, 447
 Roosevelt Dam, plan and section, 467, 468
 — — table of, data, 601
 — — pressure on, 447
 — Reservoir, area, capacity, etc., 598
 Rotation system of irrigation, 182, 512-514
 Run-off, laws of, 40-45
 Russell, T., evaporation experiments, 68
 Russia, area irrigated in, 4
 Russian thistle, pest of, 524, 525
 Rye as a nurse crop, 106
 Ryves, Col., discharge formula, 597
- S
- St. Louis Bridge, pressure on, 447
 St. Louis, deep well in, 51

- St. Mary Lake Dam, mixture, for, 420
 St. Paul's, London, pressure on, 447
 St. Peter's, Rome, pressure on, 447
 Sacaton grass and alkali, 10
 Sacramento River, flow and area, 592
 — — flow studied, 42, 354
 Safety conditions of dams, 381, 382
 Sagebrush indication of fertility, 102, 104
 Sahara Desert, waters of, 62
 Salinas Valley, Cal., report on, 64
 Salmon River, current wheel on, 89
 — — Dam, data, 601
 — — — design, 472, 473
 Salt-bush and alkali, 13
 Salt Lake, origin of irrigation at, 2
 Salt River, flow and area, 592
 — — hydrograph of, 35, 42
 — — Project, irrigation, 513
 — — Valley, court decision, 149
 — — — duty water in, 147
 — — — irrigation, illustrated, 122, 124
 — — value of silt of, 25
 Salton Sea, evaporation on, 72
 Salts, injurious, and alkali, 8-15
 San Andres Dam, data, 599
 San Carlos Project report, 380
 San Diego flume, Cal., 302
 San Fernando submerged dam, 403
 San Gabriel River, flood and area, 594
 — — — flow of, 42
 San Joaquin River, flow of, 33, 42
 — — River, flood and area, 593
 — — Valley, windmills in, 75
 San Jose Dam, Mexico, data, 601
 San Luis Rey, Cal. River, flood, 593
 — — Valley, abandoned lands, 185
 — — — sub-irrigation, 133, 134
 San Marcial, Rio Grande, silt at, 372
 San Mateo Dam, Cal., data, 601
 — — — plans and section, 466
 San Pablo Dam, data, 599
 San River, Austria, flood, 595
 Sand, specifications, 560
 Sand boxes, illustrated, 338-340
 Sand traps, canal, 337-341
 — — and manholes, 197
 Sandstone, pressure on, 447
 Sandy land in soil surveys, 103
 Sandy regions, clearing of, 105-106
 Sanitary works, books on, 64
 Sanitation, specification clause, 553
 Santa Ana Canal lining, 237, 240
 — — — sand box, 338
 — — flume, Cal., 302, 304
 — — River, flow of, 42
 Santa Catarina River, flood, 593
 Santa Ysabel Creek, flood, 594
 Saturation of earth dams, 409-411, 419-423
 — — hydraulic fill-dams, 428
 — — soil discussed, 19
 Savannah River, flow and area, 592
 Saw, submarine, weeds, 523
 Sawmill, specification clause, 537
 Schantz, H. L., book by, 25
 Scheidenhelm, F. W., paper by, 405
 Scheidenhelm's coefficient of friction, 448
 Schlichter & Wolf, book by, 98
 Schlichter's experiments on soils, 48
 Schoharie Creek, flood and area, 593
 Scioto River, flood and area, 593
 Schuyler, J. D., book by, 380
 — — gates designed by, 360-362
 — — pressure data, 447
 Scobey, F. C., bulletin by, 183
 Scoop wheels, 90, 94, 95
 Scraper, Fresno, view of, 109
 — slip, illustration of, 106
 Screw pump, 87
 "Seal," water, of tunnel, 331
 Season, length, and duty of water, 138
 "Second foot," definition of, 165
 — — table of equivalents, 616
 Sections of canals, illustrated, 204
 Sediment rolled along bottom, 373-376
 Sedimentation of Reservoirs, 370-380
 — tank for sewage, 131
 Sediments, fertilizing effect of, 25
 Seepage in dams, 417-423
 — formulæ, 235
 — losses, canal, 202, 234-236
 — reservoir, discussed, 346-354
 — Rio Grande Valley, 147
 — signs of, 185-191
 Seine, open weirs on, 387, 394

- Seligman Dam, Ariz., data, 601
 Seros Project Dams, data, 599
 Settlement of lands, Grand Valley, 225
 Sevier River, flow of, 44
 — — Dam, data, 599
 Sewage disposal, 123-127
 — farms, laying out of, 130-133
 — fertilizing, effect of, 128, 129
 — irrigation, 125, 127, 128
 — — books on, 64
 — — health and, 129, 130
 "Sewage purification in America," 63
 Sheep used in clearing canals, 525
 Shendoah River, flood and area, 592, 593
 Sherburne Lake Dam material, 423
 — — — section, 434
 Shifting channels and stream measurements, 159
 Shoshone Dam, Wyo., data, 601
 — — — diagram, 474
 — — — pressure, 447
 — Desert before and after, 100, 101
 — Project, Corbett Dam, 248, 249
 — Reservoir data, 598
 — tunnel, data, 334
 Shutters, automatic, illustrated, 392, 393
 Siam, area irrigated in, 4
 Sickness. See Health and Malaria.
 Side slopes of canals, 209
 Sierra Nevada Mts. and rainfall, 33
 Signature, specification clause, 547
 Silt allowance in canal design, 203
 — bearing water, effect of, 25
 — books on, 380
 — conditions, Imperial Valley, 222
 — deposits in canals, 520, 521
 — removal from reservoirs, 376-380
 — table of weight of, 371
 Silting leaky canals, 244, 245
 — of reservoirs, 370-380
 Sink holes, leakage from, 350
 — — in canals, 224-227
 Siphon spillways, illustrated, 275-277
 Siphons, large canal, 317-320
 Six-mile Creek, flood and area, 594
 Six-tenths of depth method of measuring stream flow, 158
 Slichter, C. S., underground waters, 64
 Slichter's percolation experiments, 419
 Sliding failure of dams, 447-449
 Slides of canal banks, 526, 527
 Slip scraper, illustration of, 106
 Slope of lands for irrigation, 100
 Slopes of earth dams, 409-417
 Sluiceway, Lower Yellowstone, illustrated, 340
 — standard design, 278
 Snake River, flow of, 43
 — — Canyon, leakage to, 351
 — — Dam, section of, 436
 — — power plant on, 93-95
 Snow and ice, evaporation on, 68
 Snowfall, effect on stream flow, 37, 38
 Soane Canal sluice gate, illustrated, 395
 — weir flashboards, illustrated, 392
 Sodium carbonate, effects of, 11
 — sulphate and alkali, 14
 Sodom Dam, N. Y., data, 601
 Soil conditions and rainfall, 41
 — moisture, chapter on, 16-21
 — survey of lands, 101-103
 Soils and duty of water, 139
 — books on, 15
 — chapter on, 7-15
 Somerset Dam, data, 599
 Sorgues River, waters for irrigation, 25
 South America, area irrigated, 4
 South Dakota, largest well in, 51
 South Platte River, flow of, 42
 — — — seepage to, 245
 Spanish irrigation systems, 2
 Spaulding Dam design, mention, 473
 Specifications, chapter on, 534-591
 Sprenburg deep well, 51
 Spiers Falls, N. Y., Dam, data, 601
 Spillway, East Park Dam, 485
 — provisions, 354-358
 Spillways, canal, illustrated, 271-282
 Spiral lap seam pipe, 326
 Sprague River Dam, view of, 258
 Spring Canyon flume, 303, 308, 310
 Spring Valley Water Co. well experiments, 59

- Springs in foundation of dams, 408, 409
 Sprinkling earth dams, 425, 426
 Spokane River, flow of, 44
 Spou, Ernest, book on wells, 64
 Stanislaus River, flood and area, 593
 Stanley, F. W., book on Florida, irrigation, 136
 Starch Factory Cr., Conn., flood, 595
 Stave pipe specifications, 566-571
 Steam-power pumping engines, 86
 Steam R.R., specification clause, 537
 Steel bars, specifications, 562, 563
 — bridges, specifications, 579-584
 — castings, specifications, 564
 — dam used in irrigation, 113
 — dams, illustrated, 487-490
 — flumes, 303-308
 — lined canal, Egypt, 241, 242
 — mild, effect of alkali on, 309
 — pipe, discussed, 325, 326
 — — specifications, 572-574
 — structural, specifications, 561, 562
 Stevens automatic stream gage, 160
 Stilling basin and drop, 291
 Stony Cr., Cal., flood and area, 593
 Stony River Dam, paper on, 495
 Storage dams, illustrated, 404-436
 — reservoirs, chapter on, 342-369
 — — U. S. R. S., table, 598
 — water and evaporation, 70, 71
 Stove pipe method of well drilling, 57
 Strange, W. I., book on India, 380
 Strawberry Dam, section of, 410
 — Reservoir, data, 598
 — tunnel, data, 334
 — Valley flume, illustrated, 310
 — — lined canal, illustrated, 336
 Stream flow, discussion of, 37-40
 — — records in U. S. tables, 42-44
 — measurement methods, 153-157
 Structures, canal, chapter on, 247
 Subgrade of canals, 210-212
 Sub-irrigation discussed, 133-136
 Submarine saw for weeds, 523
 Submerged dams, illustrated, 402-404
 — weir, measuring water, 166
 Subsidence, Grand Valley lands, 225
 Sub-surface water sources, 45-48
 Sugar beets and alkali, 10
 Sugar Loaf Dam, data, 599
 Sulphur Creek wasteway, 293
 Sunland River, flood and area, 595
 Sunlight in arid regions, 2
 Sunnyside Canal, dimensions, 232
 Sun River tunnels, data, 334
 Superpassage, Ganges Canal, illustrated, 311
 Suppressed orifice, definition, 169
 Survey of reservoir sites, 353, 354
 — stakes, specification clause, 553
 Surveys of a project, 528-533
 Suspension of contract, specifications, 549
 Susquehanna River, flow and area, 592
 Swamp reclamation and drainage, 185
 Swanzy Dam, Wales, data, 601
 Sweetwater Dam, Cal., data, 601
 — — — spillway, 354, 355
 — Reservoir, seepage into, 246
 — — flood and area, 594
 Sweetwater valve plug, illustrated, 362
 Swingle, Z. T., bulletin by, 26
 Synclinal Valley as reservoir site, 345
- T
- Tait, C. E., bulletins by, 98, 136
 Talbot, A. N., article by, 63
 Talla Dam, Scotland, data, 599
 Tannatt and Kneale, bulletin by, 201
 Tansa Dam, India, data, 601
 — River, India, flood and area, 596
 Teele, R. F., book on land, 136
 — — report by, 152
 Telephone, specification clause, 537
 — system specifications, 586-590
 Tennessee River, flow and area, 592
 — — Little, flow and area, 593
 Tension in masonry discussed, 465
 Ternay Dam, Fr., data, 601
 Terraced hillside irrigation, illustrated, 120, 121
 Texas, rice irrigation in, 97, 98
 Theresa concrete weir, section, 486
 Thompson, S. E., book by, 495
 Three-mile Falls Dam, plans and section, 483

Throttle Dam, data, 599
 Tieton Canal flume plans, 297
 — — lined canal, 211, 213
 — — — section, illustrated, 241, 281
 — — steel flume, 306
 — — tunnels, data, 334
 Tile drains, sizes of, 191-193
 — used in drainage work, 196, 197
 — — — sub-irrigation, 134, 135
 Timber, specification clause, 544
 — dams, 382-384
 Titicus Dam, N. Y., data, 601
 Titles, water, 496-501
 Toccoa River, flood and area, 594
 Toncan metal, alkali and, 309
 Topography and rainfall, 41
 — of irrigable lands, 99-101
 Trapezoidal channels, table data, 611
 Trench excavator for drainage, 192
 Trenching machinery, bulletin on, 201
 Triunfo Creek Dam, Cal., data, 601
 Truckee Canal drop, illustrated, 283
 — — lining, view, 240
 — — wasteway, illustrated, 279
 — River, flow of, 43
 Tsar Canal, Turkestan, 261
 Tucson, Ariz., sewage irrigation at, 128
 Tugaloo River, flood and area, 593
 Tule Lake, leakage from, 352
 Tumalo Reservoir, leakage, 346, 347
 Tumble weeds in canals, 194
 Tunneling for water, 59-61
 Tunnels, discussion of, 330-335
 — specification clause, 538
 — specifications, 584-586
 — table length and cost, 334
 Tuolumne River, flow of, 42
 — — flood and area, 593
 Turbine water wheels, 82, 83
 Turkestan, abandoned lands in, 185
 — gates and headgates in, 261
 Turlock Canal, cross-section, 207
 Turnouts, lateral canal, 263-271
 Turtle Creek, flood and area, 594
 Twin Falls canals and leakage, 227
 — — reservoir leakage, 351
 Tygart River, flood and area, 593
 Typhoid fever and sewage irrigation, 129

U

Ubaya River, France, flood and area, 595
 Umatilla by-pass drop, 288
 — Canal lining, view, 239, 243
 — — — section, 208
 — Project, duty of water on, 147
 — River, flow of, 43
 Uncómpahgre tunnels, data, 334
 — Valley drops, 290
 — — duty of water in, 147
 — — flume, illustrated, 322
 Underflow tests, bulletin on, 63
 Underground irrigation, 135, 136
 — waters, 45-48
 — — books on, 63, 98
 Undershot water wheels, illustrated, 78-81, 89
 Unit prices, specification clause, 552
 United States, area irrigated in, 4
 Uplift, hydrostatic on dams, 451-453
 Upper Deer Flat Embankment section, 416
 Urft Dam, Germany, data, 601
 Urnasch River, Switzerland, flood, 596
 Use of water, doctrine of, 496, 499
 Use of Water in Irrigation," book, 6
 Utah experiments on duty of water, 141-143
 — rules for irrigation, 150-152

V

"V" ditcher, illustration of, 107
 Valve plugs, cast iron, dams, 362
 Valves, butterfly and needle, 362-369
 Van Buren's stability of dams, 451
 Vapor engines for pumping, 84, 85
 Vegetation and rainfall, 41, 42
 — in canals, clearing, 521-524
 Velocity head tables, 614
 — in canals, discussion of, 215-217
 — of approach to weirs, 168
 — tables, flow of water, 602-610
 Ventilation of tunnels, 333
 Venturi flume, 178, 179
 — water meter, 177, 178
 — — — formula, 178

Verdun River, France, flood, 595
 Victor turbine water wheel, 83
 Villar Dam, Spain, data, 601
 Vistula River, Galicia, flood, 595
 Vitrified pipe, specifications, 590, 591
 Vogesen Mts., rainfall in, 32
 Voids in stone, 491, 492
 Volume of Dams, table of, 599-601
 Vyrnwy Dam, Wales, data, 601
 — — pressure on foundation, 447

W

Waco, Tex., artesian area, 51
 Wachusett Dam, data, 601
 — Reservoir, permeability, 47
 Waldeck Dam, Ger., data, 601
 Walnut Canyon Reservoir leakage, 350,
 351
 Walnut Grove Dam, failure of, 441
 Wanague River, flood and area, 594
 War Department report, San Carlos, 380
 "Wash borings," dam foundations, 494
 Washington Monument, pressure on,
 447
 Waste water, discussed, 511, 512
 Wasteways, discussion of, 277, 278
 Water and plant growth, 22, 23
 — application of, to land, 111-136
 — character of, 61-63
 — concrete specification clause, 560
 — consumed by crops, table, 23
 — economy discussed, 504-511. See
 Duty of Water.
 — Law, books on, 501
 — logged lands, 184, 185
 — — San Louis Valley, 133, 134
 — measurement, chapter on, 153-183
 — proofing dams, by gunnite, 453
 — rights, chapter on, 496-501
 — supply and plant life, 18-20
 — — chapter on, 27-64
 — — investigation of, 528-529
 — table, effect of rise of, 10, 11
 — — rise of, 184, 185
 — users, cooperation with, 504
 — waste discussed, 511, 512
 — wheels, pumping, books on, 98
 — — pumping with, 78-84

Water works meters not suitable, 172
 Wave action on gravel slope, 417
 Weather Bureau, evaporation table, 72
 Weber River, flow of, 44
 Weeds, clearing canals of, 521-524
 Weep holes, concrete canal lining, 237
 Wegmann, Edward, book by, 495
 Weight, various substances, table, 615
 Weights and measures equivalents, 616,
 617
 Weir formulæ, 167, 168
 Weirs and coefficients, books on, 182,
 183
 — measuring water by, 166-168
 — or diversion dams, 382-404
 — various kinds described, 384-391
 Weisbach, P. J., book by, 183
 — — pipe formula discussed, 326
 Weiser River, flow of, 43
 Wells, artesian, 48-59
 — books on, 63, 64
 — deep, examples of, 50, 51
 — in dams, drainage, 454
 — in drainage ditches, 194
 — irrigation from in India, 58
 Werre River, Germany, flood and area,
 595
 West Gallatin River, flow of, 43
 Whalen Dam, views of, 257-259
 Wheel scraper, view of, 425
 Wheels, water, for pumping, 78-84
 Whippany River, flood and area, 594
 White Nile, irrigation water of, 25
 Widtsoe, John A., book of, 6, 25, 26, 152
 — — bulletin on evaporation, 71
 — — O. & M. conclusions, 511
 — — plant water, data on, 23
 Wigwam Dam, Conn., data, 601
 Willamette River, flow of, 43
 Willcocks, Sir William's visit, V
 Williams Dam, Ariz., data, 601
 Willow Cr., Ore., flood and area, 594
 Wilson, H. M., books of, 6, 26, 152
 — — bulletin by, 98
 — — first edition by, V
 Wilting coefficient, definition of, 20
 Wind and evaporation, 68
 — erosion of canal banks, 524, 525

- Windmills, books on, 98
 — capacity table, 77, 79
 — for irrigation, 75-78
 Wind pressures, tables of, 76, 77
 Winter operation of canals, 516-518
 Wire reinforcement, pipe, illustrated, 328
 — wound wooden pipe, 324
 Wofelsbrund Dam, Ger., data, 601
 Wolff, A. R., book on windmill, 77
 Wolny, data by, on plant water, 23
 Wood stave pipe siphon, illustrated, 312
 — — — specifications, 566-571
 Wooden drains, use of, 198
 Workmen, specification clause, 552
 Workmanship, specification clause, 548, 549
 Wupper River, Germany, flood, 595
- Y
- Yadkin Narrows Dam, data, 601
 — River, narrows dam at, 453
- Yakima County, water appropriation, 498
 — River, flow of, 44
 — tunnels, data, 334
 — Valley, analysis soils of, 9
 — — furrow, irrigation, 118
 — — hydraulic rams, 92
 — — siphon, illustrated, 327
 Yarnell, D. L., bulletin by, 201
 Yellowstone Dam, lower, 387
 — River, flow of, 43
 Youghiogheny River, flood and area, 593
 Yuba River, flood and area, 593, 594
 Yuma, Ariz., furrow irrigation, illustrated, 119
 — Canal headgates, illustrated, 251, 253, 256
 — — siphon spillway, 276
- Z
- Zola Dam, Spain, data, 601
 Zuni Dam failure, 352

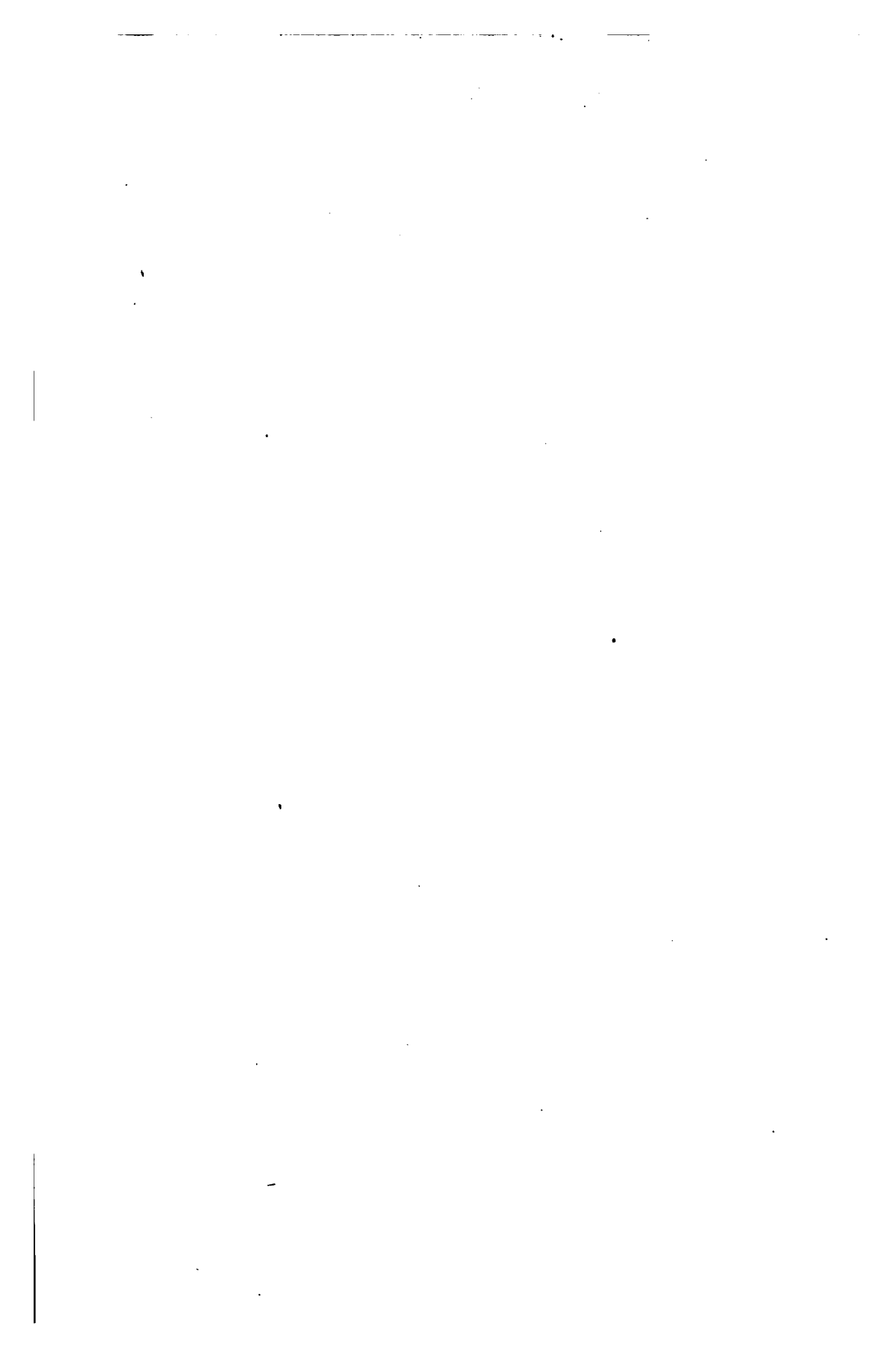

This book may be kept

89088901988



B89088901988A